

# DOGM204-A

## 4x20 INCL. CONTROLLER SSD1803A for 4-/8 Bit, SPI, I<sup>2</sup>C

available for 1 pc. off !  
even with LED: 5.8mm flat

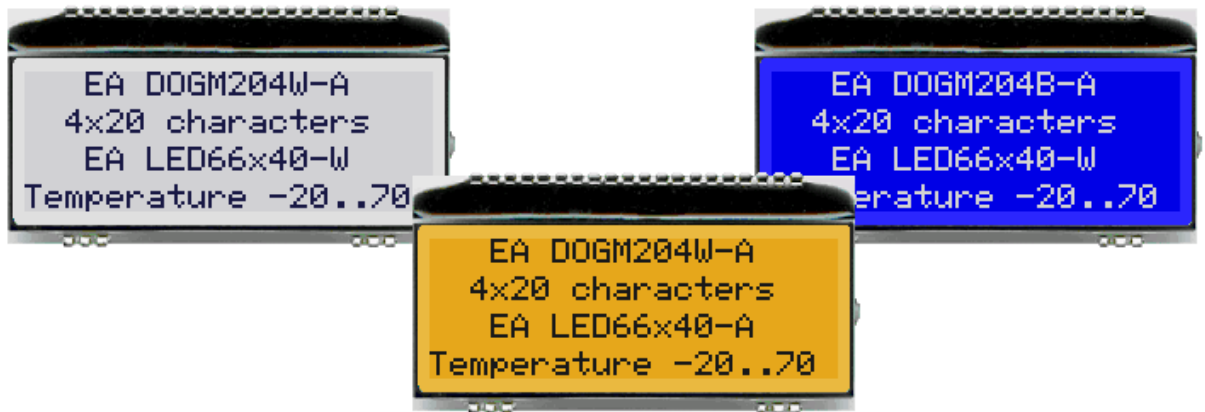

### FEATURES

- \* HIGH-CONTRAST LCD SUPERTWIST DISPLAY
- \* OPTIONAL LED BACKLIGHT UNITS IN DIFFERENT COLORS
- \* 4x20 CHARACTER WITH 4.8 mm HEIGHT
- \* SSD1803A CONTROLLER FOR 4-/8-BIT, SPI (2-/3-/4-WIRE) AND I<sup>2</sup>C (2-WIRE) INTERFACE
- \* SINGLE POWER SUPPLY +3.3V (typically 250µA)
- \* NO ADDITIONAL VOLTAGES REQUIRED
- \* OPERATING TEMPERATURE RANGE -20 THROUGH +70°C
- \* LED BACKLIGHT 3 through 80mA@3.3V or 2 through 40mA@5V
- \* NO MOUNTING REQUIRED, SIMPLY SOLDER INTO PCB
- \* 3 DIFFERENT CHARACTER SETS (CYRILLIC, ENGLISH-JAPANESE AND EUROPEAN) INCLUDED IN THE SAME CONTROLLER
- \* 2 VIEWING DIRECTION POSSIBLE (BOTTOM AND TOP VIEW)

### ORDERING CODE

LCD MODULE 4x20 - 4.8 mm

x: *B* = blue background

*W* = white background transfective

*S* = black background

*N* = white background reflective

LED BACKLIGHT, WHITE

LED BACKLIGHT, AMBER

LED BACKLIGHT, GREEN/RED

USB TEST BOARD FOR PC (WINDOWS)

SOCKET CONNECTOR 4.8 mm HIGH (1x22-PIN, 2.54mm PITCH)

**EA DOGM204x-A**

**EA LED66X40-W**

**EA LED66X40-A**

**EA LED66X40-GR**

**EA 9780-4USB**

**EA FL-22P**

## EA DOG SERIES

With its EA DOG series, ELECTRONIC ASSEMBLY presents the world's first display series which will run on 3.3 V systems without auxiliary power.

Unlike normal LCD modules, you order the display and the corresponding backlight separately. This gives you a wealth of possible combinations.

Designed for compact hand-held devices, this modern LCD range provides a number of real benefits with or without backlight:

- \* extremely compact at 66 x 40 mm at the standard font size of 4.8 mm (4 x 10)
- \* ultra-flat at 2.0 mm without backlight or 5.8 mm including LED backlight
- \* 4-bit, 8-bit, SPI interface (2-/3-/4-wire) and I<sup>2</sup>C (2-wire)
- \* typical power consumption of only 250µA in full operation (LED white backlight as of 3mA)
- \* easy installation by simply soldering into the board
- \* A whole range of design variants can be supplied as of single units
- \* Changing background color

## LED BACKLIGHTS

5 different variants are available for individual backlighting: white, yellow/green, red, amber and bi-color.

For monochrome backlights, 2 separate LED paths are available, which can be switched in parallel or in series to ideally match the system voltage. This means that all the backlights can be run either at 3.3 V and higher voltages.

Operation of the backlight requires an external series resistor for current limiting. This can be calculated by  $R=U/I$ ; you will find the values in the table. To improve life time it is recommended to use a current source only.

The operating life of the yellow/green, red and amber backlights is 100,000 hours and that of the white backlight is a bit shorter.

**Important:** Never operate the backlight directly on a 5 V/3.3V supply, as this can immediately destroy the LEDs!

## INSTALLATION

First, the display and the corresponding backlight are clipped together. The complete unit is then inserted into a PCB and soldered. Note that the 4 pins for the backlight must also be soldered from the top with less tin.

**Important:** There are one or two protective films on the display (top and/or rear side) and one on each backlight. Those have to be removed during or after production.

amber EA LED66x40-A	Forward voltage	Current max.	Limiting resistor	
			@ 3,3 V	@ 5 V
Connected in parallel	2,1 V	72 mA	18 ohm	47 ohm
Connected in series	6,3 V	24 mA	-	-

white EA LED66x40-W	Forward voltage	Current max.	Limiting resistor	
			@ 3,3 V	@ 5 V
Connected in parallel	3,2 V	90 mA	1,2 ohm	24 ohm
Connected in series	9,6 V	30 mA	-	-

green/red EA LED66x40-GR	Forward voltage	Current max.	Limiting resistor	
			@ 3,3 V	@ 5 V
red path (ARG/CR)	2,1 V	80 mA	24 ohm	48 ohm
green path (ARG/CG)	2,1 V	80 mA	18 ohm	39 ohm

### 4 DIFFERENT TECHNOLOGIES

As a standard we provide 4 different technologies as STN and FSTN:

display type	technology	optional backlight	readability	display color non backlit	display color with backlit	recommended backlight color
	FSTN pos. transmissive	it's fine with and without backlight	readable even without backlight	black on white	black on backlight color	white, blue, RGB
	STN neg. blue transmissive	usage only with backlight	---	---	backlight color on blue background	white, yellow/green
	FSTN neg. transmissive	usage only with backlight	---	---	backlight color on black background	white, RGB
	FSTN pos. white reflective	no backlight possible	finest readable without backlight	black on white	---	---

### 3 DIFFERENT BACKLIGHTS

3 different backlight colors are available to match equipments design as much as possible. The most effective and brightest one is the white one EA LED66x40-W.



EA LED66x40-W  
White



EA LED66x40-A  
Amber

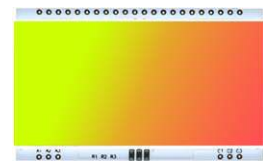

EA LED66x40-GR  
Bi-color green and red

When you can see black and white pictures only here on this page then you're able to download a coloured version from our website <http://www.lcd-module.de/eng/pdf/doma/dogm204e.pdf>

### USB-TEST BOARD EA 9780-4USB

For easy startup, a USB test board is available that can be connected to a PC. An USB cable and a Windows software is supplied with the product. This allows individual text and to be displayed directly on the connected display.

### SIMULATION WITH WINDOWS

Without ordering a display, the simulator software may show all the displays and colors even without the hardware. You can download for free from our website. There's no need to install:

[http://www.lcd-module.de/fileadmin/downloads/startdog\\_v46.zip](http://www.lcd-module.de/fileadmin/downloads/startdog_v46.zip)

**APPLICATION EXAMPLES**

Different wiring must be used depending on the interface.

Note that the COG technology means that the current capacity of the outputs is limited. Therefore, a large load on the bus may cause signal loops and unclear levels. If in doubt, additional pull-down resistors (8051) are required or additional waits/NOPs must be incorporated.

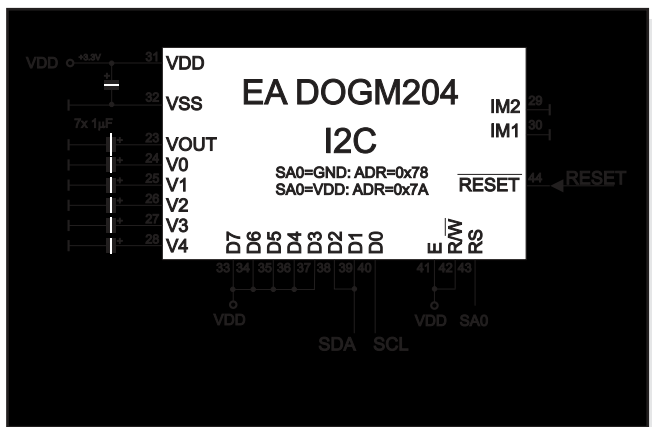
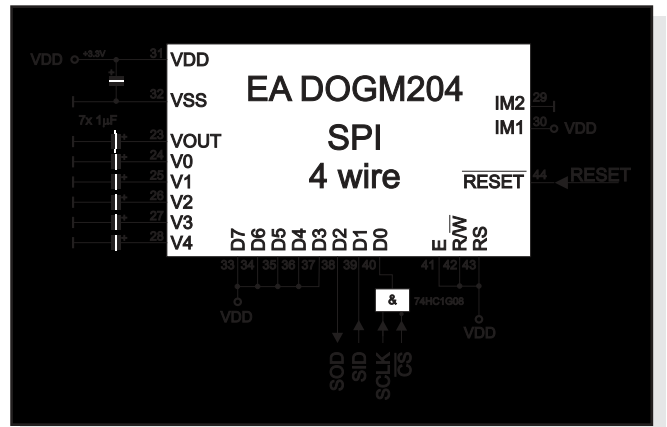
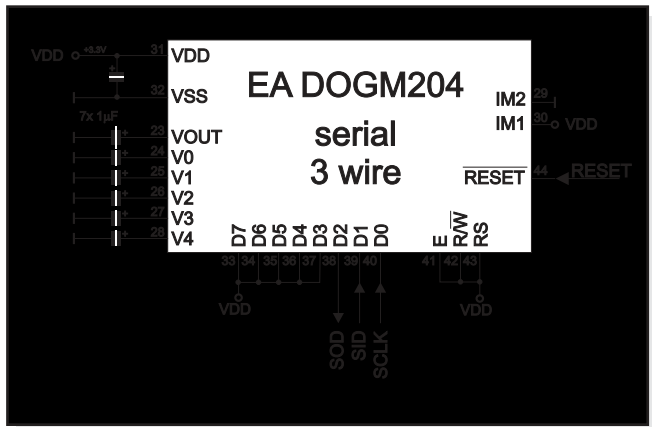
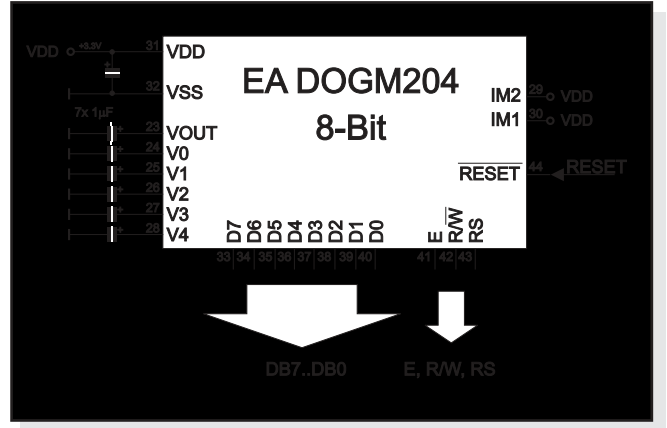
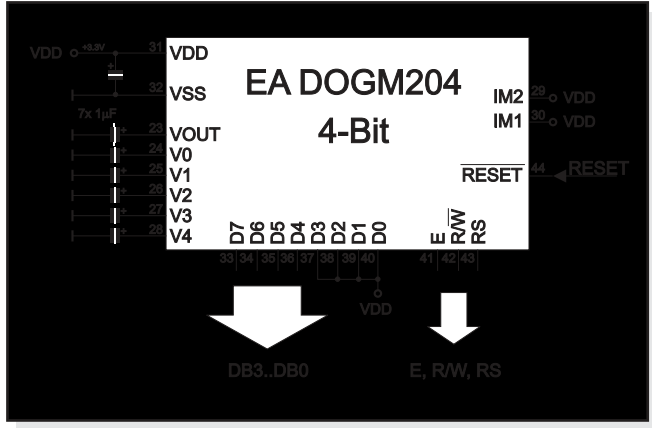

To guarantee an error-free functionality and initialization of display it is recommended to operate the reset input actively. This can be done via microcontroller port or external circuit. Here's an application example:

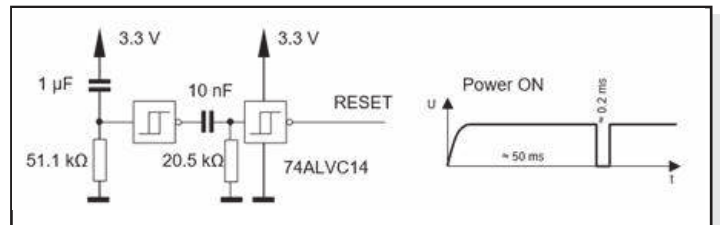

**INITIALISATION EXAMPLES**

Initialization Example 8-Bit, SPI and I2C												
Command	RS	R/W	DB7	DB6	DB5	DB4	DB3	DB2	DB1	DB0	Hex	Remark
Function Set	0	0	0	0	1	1	1	0	1	0	\$3A	8 bit data length extension Bit RE=1; REV=0
Extended function set	0	0	0	0	0	0	1	0	0	1	\$09	4 line display
Entry mode set	0	0	0	0	0	0	0	1	1	0	\$06	bottom view
Bias setting	0	0	0	0	0	1	1	1	1	0	\$1E	BS1=1
Function Set	0	0	0	0	1	1	1	0	0	1	\$39	8 bit data length extension Bit RE=0; IS=1
Internal OSC	0	0	0	0	0	1	1	0	1	1	\$1B	BS0=1 -> Bias=1/6
Follower control	0	0	0	1	1	0	1	1	1	0	\$6E	Divider on and set value
Power control	0	0	0	1	0	1	0	1	1	1	\$57	Booster on and set contrast (DB1=C5, DB0=C4)
Contrast Set	0	0	0	1	1	1	0	0	1	0	\$72	Set contrast (DB3-DB0=C3-C0)
Function Set	0	0	0	0	1	1	1	0	0	0	\$38	8 bit data length extension Bit RE=0; IS=0
Display On	0	0	0	0	0	0	1	1	1	1	\$0F	Display on, cursor on, blink on

Initialization Example 4-Bit									
Command	RS	R/W	DB7	DB6	DB5	DB4	Hex	Remark	
Synchronize 1	0	0	0	0	1	1	\$33	Make sure to switch to 8 bit data length	
			0	0	1	1			
Synchronize 2	0	0	0	0	1	1	\$32	Switch to 4 bit data length	
			0	0	1	0			
Function Set	0	0	0	0	1	0	\$2A	4 bit data length extension Bit RE=1; REV=0	
			1	0	1	0			
Extended function set	0	0	0	0	0	0	\$09	4 line display	
			1	0	0	1			
Entry mode set	0	0	0	0	0	0	\$06	bottom view	
			0	1	1	0			
Bias setting	0	0	0	0	0	1	\$1E	4 bit data length extension Bit RE=0; IS=1	
			1	1	1	0			
Function Set	0	0	0	0	1	0	\$29	4 bit data length extension Bit RE=0; IS=1	
			1	0	0	1			
Internal OSC	0	0	0	0	0	1	\$1B	4 bit data length extension Bit RE=0; IS=1	
			1	0	1	1			
Follower control	0	0	0	1	1	0	\$6E	Divider on and set value	
			1	1	1	0			
Power control	0	0	0	1	0	1	\$57	Booster on and set contrast (DB1=C5, DB0=C4)	
			0	1	1	1			
Contrast Set	0	0	0	1	1	1	\$72	Set contrast (DB3-DB0=C3-C0)	
			0	0	1	0			
Function Set	0	0	0	0	1	0	\$28	4 bit data length extension Bit RE=0; IS=0	
			1	0	0	0			
Display on	0	0	0	0	0	0	\$0F	Display on, cursor on, blink on	
			1	1	1	1			

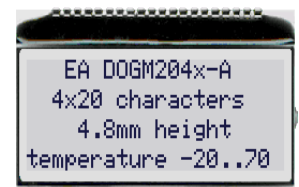

6 o'clock (Bottom View)



12 o'clock (Top View)

**12:00 VIEWING ANGLE, TOP VIEW OPTION**

If the display is read mostly from above (on the front of a laboratory power supply unit, for example), the preferred angle of viewing can be set to 12 o'clock. This rotates the display by 180°. A slightly different initialization setup is required for this.

**SETTING THE CONTRAST**

The contrast for the EA DOGM204-A can be set by command. This is done using bits C0 through C5 in the commands "Contrast Set" and "Power/Icon Control/Contrast Set". Generally, the contrast is set once only. Thanks to the integrated temperature compensation function it is kept constant allover the entire operating temperature range (-20 to +70°C).

Contrast set (8-Bit)												
Command	RS	R/W	DB7	DB6	DB5	DB4	DB3	DB2	DB1	DB0	Hex	Remark
Function Set	0	0	0	0	1	1	1	0	0	1	\$39	8-Bit data length extension Bit RE=0; IS=1
Power control	0	0	0	1	0	1	0	1	1	1	\$57	Booster on and set contrast (DB1=C5, DB0=C4)
Contrast Set	0	0	0	1	1	1	0	0	1	0	\$72	Set contrast (DB3-DB0=C3-C0)
Function Set	0	0	0	0	1	1	1	0	1	0	\$38	8-Bit data length extension Bit RE=0; IS=0

Further information about the commands of the SSD1803A, please refer to the datasheet: [http://www.lcd-module.de/fileadmin/eng/pdf/zubehoer/ssd1803a\\_2\\_0.pdf](http://www.lcd-module.de/fileadmin/eng/pdf/zubehoer/ssd1803a_2_0.pdf)

### CHARACTER SET

The controller has 3 built-in character sets. They can be selected with the command "ROM-Selection" in the extended command set.

#### ROM A

b3-0 b7-4	0	1	2	3	4	5	6	7	8	9	A	B	C	D	E	F
00																
10	▶◀▲▼※⊗⊙⊚⊛⊜⊝⊞⊟⊠⊡⊢⊣⊤⊥⊦⊧⊨															
20	!"#\$%&'()*+,-./															
30	0123456789:;<=>?															
40	ABCDEFGHIJKLMNO															
50	PQRSTUVWXYZÀÖÛÙ															
60	abcdefghijklmnopqrstuvwxyz															
70	parstuvwxyz{ }~															
80	0123456789:;<=>?															
90	ABCDEFGHIJKLMNO															
A0	abcdefghijklmnopqrstuvwxyz{ }~															
B0	0123456789:;<=>?															
C0	ABCDEFGHIJKLMNO															
D0	abcdefghijklmnopqrstuvwxyz{ }~															
E0	0123456789:;<=>?															
F0	ABCDEFGHIJKLMNO															

#### ROM B

b3-0 b7-4	0	1	2	3	4	5	6	7	8	9	A	B	C	D	E	F
00																
10	▶◀▲▼※⊗⊙⊚⊛⊜⊝⊞⊟⊠⊡⊢⊣⊤⊥⊦⊧⊨															
20	!"#\$%&'()*+,-./															
30	0123456789:;<=>?															
40	ABCDEFGHIJKLMNO															
50	PQRSTUVWXYZ[\]^_															
60	abcdefghijklmnopqrstuvwxyz															
70	parstuvwxyz{ }~															
80	0123456789:;<=>?															
90	ABCDEFGHIJKLMNO															
A0	abcdefghijklmnopqrstuvwxyz{ }~															
B0	0123456789:;<=>?															
C0	ABCDEFGHIJKLMNO															
D0	abcdefghijklmnopqrstuvwxyz{ }~															
E0	0123456789:;<=>?															
F0	ABCDEFGHIJKLMNO															

#### ROM C

b3-0 b7-4	0	1	2	3	4	5	6	7	8	9	A	B	C	D	E	F
00																
10	▶◀▲▼※⊗⊙⊚⊛⊜⊝⊞⊟⊠⊡⊢⊣⊤⊥⊦⊧⊨															
20	!"#\$%&'()*+,-./															
30	0123456789:;<=>?															
40	ABCDEFGHIJKLMNO															
50	PQRSTUVWXYZ[\]^_															
60	abcdefghijklmnopqrstuvwxyz															
70	parstuvwxyz{ }~															
80	0123456789:;<=>?															
90	ABCDEFGHIJKLMNO															
A0	abcdefghijklmnopqrstuvwxyz{ }~															
B0	0123456789:;<=>?															
C0	ABCDEFGHIJKLMNO															
D0	abcdefghijklmnopqrstuvwxyz{ }~															
E0	0123456789:;<=>?															
F0	ABCDEFGHIJKLMNO															

Change character table												
Command	RS	R/W	DB7	DB6	DB5	DB4	DB3	DB2	DB1	DB0	Hex	Remark
Function Set	0	0	0	0	1	1	1	0	1	0	\$3A	8-Bit data length extension Bit RE=1
ROM Selection	0	0	0	0	0	0	1	0	0	1	\$72	ROM selection double byte command \$00 = ROMA; \$04=ROMB; \$08=ROMC
	1	0	0	0	0	0	R2	R1	0	0	\$0X	
Function Set	0	0	0	0	1	1	1	0	0	0	\$38	8-Bit data length extension Bit RE=0

Example code

### CREATING YOUR OWN CHARACTERS

It's possible to create 8 own additional characters (ASCII Codes 0..7) to the fixed ROM codes. Please be informed, that RE- and IS-Bit need to be 0.

- 1.) The command "CG RAM Address Set" defines the ASCII code (Bit 3,4,5) and the dot line (Bit 0,1,2) of the new character. Example demonstrates creating ASCII code \$00.
- 2.) Doing 8 times the write command "Data Write" defines line by line the new character. 8th. byte stands for the cursor line.
- 3.) The new defined character can be used as a "normal" ASCII code (0..7); use with "DD RAM Address Set" and "Data Write".

Character-data								Hex	
Bit									
7	6	5	4	3	2	1	0		
			0	0	1	0	0		\$04
			0	0	1	0	0		\$04
			0	0	1	0	0		\$04
			0	0	1	0	0		\$04
X	X	X	1	0	1	0	1		\$15
			0	1	1	1	0		\$0E
			0	0	1	0	0		\$04
			0	0	0	0	0		\$00

Define own character													
Command	RS	R/W	DB7	DB6	DB5	DB4	DB3	DB2	DB1	DB0	Hex	Remark	
CG-RAM address set	0	0	0	1	AC5	AC4	AC3	AC2	AC1	AC0	\$40	Set address of character \$40=0; \$48=1;	
Character-data	1	0	x	x	x							\$04	first line
												\$04	second line
												\$04	third line
												\$04	fourth line
												\$15	fifth line
												\$0E	sixth line
												\$04	seventh line
												\$00	eighth line, cursor line

### SERIAL INTERFACE (SPI)

The serial interface always needs a synchronization byte. In write mode, the byte to send has to be divided in two bytes, into the "lower data" and "upper data". Please refer to the chart below. The maximum clock frequency for SCLK is 1 MHz.

#### SPI, 2-/3-WIRE

With 2 or 3 lines SCLK, SID and SOD (if necessary) the display EA DOGM204-A may be connected directly to the SPI interface of a  $\mu$ C.

#### SPI, 4-WIRE

If there is more than one component connected to the SPI, an additional „Chipselect“ line is required. For those you need to insert an AND-gate (e.g. 74HC1G08) with the SCLK line. On page 4 you do find an application example. Please mention that the logic for CS is H-active.

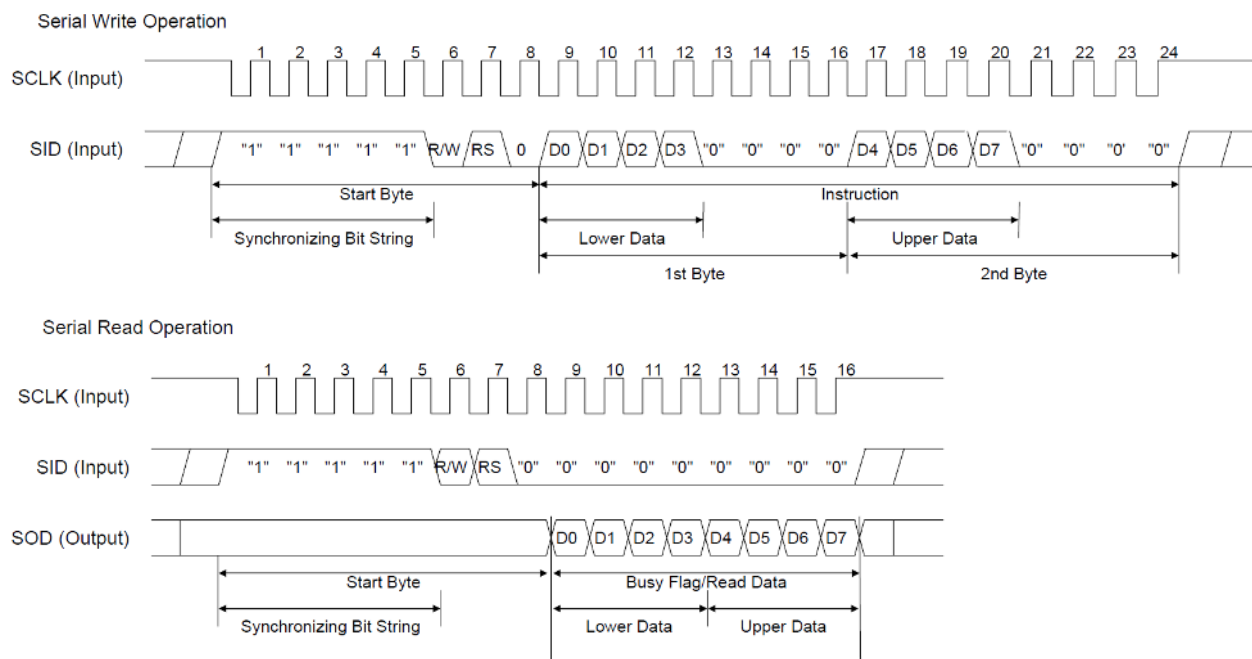

### I<sup>2</sup>C INTERFACE

The display can be assigned to the slave address 0x78 or 0x3C (SA0=VSS) and 0x7A or 0x3D (SA0=VDD). After transferring the start condition, the hardware address, together with the Read(1)/Write(0) bit has to be transmitted. While writing to the display, after the slave address, there always is a control byte holding the information Data(1) or Command(0) and the continuation bit. If the continuation bit is set to 0, the following bytes are data bytes until the next stop condition occurs. The maximum clock rate for I<sup>2</sup>C bus is 400 kHz.

Please be informed, that the pins SDA+SCK contain an internal resistance of 600 to 1000 Ohm, or even more (Important, because of the LO-level while reading data and the ACK-Bit).

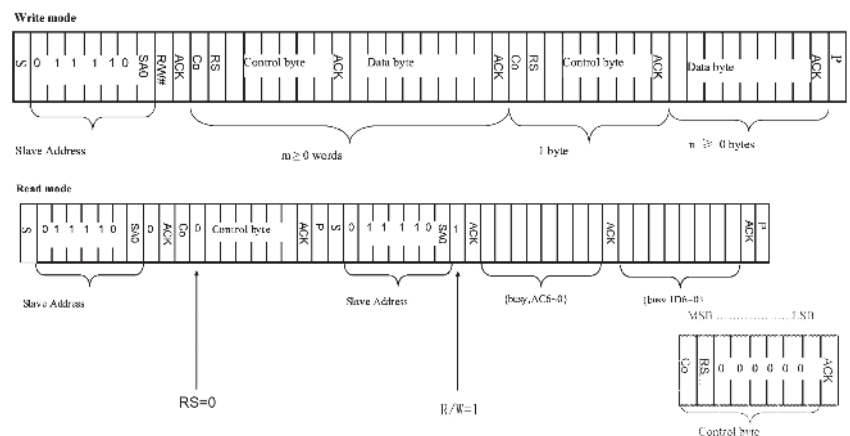

Further information about the interfaces and the timing of the SSD1803A, please refer to the datasheet [http://www.lcd-module.de/fileadmin/eng/pdf/zubehoer/ssd1803a\\_2\\_0.pdf](http://www.lcd-module.de/fileadmin/eng/pdf/zubehoer/ssd1803a_2_0.pdf)

**DIMENSIONS**

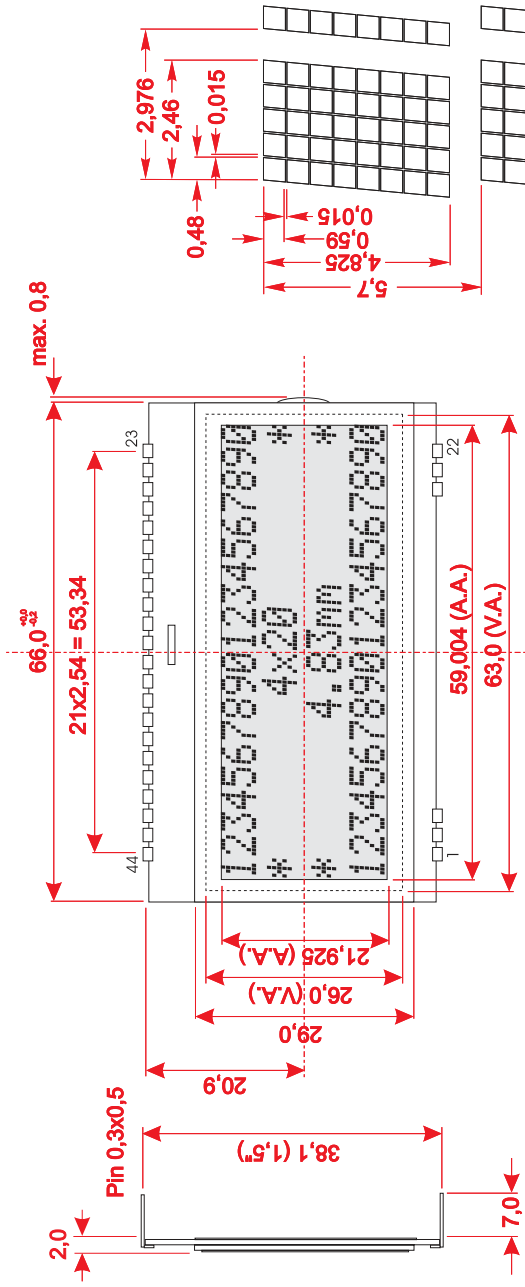

alle dimensions are in mm

**Note:**  
 - LC-displays are not suited for wave soldering or reflow soldering. Temperatures above +80°C may damage LCD module.  
 - Surfaces of display and backlight are equipped with protection foils to be protected against scratching. Please remove before use.

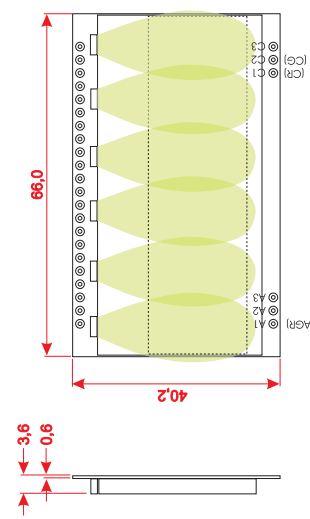
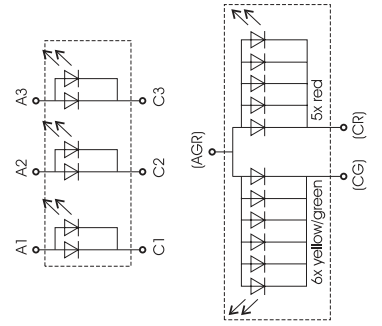

Note: The 6 LED pins A1, C1, A2, C2 (or AGR, CR, CR) must be soldered from the top to ensure a clean contact.

Pin	Symbol	Level	Function
1	NC		(A1+ : LED backlight)
2	NC		(A2+ : LED backlight)
3	NC		(A3+ : LED backlight)
4			
5	V2	-	Regulated voltage output
6	V4	-	Regulated voltage output
7	IM2	H/L	Interface mode select 2
8	IM1	H/L	Interface mode select 1
9	VDD	H	Power Supply +2.4, +3.6V
10	VSS	L	Power Supply 0V
11	D7	H/L	Data
12	D6	H/L	Data
13	D5	H/L	Data
14	D4	H/L	Data
15	D3	H/L	Data
16	D2	H/L	Data / SOD / SDAout
17	D1	H/L	Data / SID / SDAin
18	D0	H/L	Data / SCLK / SCL
19	E	H	Enable (falling edge)
20	NC		(C1- : LED backlight)
21	NC		(C2- : LED backlight)
22	NC		(C3- : LED backlight)
23	VOUT	-	Voltage converter output
24	V0	-	Regulated voltage output
25	V1	-	Regulated voltage output
26	V2	-	Regulated voltage output
27	V3	-	Regulated voltage output
28	V4	-	Regulated voltage output
29	IM2	H/L	Interface mode select 2
30	IM1	H/L	Interface mode select 1
31	VDD	H	Power Supply +2.4, +3.6V
32	VSS	L	Power Supply 0V
33	D7	H/L	Data
34	D6	H/L	Data
35	D5	H/L	Data
36	D4	H/L	Data
37	D3	H/L	Data
38	D2	H/L	Data / SOD / SDAout
39	D1	H/L	Data / SID / SDAin
40	D0	H/L	Data / SCLK / SCL
41	E	H	Enable (falling edge)
42	RW	H/L	L= Write, H=Read
43	RS	H/L	L= Ocmd, H=Data / SAO
44	RESET	L	Reset