

Ultra Low Phase Noise Amplifier

6 - 12 GHz



MAAL-011155

Rev. V3

Features

- Wideband Performance
- Phase Noise: -167 dBc/Hz @ 10 kHz Offset
- Noise Figure: 5 dB @ 6 GHz
- Bias Voltage: 5 V
- Bias Current: 90 mA
- 50 Ω Matched Input / Output
- Positive Voltage Only
- Lead-Free 4 mm 16-lead PQFN Package
- RoHS* Compliant

Applications

- Test & Measurement, EW, ECM, and Radar

Description

The MAAL-011155 is an easy to use, wideband ultra low phase noise distributed amplifier in a lead-free 4 mm 16-lead PQFN package. It operates from 6 to 12 GHz and provides -167 dBc/Hz phase noise, 15.6 dB of linear gain, 20 dBm of P1dB, and 5 dB of noise figure. The input and output are fully matched to 50 Ω with typical return loss of 16 dB.

The RF output port is DC blocked. Amplifier control is available through the use of a control circuit.

This product is fabricated using a low phase noise HBT process which features full passivation for enhanced reliability.

The MAAL-011155 can be used as a low noise amplifier stage for signal generation applications. This device is ideally suited for Test and Measurement, EW, ECM, and Radar applications where ultra low phase noise and drive power is required.

Functional Schematic

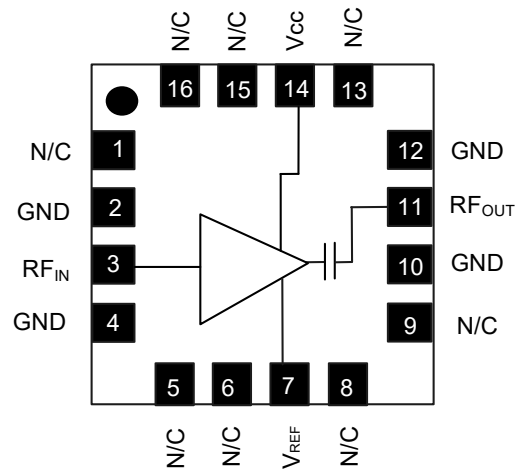

Pin Configuration

Pin #	Pin Name	Description
1,5,6,8,9,13,15,16	N/C ³	No Connection
2,4,10,12	GND	Ground
3	RF _{IN}	RF Input
7	V _{REF}	Reference Voltage
11	RF _{OUT}	RF Output
14	V _{CC}	Collector Voltage
Paddle ⁴	GND	Ground

3. MACOM recommends connecting unused package pins to ground.
4. The exposed pad centered on the package bottom must be connected to RF, DC and thermal ground.

Ordering Information^{1,2}

Part Number	Package
MAAL-011155-TR0100	100 piece reel
MAAL-011155-SMB	Sample Board

1. Reference Application Note M513 for reel size information.
2. All sample boards include 3 loose parts.

* Restrictions on Hazardous Substances, compliant to current RoHS EU directive.

Ultra Low Phase Noise Amplifier

6 - 12 GHz



MAAL-011155

Rev. V3

Electrical Specifications: Freq. = 6 - 12 GHz, $T_A = +25^\circ\text{C}$, $V_{CC} = +5\text{ V}$, $Z_0 = 50\ \Omega$

Parameter	Test Conditions	Units	Min.	Typ.	Max.
Gain	$P_{IN} = -15\text{ dBm}$ 6 GHz 9 GHz 12 GHz	dB	13.5 13.0 12.5	16.0 15.5 15.0	—
Gain Flatness	—	dB	—	± 0.4	—
Gain Variation over Temperature	—	dB/ $^\circ\text{C}$	—	0.017	—
Output Power	$P_{IN} = 5.0\text{ dBm}$, 6 GHz $P_{IN} = 4.7\text{ dBm}$, 9 GHz $P_{IN} = 3.0\text{ dBm}$, 12 GHz	dBm	17.0 17.0 14.5	20.0 20.0 17.5	—
Noise Figure	—	dB	—	5	—
Input Return Loss	—	dB	—	16	—
Output Return Loss	—	dB	—	16	—
P1dB	6 GHz	dBm	—	20	—
P3dB	6 GHz	dBm	—	23	—
OIP3	6 GHz, -10 dBm per tone	dBm	—	31.5	—
Phase Noise	6 GHz, P1dB 100 Hz 1 kHz 10 kHz 1 MKz	dBc/Hz	—	146 160 167 175	—
Icq	—	mA	—	90	—

Maximum Operating Conditions

Parameter	Maximum
P_{IN}	12 dBm
V_{CC}	6 V
Icq	105 mA
Junction Temperature ^{5,6}	+130 $^\circ\text{C}$
Operating Temperature	-40 $^\circ\text{C}$ to +85 $^\circ\text{C}$
Storage Temperature	-40 $^\circ\text{C}$ to +150 $^\circ\text{C}$

Absolute Maximum Ratings^{7,8}

Parameter	Absolute Maximum
Input Power	20 dBm
V_{CC}	6.5 V
Icq	170 mA
Junction Temperature ^{5,6}	+150 $^\circ\text{C}$
Operating Temperature	-40 $^\circ\text{C}$ to +85 $^\circ\text{C}$
Storage Temperature	-40 $^\circ\text{C}$ to +150 $^\circ\text{C}$

5. Operating at nominal conditions with $T_J \leq +150^\circ\text{C}$ will ensure $\text{MTTF} > 1 \times 10^6$ hours.
6. Junction Temperature (T_J) = $T_C + \Theta_{jc} * (V * I)$
Typical thermal resistance (Θ_{jc}) = 21.0 $^\circ\text{C}/\text{W}$.
 - a) For $T_C = +25^\circ\text{C}$,
 $T_J = 38.2^\circ\text{C}$ @ 6 V, 105 mA
 - b) For $T_C = +85^\circ\text{C}$,
 $T_J = 98.2^\circ\text{C}$ @ 6 V, 105 mA
7. Exceeding any one or combination of these limits may cause permanent damage to this device.
8. MACOM does not recommend sustained operation near these survivability limits.

PCB Layout

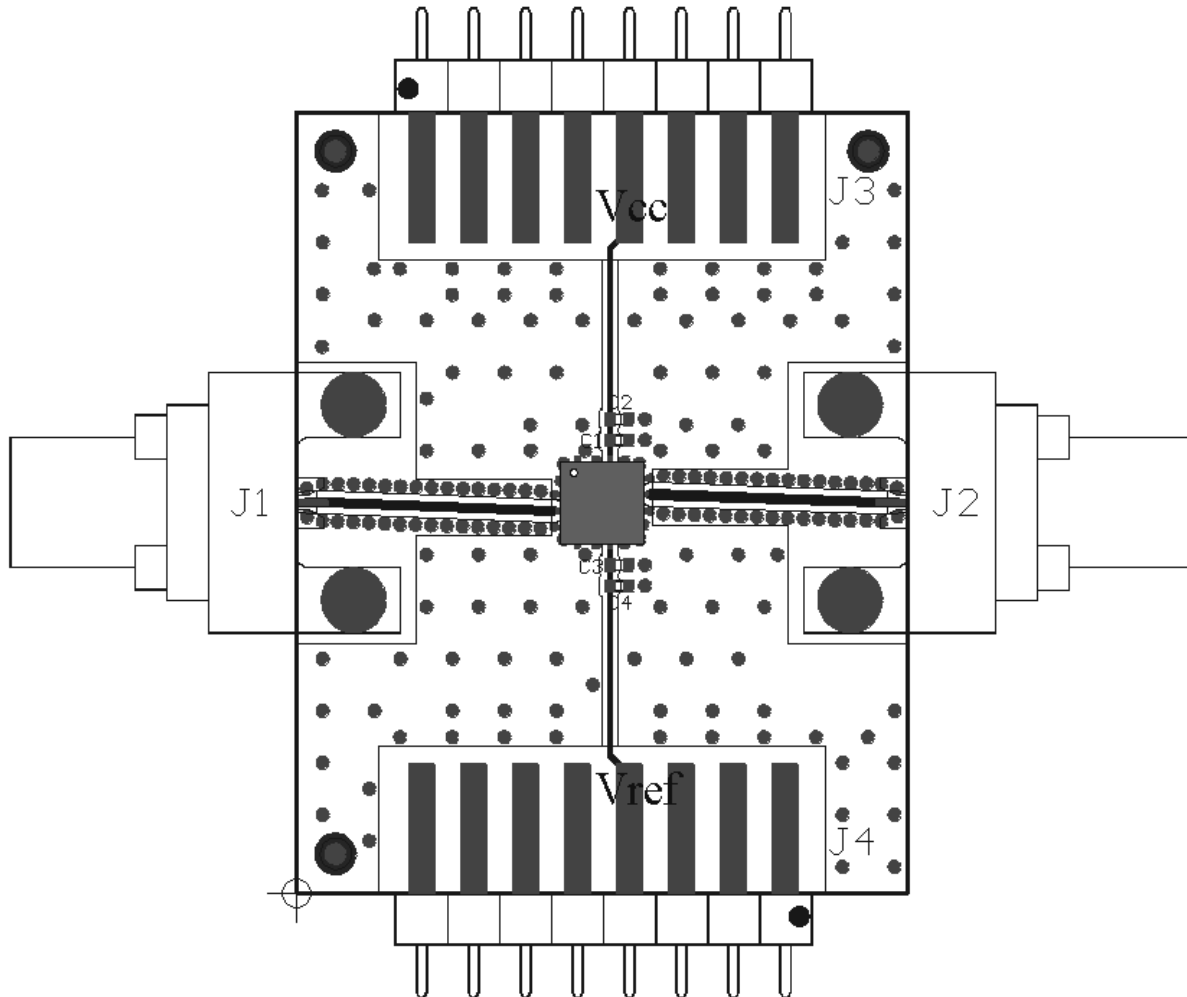

Parts List

Part	Value	Case Style
C1,C3	100 pF	0402
C2,C4	0.1 μ F	0402

Evaluation PCB Specifications

Top Layer: 1 oz Copper Cladding, 0.034 mm thickness
 Dielectric Layer: Rogers RO4350B 0.245 mm thickness
 Bottom Layer: 1 oz Copper Cladding, 0.034 mm thickness
 Finished overall thickness: 0.313 mm

Application Schematic

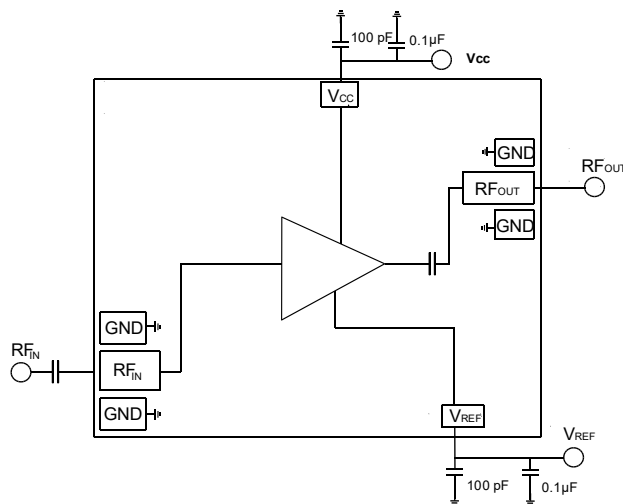

Operation

The technology is HBT; so, the turn-on and turn-off procedure is fairly simple.

To turn-on simply:

1. Apply +5 V to V_{CC}
2. Starting at 0 V, adjust V_{REF} for target I_{CC}

To turn-off:

1. Set V_{REF} to 0 V
2. Set V_{CC} to 0 V

Handling Procedures

Please observe the following precautions to avoid damage:

Static Sensitivity

These electronic devices are sensitive to electrostatic discharge (ESD) and can be damaged by static electricity. Proper ESD control techniques should be used when handling these HBM Class 1A devices.

Ultra Low Phase Noise Amplifier

6 - 12 GHz



MAAL-011155

Rev. V3

Typical Performance Curves: $V_{CC} = 5\text{ V}$, $I_{CC} = 90\text{ mA}$

Gain

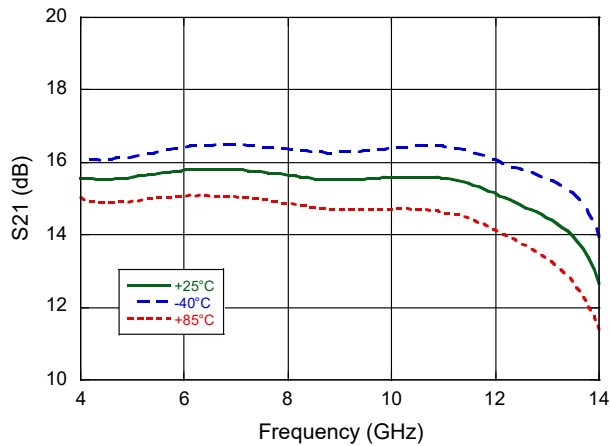

Noise Figure

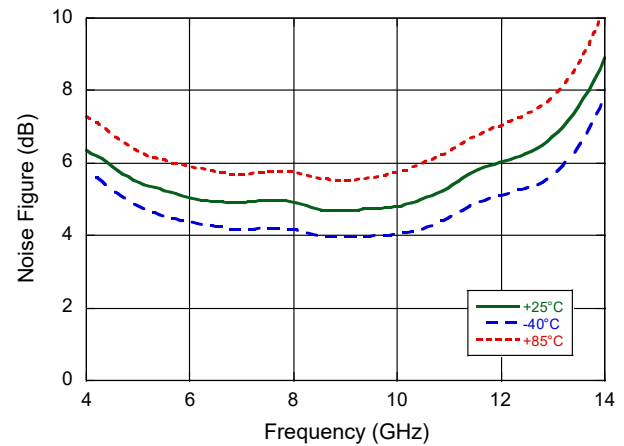

Input Return Loss

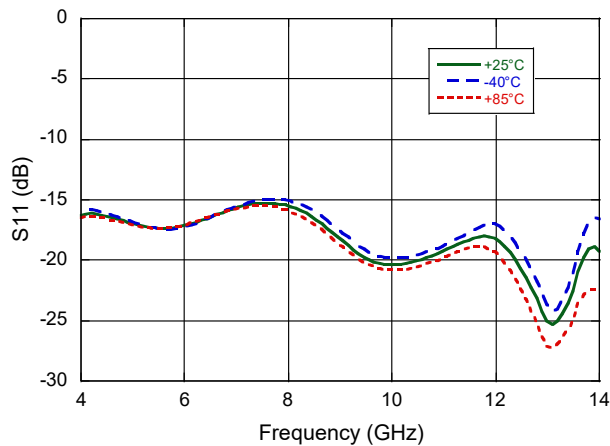

Output Return Loss

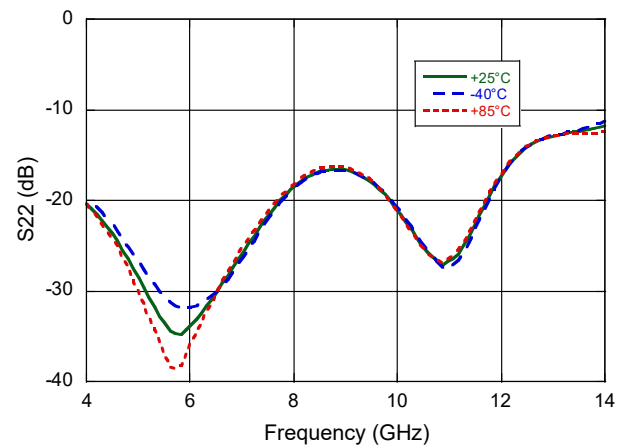

Reverse Isolation

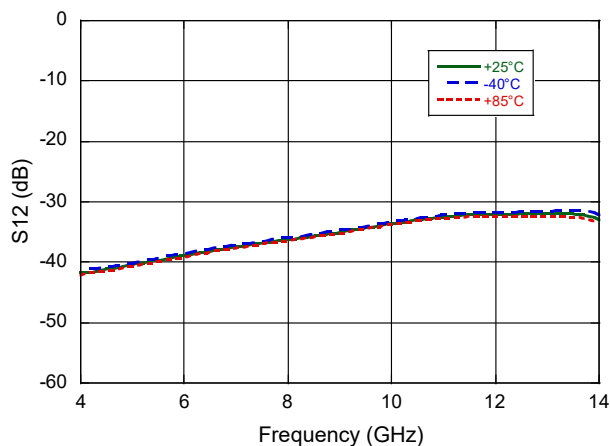

Output IP3
(10 MHz Tone Spacing, $P_{IN} = -10\text{ dBm}$ per tone)

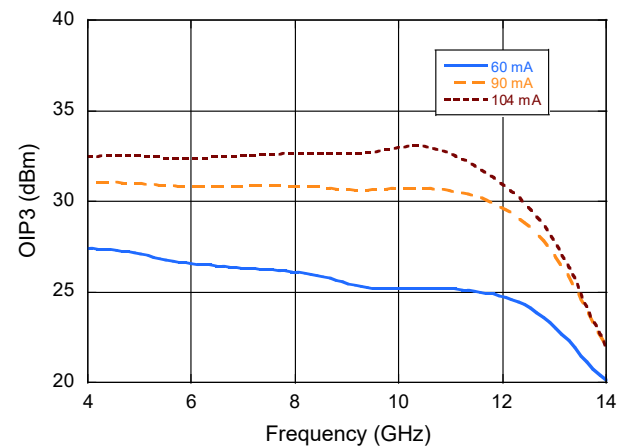

Ultra Low Phase Noise Amplifier

6 - 12 GHz



MAAL-011155

Rev. V3

Typical Performance Curves: $V_{CC} = 5\text{ V}$, $+25^\circ\text{C}$

Gain

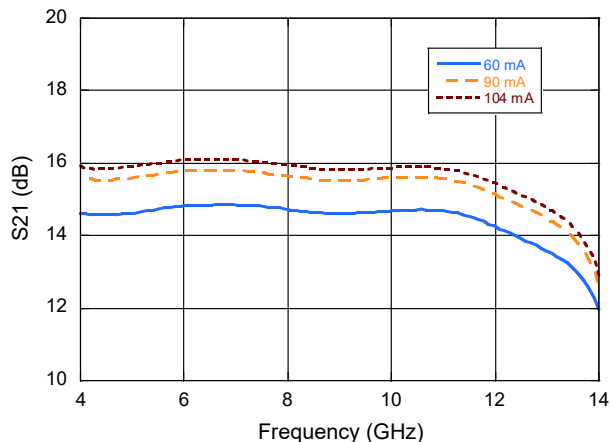

Input Return Loss

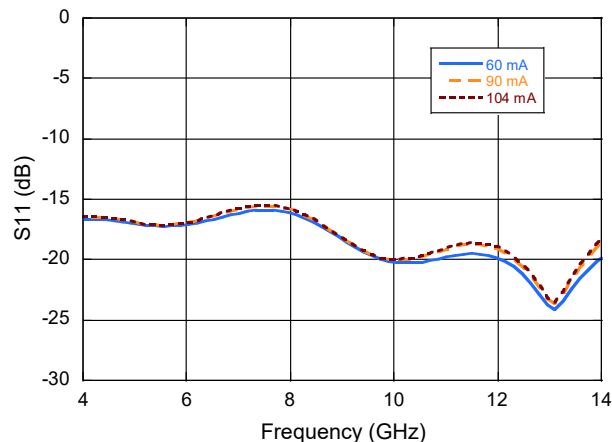

Output Return Loss

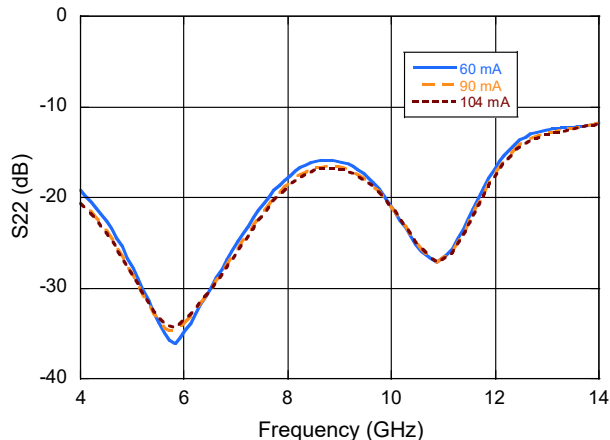

Reverse Isolation

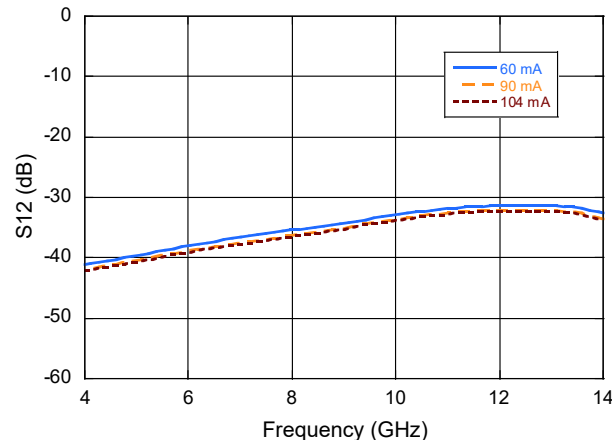

P1dB

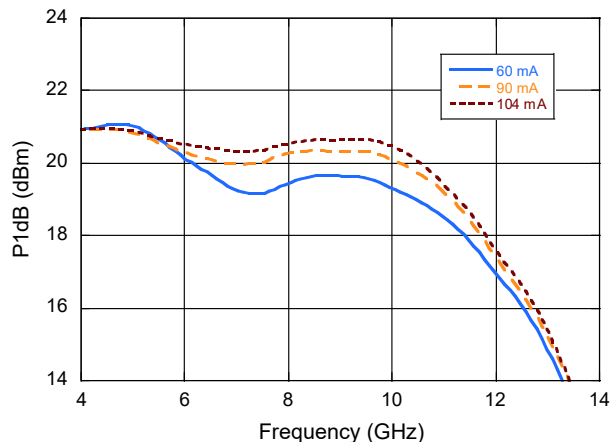

P_{SAT}

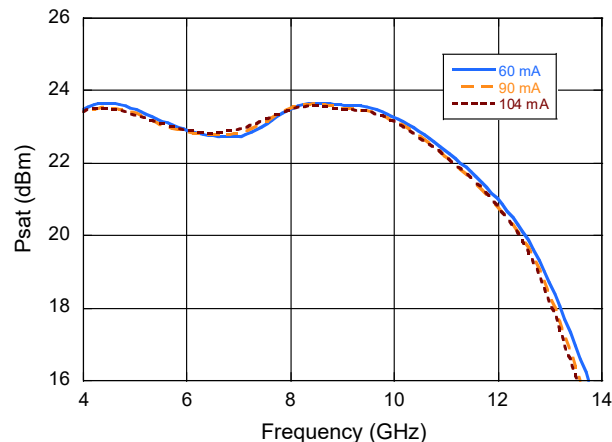

Ultra Low Phase Noise Amplifier 6 - 12 GHz



MAAL-011155

Rev. V3

Typical Performance Curves: $I_{CC} = 90 \text{ mA}$, $+25^\circ\text{C}$

Gain

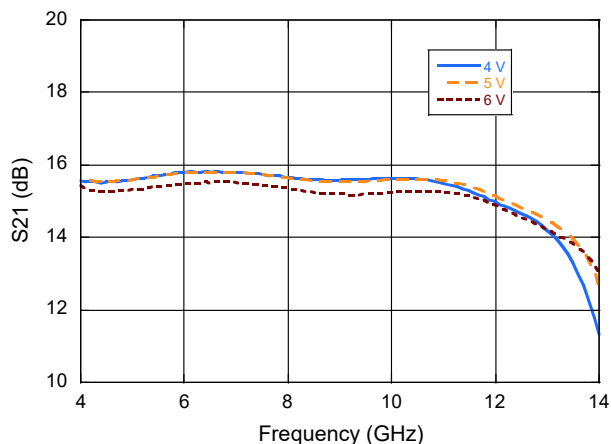

Input Return Loss

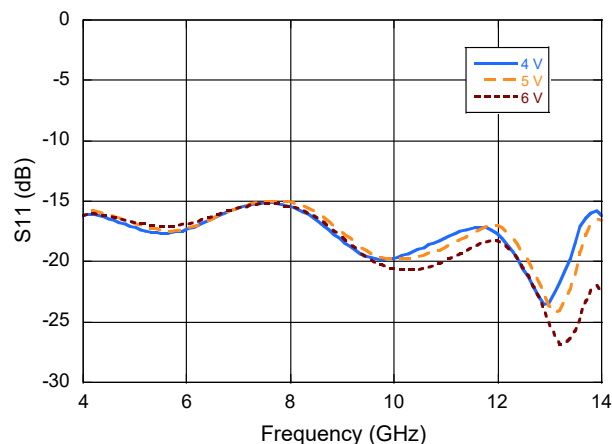

Output Return Loss

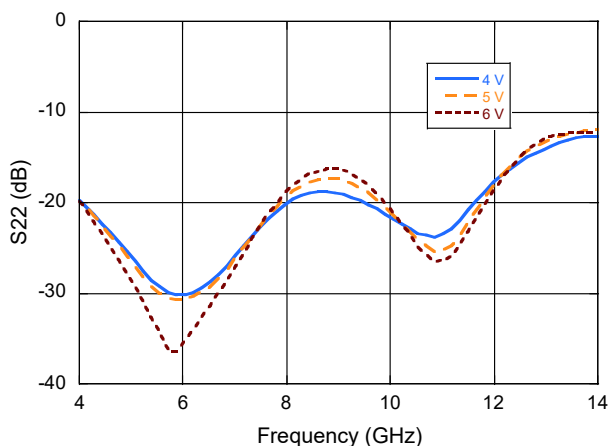

Reverse Isolation

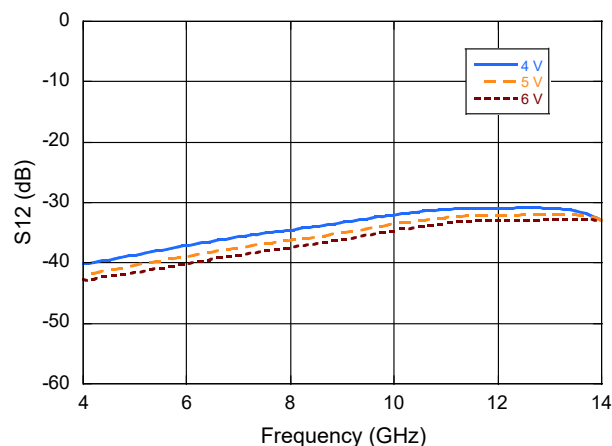

P1dB

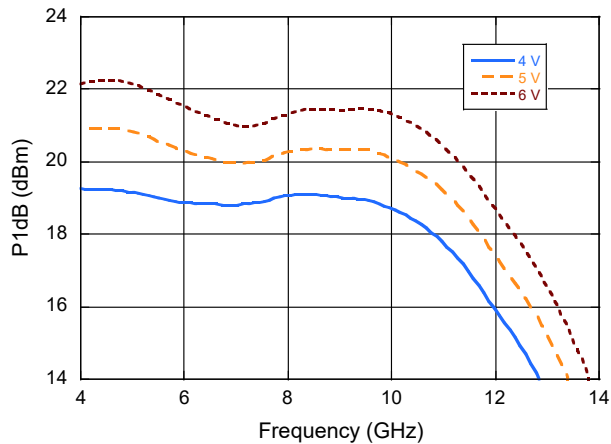

Psat

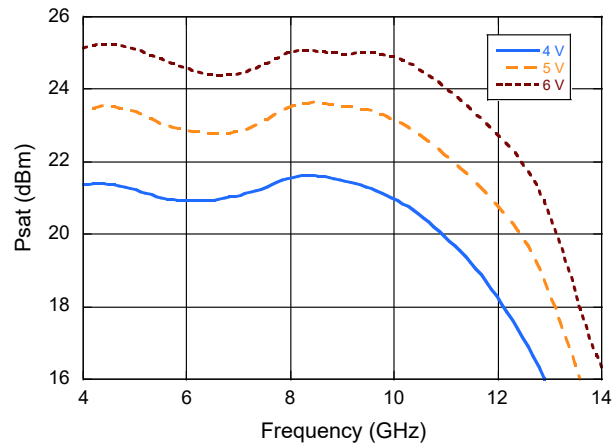

Ultra Low Phase Noise Amplifier 6 - 12 GHz



MAAL-011155

Rev. V3

Typical Performance Curves: $I_{CC} = 90 \text{ mA}$, $+25^\circ\text{C}$

Phase Noise @ 6 GHz, P1dB

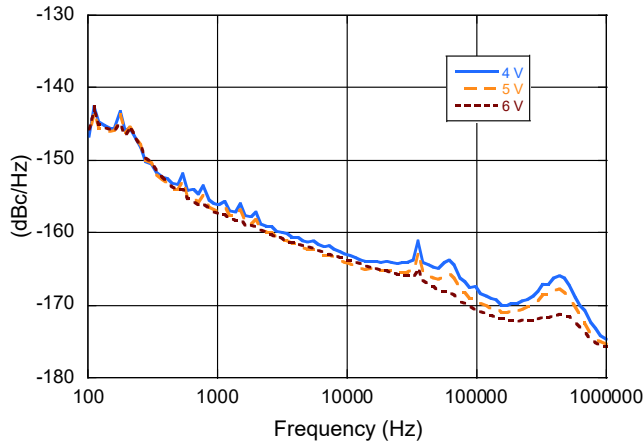

Phase Noise @ 6 GHz, P4dB

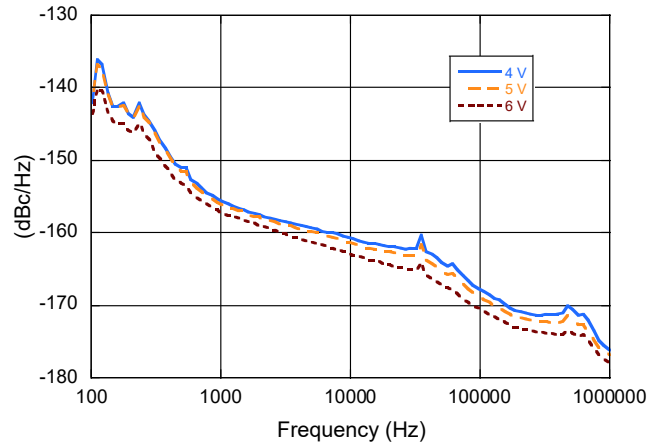

Phase Noise @ 9 GHz, P1dB

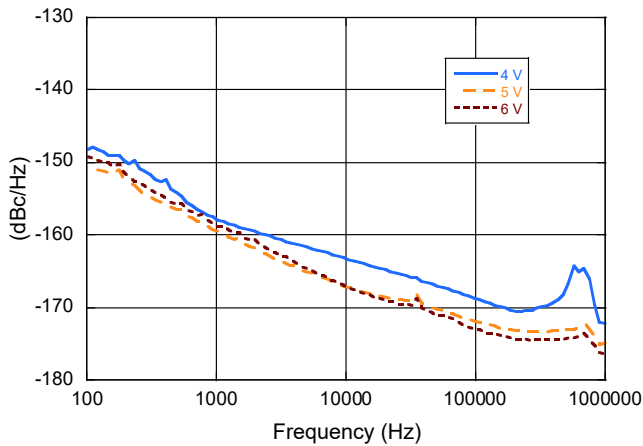

Phase Noise @ 9 GHz, P4dB

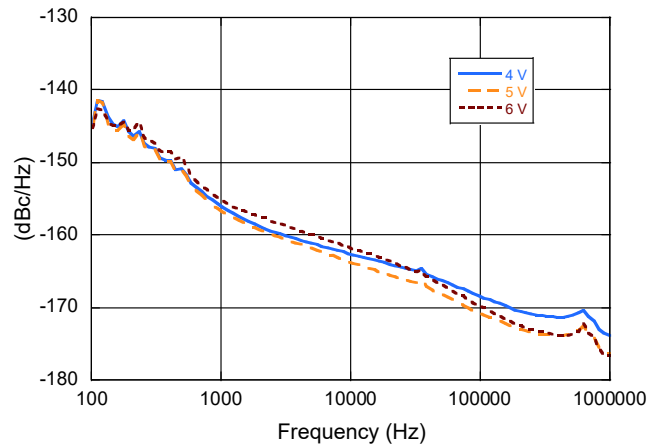

Phase Noise @ 12 GHz, P1dB

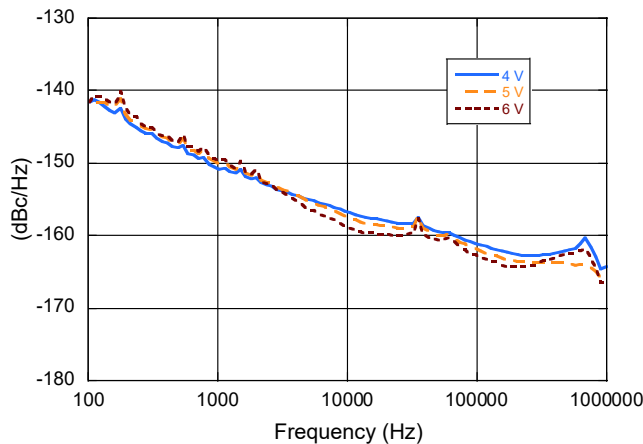

Phase Noise @ 12 GHz, P4dB

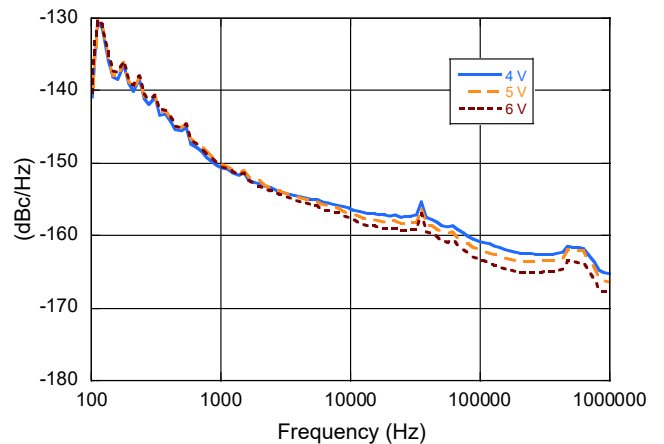

Ultra Low Phase Noise Amplifier 6 - 12 GHz



MAAL-011155

Rev. V3

Lead-Free 4 mm 16-Lead PQFN Package

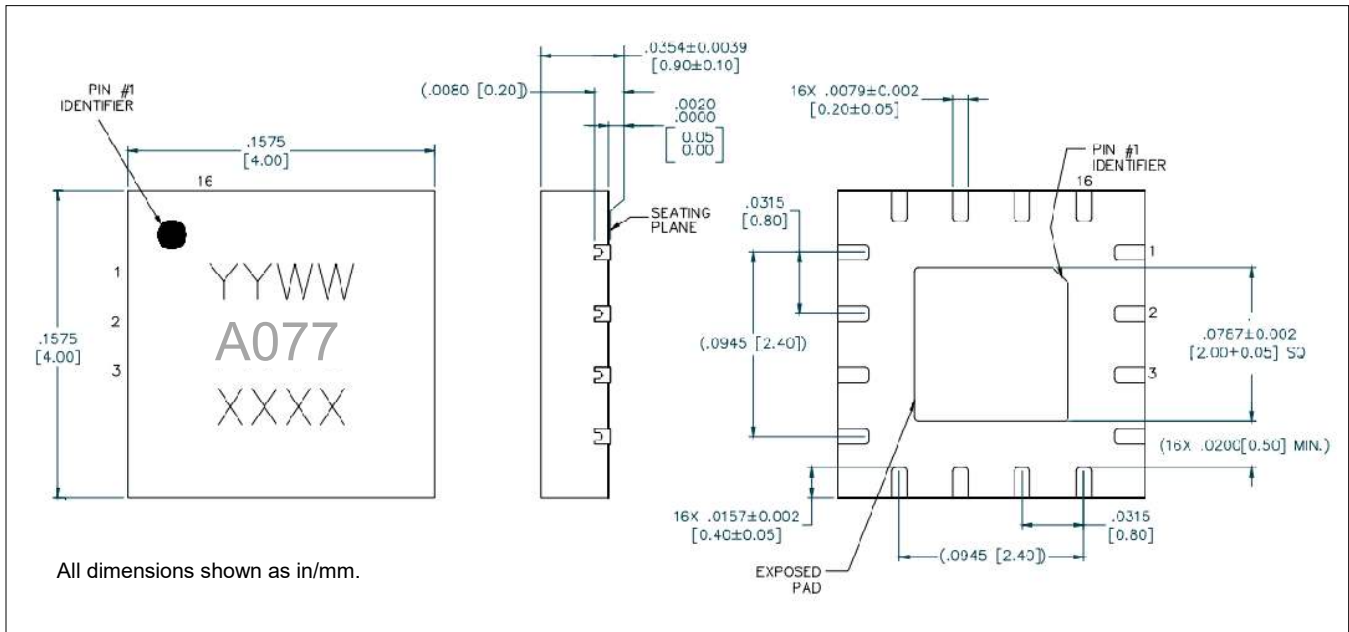

† Reference Application Note S2083 for lead-free solder reflow recommendations.
Meets JEDEC moisture sensitivity level 1 requirements.
Plating is NiPdAuAg.

Ultra Low Phase Noise Amplifier 6 - 12 GHz



MAAL-011155

Rev. V3

MACOM Technology Solutions Inc. ("MACOM"). All rights reserved.

These materials are provided in connection with MACOM's products as a service to its customers and may be used for informational purposes only. Except as provided in its Terms and Conditions of Sale or any separate agreement, MACOM assumes no liability or responsibility whatsoever, including for (i) errors or omissions in these materials; (ii) failure to update these materials; or (iii) conflicts or incompatibilities arising from future changes to specifications and product descriptions, which MACOM may make at any time, without notice. These materials grant no license, express or implied, to any intellectual property rights.

THESE MATERIALS ARE PROVIDED "AS IS" WITH NO WARRANTY OR LIABILITY, EXPRESS OR IMPLIED, RELATING TO SALE AND/OR USE OF MACOM PRODUCTS INCLUDING FITNESS FOR A PARTICULAR PURPOSE, MERCHANTABILITY, INFRINGEMENT OF INTELLECTUAL PROPERTY RIGHT, ACCURACY OR COMPLETENESS, OR SPECIAL, INDIRECT, INCIDENTAL, OR CONSEQUENTIAL DAMAGES WHICH MAY RESULT FROM USE OF THESE MATERIALS.

MACOM products are not intended for use in medical, lifesaving or life sustaining applications. MACOM customers using or selling MACOM products for use in such applications do so at their own risk and agree to fully indemnify MACOM for any damages resulting from such improper use or sale.