

344108-1 ✓ ACTIVE



Econoseal

TE Internal #: 344108-1

PCB Mount Header, Horizontal, Wire-to-Board, 36 Position, 5 mm [.197 in] Centerline, Fully Shrouded, Gold, Through Hole - Solder, Sealable, Econoseal

[View on TE.com >](#)

Connectors > PCB Connectors > PCB Headers & Receptacles > Low & Medium Power Header

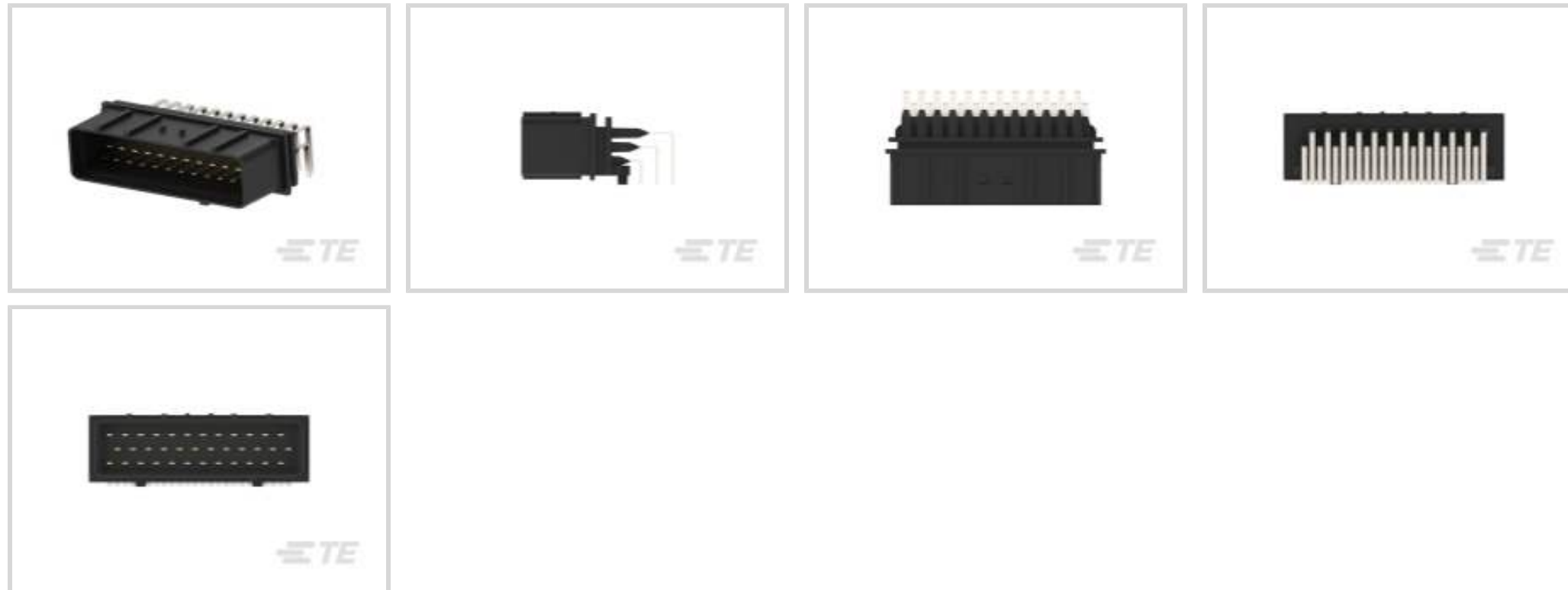

Connector System: **Wire-to-Board**

Number of Positions: **36**

Centerline (Pitch): **5 mm [.197 in]**

Sealable: **Yes**

PCB Mount Orientation: **Horizontal**

[All Low & Medium Power Header \(169\)](#)

Features

Product Type Features

Hybrid Header	No
Connector Shape	Rectangular
PCB Connector Assembly Type	PCB Mount Header
Header Type	Fully Shrouded
Connector System	Wire-to-Board
Sealable	Yes
Connector & Contact Terminates To	Printed Circuit Board

Configuration Features

Number of Sections	1
Number of Signal Positions	36
Number of Positions	36
PCB Mount Orientation	Horizontal
Number of Rows	3



Electrical Characteristics

Voltage Rating (Max)	12 VDC
----------------------	--------

Body Features

Primary Product Color	Black
-----------------------	-------

Contact Features

Contact Size	1.8mm
Contact Mating Area Plating Material	Gold

Termination Features

Termination Method to Printed Circuit Board	Through Hole - Solder
---	-----------------------

Mechanical Attachment

Mating Retention	With
Mating Alignment	With
PCB Mount Alignment	With
Panel Mount Feature	Without
PCB Mount Retention Type	Boardlock
Mating Retention Type	Locking Interface

Housing Features

Centerline (Pitch)	5 mm [.197 in]
--------------------	----------------

Dimensions

Connector Length	70.8 mm [2.787 in]
Connector Width	48.5 mm [1.909 in]
PCB Thickness (Recommended)	1.6 mm [.063 in]
Profile Height from PCB	27.15 mm [1.069 in]

Operation/Application

Shielded	No
----------	----

Industry Standards

UL Flammability Rating	None
------------------------	------

Packaging Features

Packaging Type	Tray
Packaging Quantity	117



Product Compliance

[For compliance documentation, visit the product page on TE.com>](#)

EU RoHS Directive 2011/65/EU	Compliant
EU ELV Directive 2000/53/EC	Compliant
China RoHS 2 Directive MIIT Order No 32, 2016	No Restricted Materials Above Threshold
EU REACH Regulation (EC) No. 1907/2006	Current ECHA Candidate List: JUNE 2023 (235) Candidate List Declared Against: JAN 2023 (233) Does not contain REACH SVHC
Halogen Content	BFR/CFR/PVC Free, but Br/Cl >900 ppm in other sources.
Solder Process Capability	Wave solder capable to 240°C

Product Compliance Disclaimer

This information is provided based on reasonable inquiry of our suppliers and represents our current actual knowledge based on the information they provided. This information is subject to change. The part numbers that TE has identified as EU RoHS compliant have a maximum concentration of 0.1% by weight in homogenous materials for lead, hexavalent chromium, mercury, PBB, PBDE, DBP, BBP, DEHP, DIBP, and 0.01% for cadmium, or qualify for an exemption to these limits as defined in the Annexes of Directive 2011/65/EU (RoHS2). Finished electrical and electronic equipment products will be CE marked as required by Directive 2011/65/EU. Components may not be CE marked. Additionally, the part numbers that TE has identified as EU ELV compliant have a maximum concentration of 0.1% by weight in homogenous materials for lead, hexavalent chromium, and mercury, and 0.01% for cadmium, or qualify for an exemption to these limits as defined in the Annexes of Directive 2000/53/EC (ELV). Regarding the REACH Regulation, the information TE provides on SVHC in articles for this part number is based on the latest European Chemicals Agency (ECHA) 'Guidance on requirements for substances in articles' posted at this URL: <https://echa.europa.eu/guidance-documents/guidance-on-reach>

Compatible Parts

 <p>TE Part # 344111-1 36W EMS.REC. HSG.ASSY</p>	<p>TE Part # 343934-3 HDR PIN - UPPER (LONG) COMB</p>	<p>TE Part # 343935-3 HDR PIN - MIDDLE (MEDIUM)COMB</p>	<p>TE Part # 343936-3 HDR PIN - LOWER (SHORT) COMB</p>
---	---	---	--

Also in the Series | Econoseal



Automotive Connector Caps & Covers (1)

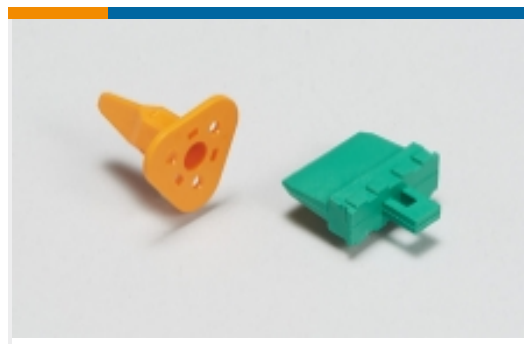

Automotive Connector Locks & Position Assurance(25)



Automotive Housings(105)

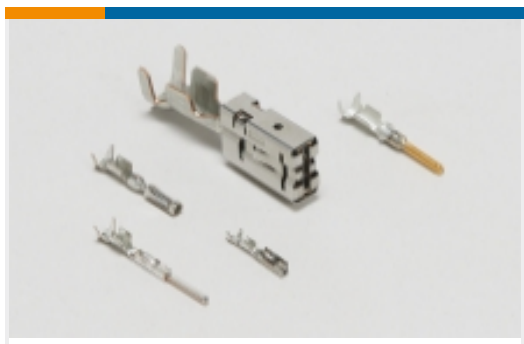

Automotive Terminals(48)



Connector Seals & Cavity Plugs(19)



Insertion & Extraction Tools(7)



Other Automotive Connector Accessories(5)

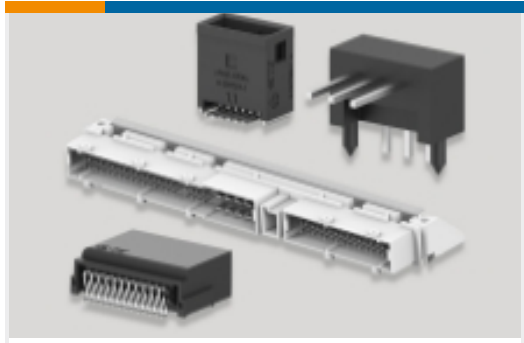

PCB Headers & Receptacles(4)

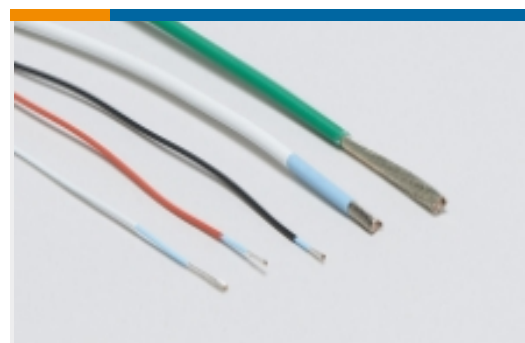

Primary Wire(1)

Customers Also Bought



TE Part #1-1969442-4
EP 2.5 TPA Housing, 14 Pos



TE Part #1721083-5
OJ-SS-109LMHF,000



TE Part #1-1969730-4
EP2.5 SHROUDED HDR ASSY 14P VERTICAL



TE Part #1744439-5
EP2.5 Shrd HDR ASSY 5P VERT, GW



TE Part #1-1744524-1
EP 11P HEADER ASY NO 6,10 PINS



TE Part #1-1969730-0
EP2.5 SHROUDED HDR ASSY 10P VERTICAL

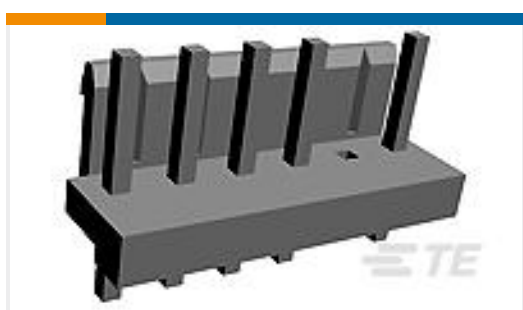

TE Part #6-1565036-5
EP CONN. HDR ASSY 5/6P W/O#5 BLUE



TE Part #8-1717011-4
EP CONN.HDR ASSY 4/5P BLACK (NO.3 POST)

Documents



Product Drawings

36 WAY HEADER WIRE TO BD.FOR E

English

CAD Files

3D PDF

English

Customer View Model

[ENG_CVM_344108-1_H.2d_dxf.zip](#)

English

Customer View Model

[ENG_CVM_344108-1_H.3d_igs.zip](#)

English

Customer View Model

[ENG_CVM_344108-1_H.3d_stp.zip](#)

English

By downloading the CAD file I accept and agree to the [Terms and Conditions](#) of use.