

DG406, DG407

Single 16-Channel/Differential 8-Channel, CMOS Analog Multiplexers

August 1997

Features

- **ON-Resistance (Max)**.....100Ω
- **Low Power Consumption (P_D)** <1.2mW
- **Fast Transition Time (Max)** 300ns
- **Low Charge Injection**
- **TTL, CMOS Compatible**
- **Single or Split Supply Operation**

Applications

- **Battery Operated Systems**
- **Data Acquisition**
- **Medical Instrumentation**
- **Hi-Rel Systems**
- **Communication Systems**
- **Automatic Test Equipment**

Ordering Information

| PART NUMBER | TEMP. RANGE (°C) | PACKAGE | PKG. NO. |
|----------------|------------------|------------|----------|
| DG406DJ | -40 to 85 | 28 Ld PDIP | E28.6 |
| DG406DY | -40 to 85 | 28 Ld SOIC | M28.3 |
| DG406EJ (Note) | -40 to 85 | 28 Ld PDIP | E28.6 |
| DG406EY (Note) | -40 to 85 | 28 Ld SOIC | M28.3 |
| DG406DN | -40 to 85 | 28 Ld PLCC | N28.45 |
| DG407DJ | -40 to 85 | 28 Ld PDIP | E28.6 |
| DG407DY | -40 to 85 | 28 Ld SOIC | M28.3 |
| DG407EJ (Note) | -40 to 85 | 28 Ld PDIP | E28.6 |
| DG407EY (Note) | -40 to 85 | 28 Ld SOIC | M28.3 |
| DG407DN | -40 to 85 | 28 Ld PLCC | N28.45 |

NOTE: Extended Processing Flow

Description

The DG406 and DG407 monolithic CMOS analog multiplexers are drop-in replacements for the popular DG506A and DG507A series devices. They each include an array of sixteen analog switches, a TTL and CMOS compatible digital decode circuit for channel selection, a voltage reference for logic thresholds, and an ENABLE input for device selection when several multiplexers are present.

These multiplexers feature lower signal ON resistance (<100Ω) and faster transition time ($t_{TRANS} < 300ns$) compared to the DG506A and DG507A. Charge injection has been reduced, simplifying sample and hold applications.

The improvements in the DG406 series are made possible by using a high voltage silicon-gate process. An epitaxial layer prevents the latch-up associated with older CMOS technologies. The 44V maximum voltage range permits controlling 30V_{p-p} signals when operating with ±15V power supplies.

The sixteen switches are bilateral, equally matched for AC or bidirectional signals. The ON resistance variation with analog signals is quite low over a ±5V analog input range.

DG406, DG407

Pinouts

DG406 (PDIP, SOIC)
TOP VIEW

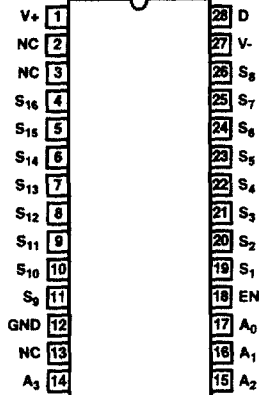

DG406 (PLCC)
TOP VIEW

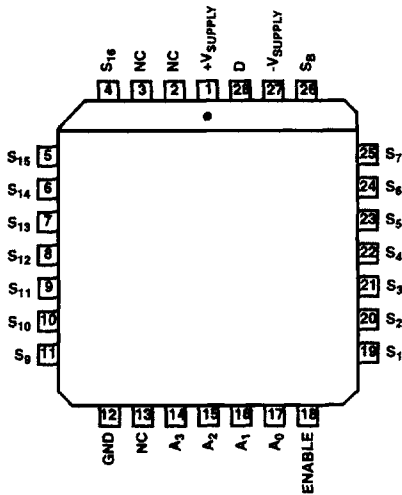

DG407 (PDIP, SOIC)
TOP VIEW

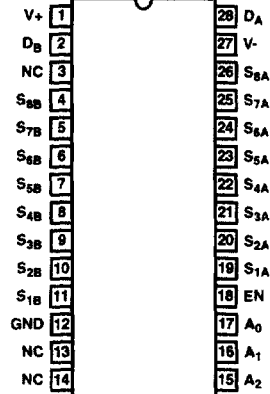

DG407 (PLCC)
TOP VIEW

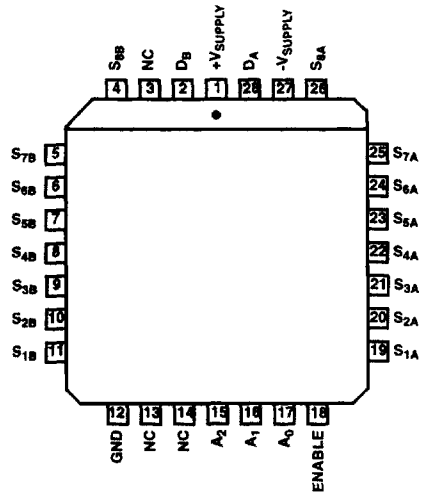

Functional Block Diagrams

DG406

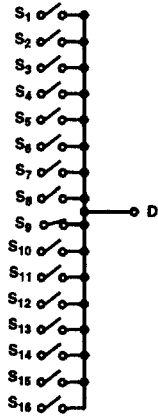

TO DECODER LOGIC
CONTROLLING BOTH
TIERS OF MUXING

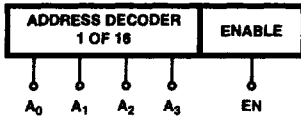

DG406 TRUTH TABLE

| A ₃ | A ₂ | A ₁ | A ₀ | EN | ON SWITCH |
|----------------|----------------|----------------|----------------|----|-----------|
| X | X | X | X | 0 | None |
| 0 | 0 | 0 | 0 | 1 | 1 |
| 0 | 0 | 0 | 1 | 1 | 2 |
| 0 | 0 | 1 | 0 | 1 | 3 |
| 0 | 0 | 1 | 1 | 1 | 4 |
| 0 | 1 | 0 | 0 | 1 | 5 |
| 0 | 1 | 0 | 1 | 1 | 6 |
| 0 | 1 | 1 | 0 | 1 | 7 |
| 0 | 1 | 1 | 1 | 1 | 8 |
| 1 | 0 | 0 | 0 | 1 | 9 |
| 1 | 0 | 0 | 1 | 1 | 10 |
| 1 | 0 | 1 | 0 | 1 | 11 |
| 1 | 0 | 1 | 1 | 1 | 12 |
| 1 | 1 | 0 | 0 | 1 | 13 |
| 1 | 1 | 0 | 1 | 1 | 14 |
| 1 | 1 | 1 | 0 | 1 | 15 |
| 1 | 1 | 1 | 1 | 1 | 16 |

DG407

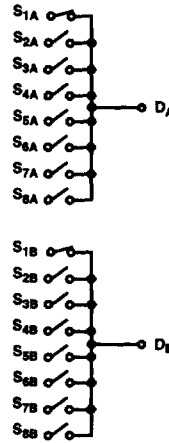

TO DECODER LOGIC
CONTROLLING BOTH
TIERS OF MUXING

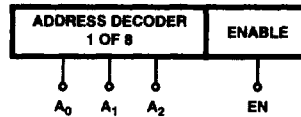

DG407 TRUTH TABLE

| A ₂ | A ₁ | A ₀ | EN | ON SWITCH PAIR |
|----------------|----------------|----------------|----|----------------|
| X | X | X | 0 | None |
| 0 | 0 | 0 | 1 | 1 |
| 0 | 0 | 1 | 1 | 2 |
| 0 | 1 | 0 | 1 | 3 |
| 0 | 1 | 1 | 1 | 4 |
| 1 | 0 | 0 | 1 | 5 |
| 1 | 0 | 1 | 1 | 6 |
| 1 | 1 | 0 | 1 | 7 |
| 1 | 1 | 1 | 1 | 8 |

Logic "0" = V_{AL} < 0.8V
Logic "1" = V_{AH} > 2.4V
X = Don't Care

DG406, DG407

Absolute Maximum Ratings

| | |
|--|---|
| Voltages Referenced to V- | |
| V+ | +44.0V |
| GND | 25V |
| Digital Inputs, V _S , V _D (Note 1) | (V-) -2V to (V+) +2V or 20mA, Whichever Occurs First |
| Current (Any Terminal) | 30mA |
| Peak Current, S or D | 100mA |
| (Pulsed 1ms, 10% Duty Cycle Max) | |

Thermal Information

| | |
|--|----------------------|
| Thermal Resistance (Typical, Note 2) | θ_{JA} (°C/W) |
| PDIP Package | 60 |
| SOIC Package | 75 |
| PLCC Package | 65 |
| Maximum Junction Temperature | 150°C |
| Maximum Storage Temperature Range | -65°C to 150°C |
| Maximum Lead Temperature (Soldering 10s) | 300°C |
| (PLCC and SOIC - Lead Tips Only) | |

Operating Conditions

Temperature Range -40°C to 85°C

CAUTION: Stresses above those listed in "Absolute Maximum Ratings" may cause permanent damage to the device. This is a stress only rating and operation of the device at these or any other conditions above those indicated in the operational sections of this specification is not implied.

NOTES:

1. Signals on S_X, D_X or IN_X exceeding V+ or V- will be clamped by internal diodes. Limit forward diode current to maximum current ratings.
2. θ_{JA} is measured with the component mounted on an evaluation PC board in free air.

Electrical Specifications Test Conditions: V+ = +15V, V- = -15V, V_{AL} = 0.8V, V_{AH} = 2.4V Unless Otherwise Specified

| PARAMETER | TEST CONDITIONS | (NOTE 3) TEMP | D SUFFIX 40°C TO 85°C | | | UNITS | |
|---|---|------------------|-----------------------|-----------------|-----------------|-------|----|
| | | | (NOTE 4) MIN | (NOTE 5) TYP | (NOTE 4) MAX | | |
| ANALOG SWITCH | | | | | | | |
| Drain-Source ON Resistance, r _{DS(ON)} | V _D = ±10V, I _S = ±10mA (Note 6) | Room | - | 50 | 100 | Ω | |
| | | Full | - | - | 125 | Ω | |
| r _{DS(ON)} Matching Between Channels, Δr _{DS(ON)} | V _D = 10V, -10V (Note 7) | Room | - | 5 | - | % | |
| Source OFF Leakage Current, I _{S(OFF)} | V _{EN} = 0V, V _S = ±10V, V _D = ±10V | Room | -0.5 | 0.01 | 0.5 | nA | |
| | | Full | -5 | - | 5 | nA | |
| Drain OFF Leakage Current, I _{D(OFF)} | | DG406 | Room | -1 | 0.04 | 1 | nA |
| | | | Full | -40 | - | 40 | nA |
| | | DG407 | Room | -1 | 0.04 | 1 | nA |
| | | | Full | -20 | - | 20 | nA |
| Drain ON Leakage Current, I _{D(ON)} | V _S = V _D = ±10V (Note 6) | DG406 | Room | -1 | 0.04 | 1 | nA |
| | | | Full | -40 | - | 40 | nA |
| | | DG407 | Room | -1 | 0.04 | 1 | nA |
| | | | Full | -20 | - | 20 | nA |
| DIGITAL CONTROL | | | | | | | |
| Logic High Input Voltage, V _{INH} | | Full | 2.4 | - | - | V | |
| Logic Low Input Voltage, V _{INL} | | Full | - | - | 0.8 | V | |
| Logic High Input Current, I _{AH} | V _A = 2.4V, 15V | Full | -1 | - | 1 | μA | |
| Logic Low Input Current, I _{AL} | V _{EN} = 0V, 2.4V, V _A = 0V | Full | -1 | - | 1 | μA | |
| Logic Input Capacitance, C _{IN} | f = 1MHz | Room | - | 7 | - | pF | |

DG406, DG407

Electrical Specifications Test Conditions: $V_+ = +15V$, $V_- = -15V$, $V_{AL} = 0.8V$, $V_{AH} = 2.4V$ Unless Otherwise Specified (Continued)

| PARAMETER | TEST CONDITIONS | (NOTE 3) TEMP | D SUFFIX 40°C TO 85°C | | | UNITS |
|--|---|------------------|-----------------------|-----------------|-----------------|---------|
| | | | (NOTE 4) MIN | (NOTE 5) TYP | (NOTE 4) MAX | |
| DYNAMIC CHARACTERISTICS | | | | | | |
| Transition Time, t_{TRANS} | (See Figure 1) | Room | - | 200 | 300 | ns |
| | | Full | - | - | 400 | ns |
| Break-Before-Make Interval, t_{OPEN} | (See Figure 3) | Room | 25 | 50 | - | ns |
| | | Full | 10 | - | - | ns |
| Enable Turn-ON Time, $t_{ON(EN)}$ | (See Figure 2) | Room | - | 150 | 200 | ns |
| | | Full | - | - | 400 | ns |
| Enable Turn-OFF Time, $t_{OFF(EN)}$ | | Room | - | 70 | 150 | ns |
| | | Full | - | - | 300 | ns |
| Charge Injection, Q | $C_L = 1nF$, $V_S = 0V$, $R_S = 0\Omega$ | Room | - | 40 | - | pC |
| OFF Isolation, OIRR | $V_{EN} = 0V$, $R_L = 1k\Omega$, $f = 100kHz$ (Note 8) | Room | - | -69 | - | dB |
| Source OFF Capacitance, $C_{S(OFF)}$ | $V_{EN} = 0V$, $V_S = 0V$, $f = 1MHz$ | Room | - | 8 | - | pF |
| Drain OFF Capacitance, $C_{D(OFF)}$ | $V_{EN} = 0V$, $V_D = 0V$, $f = 1MHz$ | Room | - | 160 | - | pF |
| | | DG406 | | | | |
| DG407 | Room | - | 80 | - | pF | |
| Drain ON Capacitance, $C_{D(ON)}$ | $V_{EN} = 5V$, $V_D = 0V$, $f = 1MHz$ | Room | - | 180 | - | pF |
| | | DG406 | | | | |
| DG407 | Room | - | 90 | - | pF | |
| POWER SUPPLIES | | | | | | |
| Positive Supply Current, I_+ | $V_{EN} = V_A = 0V$ or 5V Stand By | Room | - | 13 | 30 | μA |
| | | Full | - | - | 75 | μA |
| Negative Supply Current, I_- | | Room | -1 | -0.01 | - | μA |
| | | Full | -10 | - | - | μA |
| Positive Supply Current, I_+ | $V_{EN} = 2.4V$, $V_A = 0V$ | Room | - | -0.01 | 100 | μA |
| | | Full | - | - | 200 | μA |
| Negative Supply Current, I_- | | Room | -1 | - | - | μA |
| | | Full | -10 | - | - | μA |

Electrical Specifications (Single Supply) Test Conditions: $V_+ = 12V$, $V_- = 0V$, $V_{AL} = 0.8V$, $V_{AH} = 2.4V$. Unless Otherwise Specified

| PARAMETER | TEST CONDITIONS | (NOTE 3) TEMP | D SUFFIX -40°C TO 85°C | | | UNITS |
|--|--|------------------|------------------------|-----------------|-----------------|-------|
| | | | (NOTE 4) MIN | (NOTE 5) TYP | (NOTE 4) MAX | |
| DYNAMIC CHARACTERISTICS | | | | | | |
| Switching Time of Multiplexer, t_{TRANS} | $V_{S1} = 8V$, $V_{S8} = 0V$, $V_{IN} = 2.4V$ | Room | - | 300 | 450 | ns |

DG406, DG407

Electrical Specifications (Single Supply) Test Conditions: $V_+ = 12V$, $V_- = 0V$, $V_{AL} = 0.8V$, $V_{AH} = 2.4V$, Unless Otherwise Specified (Continued)

| PARAMETER | TEST CONDITIONS | (NOTE 3) TEMP | D SUFFIX -40°C TO 85°C | | | UNITS |
|--|--|---------------|------------------------|--------------|--------------|----------|
| | | | (NOTE 4) MIN | (NOTE 5) TYP | (NOTE 4) MAX | |
| Enable Turn-ON Time, $T_{ON(EN)}$ | $V_{INH} = 2.4V$, $V_{INL} = 0V$, $V_{S1} = 5V$ | Room | - | 250 | 600 | ns |
| Enable Turn-OFF Time, $T_{OFF(EN)}$ | | Room | - | 150 | 300 | ns |
| Charge Injection, Q | $C_L = 1nF$, $V_S = 6V$, $R_S = 0\Omega$ | Room | - | 20 | - | pC |
| ANALOG SWITCH | | | | | | |
| Analog Signal Range, V_{ANALOG} | | Full | 0 | - | 12 | V |
| Drain-Source ON-Resistance, $r_{DS(ON)}$ | $V_D = 3V, 10V$, $I_S = -1mA$ (Note 6) | Room | - | 90 | 120 | Ω |
| $r_{DS(ON)}$ Matching Between Channels (Note 7), $\Delta r_{DS(ON)}$ | | Room | - | 5 | - | % |
| Source Off Leakage Current, $I_{S(OFF)}$ | $V_{EN} = 0V$, $V_D = 10V$ or $0.5V$, $V_S = 0.5V$ or $10V$ | Room | - | 0.01 | - | nA |
| Drain Off Leakage Current, $I_{D(OFF)}$ DG406 | | Room | - | 0.04 | - | nA |
| DG407 | | Room | - | 0.04 | - | nA |
| Drain On Leakage Current, $I_{D(ON)}$ DG406 | $V_S = V_D = \pm 10V$ (Note 6) | Room | - | 0.04 | - | nA |
| DG407 | | Room | - | 0.04 | - | nA |
| POWER SUPPLIES | | | | | | |
| Positive Supply Current (I_+) | $V_{EN} = 0V$ or $5V$, $V_A = 0V$ or $5V$ | Room | - | 13 | 30 | μA |
| | | Full | - | 13 | 75 | μA |
| Negative Supply Current (I_-) | | Room | -1 | -0.01 | - | μA |
| | | Full | -5 | -0.01 | - | μA |

NOTES:

3. Room = 25°C, Cold and Hot = as determined by the operating temperature suffix.
4. The algebraic convention whereby the most negative value is a minimum and the most positive a maximum, is used in this data sheet.
5. Typical values are for Design Aid Only, not guaranteed nor production tested.
6. Sequence each switch ON.
7. $\Delta r_{DS(ON)} = r_{DS(ON)} (\text{Max}) - r_{DS(ON)} (\text{Min}) + r_{DS} \text{ average}$
8. Worst case isolation occurs on channel 8B due to proximity to the drain pin.

Test Circuits and Waveforms

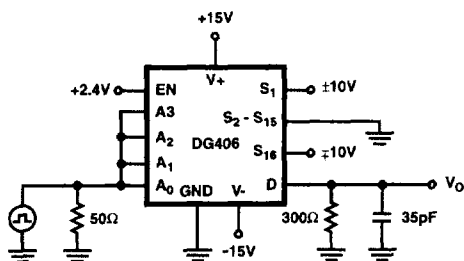

FIGURE 1A.

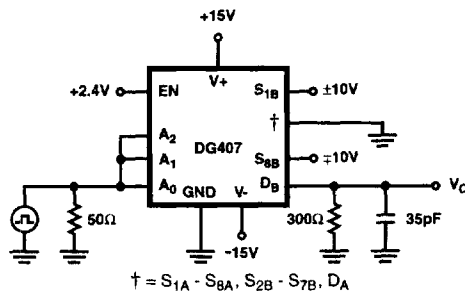

FIGURE 1B.

Test Circuits and Waveforms (Continued)

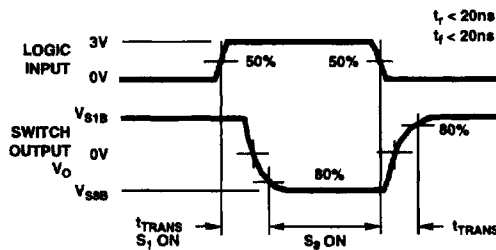

FIGURE 1C.

FIGURE 1. TRANSITION TIME

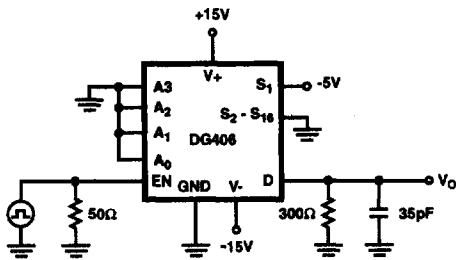

FIGURE 2A.

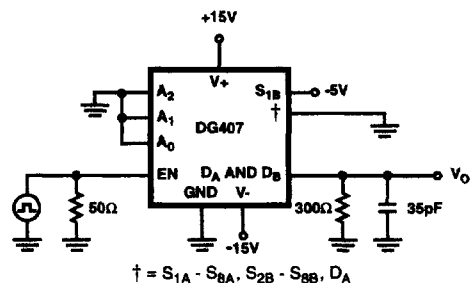

FIGURE 2B.

$$t = S_{1A} \cdot S_{8A} \cdot S_{2B} \cdot S_{8B} \cdot D_A$$

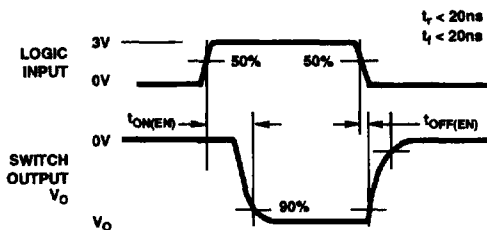

FIGURE 2C.

FIGURE 2. ENABLE SWITCHING TIME

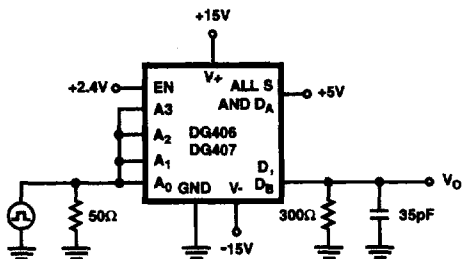

FIGURE 3A.

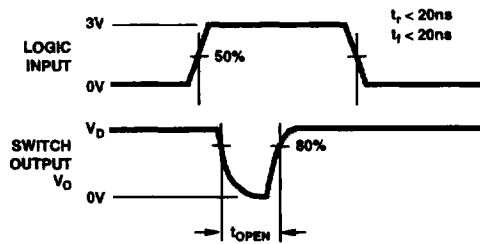

FIGURE 3B.

FIGURE 3. BREAK-BEFORE-MAKE INTERVAL

DG406, DG407

Burn-In Circuit

CERDIP/SOIC BURN-IN SCHEMATIC

DG406/407EY/EJ

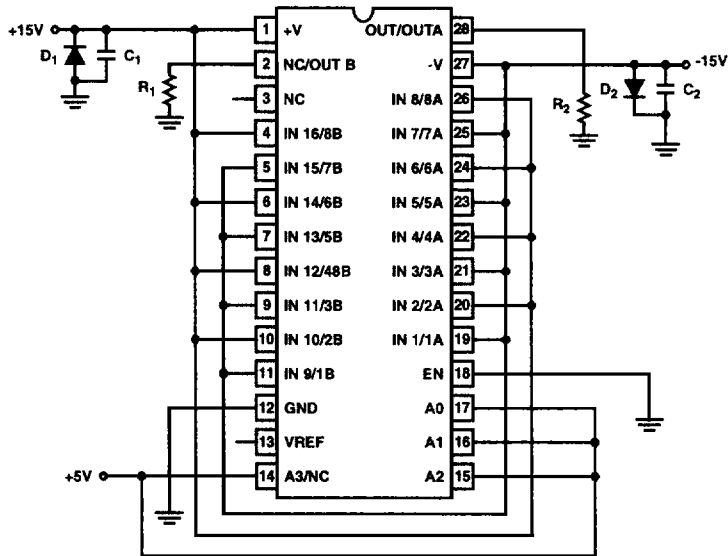

NOTE:

R₁, R₂ = 10kΩ ±5%, 1/2W or 1/4W (Per Socket)
 C₁, C₂ = 0.01μF (Min, Per Socket) or 0.1μF (Min, Per Row)
 D₁, D₂ = IN402 (or Equivalent, Per Board)

Schematic Diagram (Typical Channel)

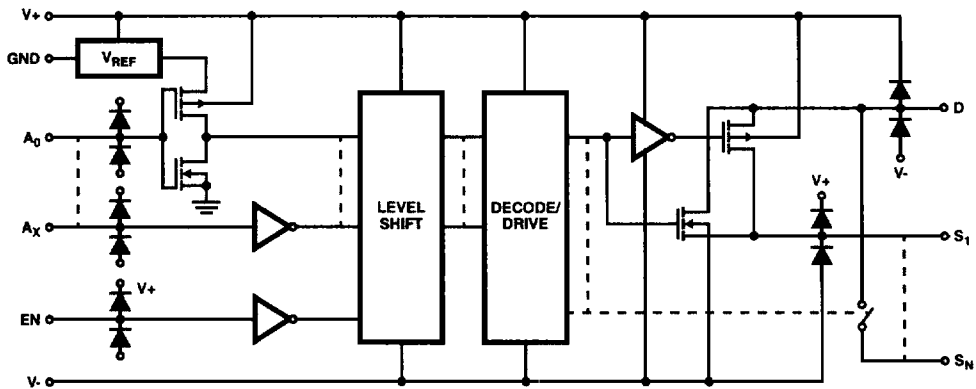

Typical Performance Curves

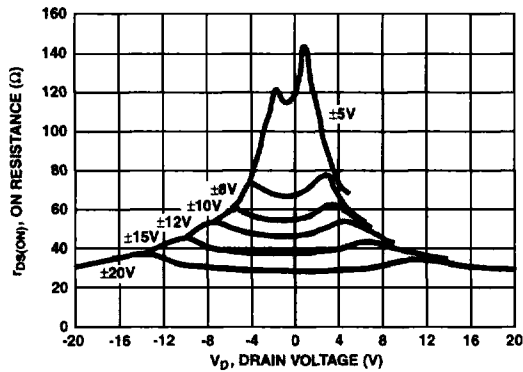

FIGURE 4. $r_{DS(ON)}$ vs V_D AND SUPPLY

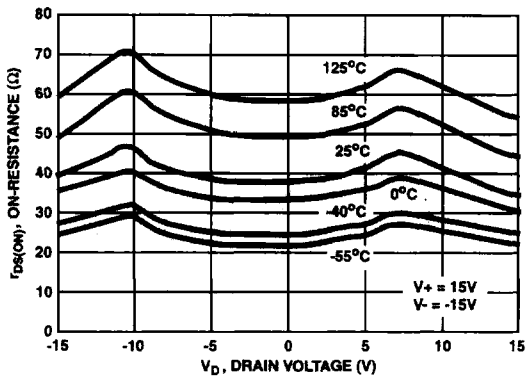

FIGURE 5. $r_{DS(ON)}$ vs V_D AND TEMPERATURE

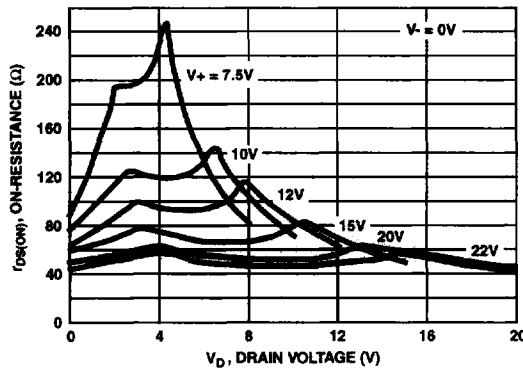

FIGURE 6. $r_{DS(ON)}$ vs V_D AND SUPPLY

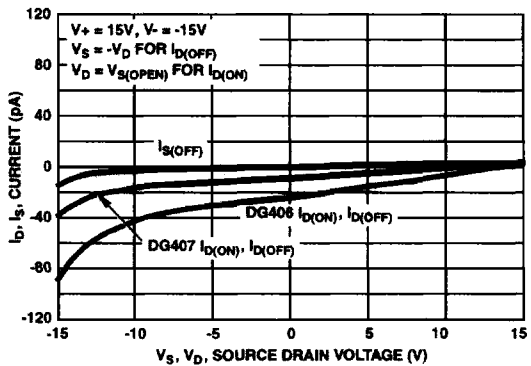

FIGURE 7. I_D, I_S LEAKAGE CURRENTS vs ANALOG VOLTAGE

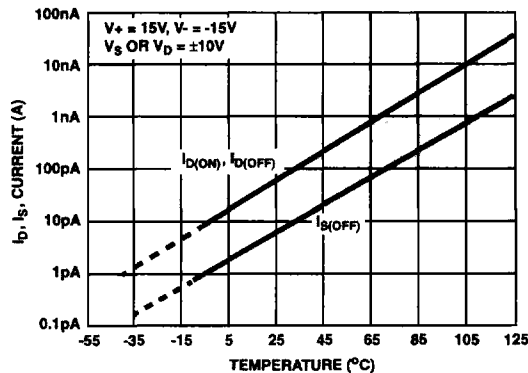

FIGURE 8. I_D, I_S LEAKAGE vs TEMPERATURE

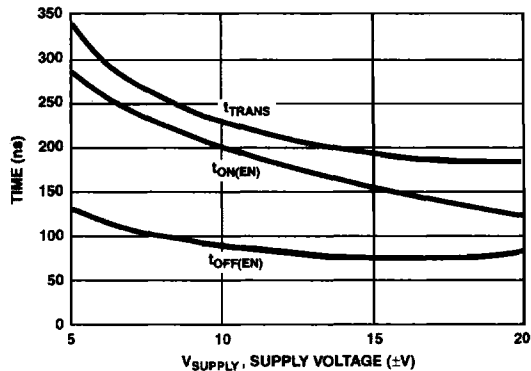

FIGURE 9. SWITCHING TIMES vs BIPOLAR SUPPLIES

Typical Performance Curves (Continued)

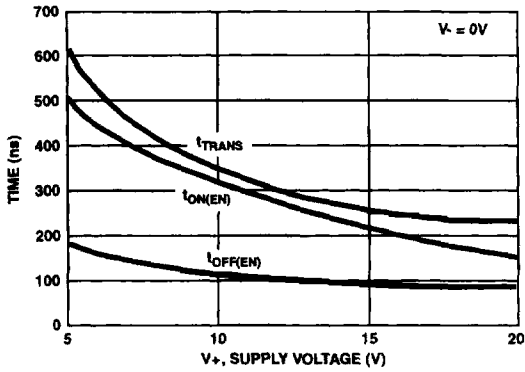

FIGURE 10. SWITCHING TIMES vs SINGLE SUPPLY

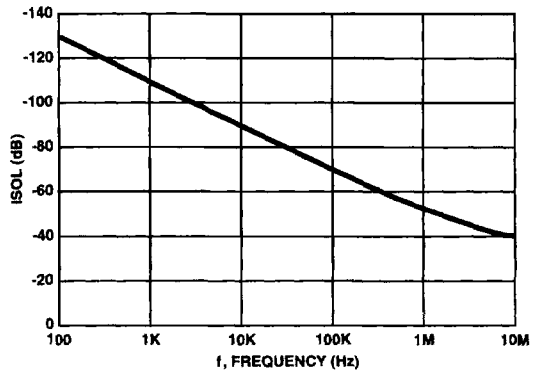

FIGURE 11. OFF-ISOLATION vs FREQUENCY

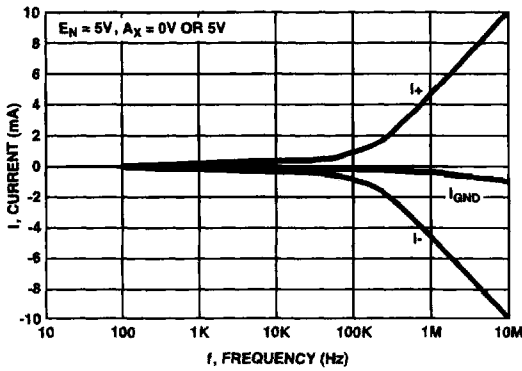

FIGURE 12. SUPPLY CURRENTS vs SWITCHING FREQUENCY

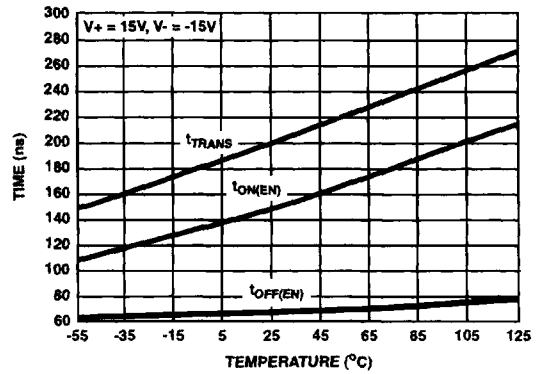

FIGURE 13. t_{ON}/t_{OFF} vs TEMPERATURE

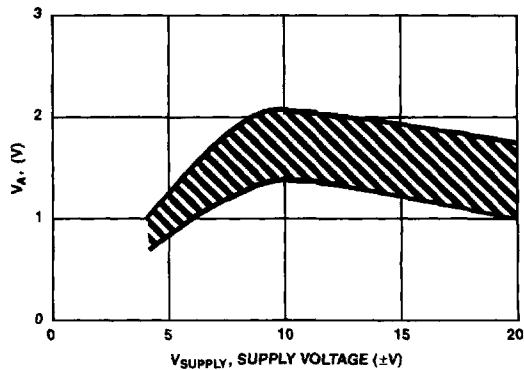

FIGURE 14. SWITCHING THRESHOLD vs SUPPLY VOLTAGE

DG406, DG407

Die Characteristics

DIE DIMENSIONS:

2490 μ m x 4560 μ m x 485 μ m \pm 25 μ m

METALLIZATION:

Type: SiAl
Thickness: 12k \AA \pm 1k \AA

PASSIVATION:

Type: Nitride
Thickness: 8k \AA \pm 1k \AA

WORST CASE CURRENT DENSITY:

9.1 x 10⁴ A/cm²

Metallization Mask Layout

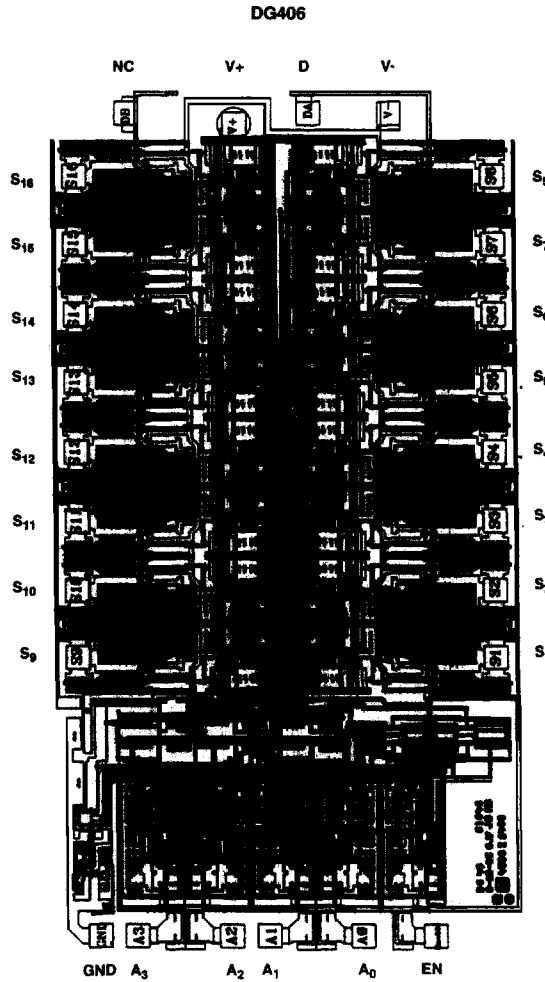

DG406, DG407

Die Characteristics

DIE DIMENSIONS:

2490 μm x 4560 μm x 485 μm \pm 25 μm

METALLIZATION:

Type: SiAl
Thickness: 12k \AA \pm 1k \AA

PASSIVATION:

Type: Nitride
Thickness: 8k \AA \pm 1k \AA

WORST CASE CURRENT DENSITY:

9.1 x 10⁴ A/cm²

Metallization Mask Layout

DG407

