

TPS55330EVM-017 2.9-V to 4.2-V Input, 5.0-V Output Boost Evaluation Module

This user's guide contains information for the TPS55330EVM-017 evaluation module (EVM) as well as the TPS55330 DC/DC converter. The document includes the performance specifications, schematic, and the bill of materials for the TPS55330EVM-017.

Contents

1	Background	2
2	Performance Specification Summary	2
3	Modifications	2
4	Test Setup and Results	3
5	Board Layout	11
6	Schematic and Bill of Materials	14

List of Figures

1	TPS55330EVM-017 Efficiency	4
2	TPS55330EVM-017 Output Voltage Load Regulation	4
3	TPS55330EVM-017 Output Voltage Line Regulation	5
4	TPS55330EVM-017 $V_{IN} = 3.6\text{-V}$ Transient Response	5
5	TPS55330EVM-017 Loop Response	6
6	TPS55330EVM-017 $V_{IN} = 3.6\text{-V}$ Output Ripple	6
7	TPS55330EVM-017 DCM Output Ripple	7
8	TPS55330EVM-017 $V_{IN} = 3.6\text{-V}$ Pulse-Skipping	7
9	TPS55330EVM-017 $V_{IN} = 5\text{-V}$ Input Voltage Ripple	8
10	TPS55330EVM-017 $V_{IN} = 3.6\text{-V}$ Input Voltage Ripple	8
11	TPS55330EVM-017 Power Up With EN	9
12	TPS55330EVM-017 Power Down With EN	9
13	TPS55330EVM-017 Power Up With V_{IN}	10
14	TPS55330EVM-017 Power Down With V_{IN}	10
15	TPS55330EVM-017 Top-Side Assembly	11
16	TPS55330EVM-017 Top-Side Layout	12
17	TPS55330EVM-017 Internal Layer-1 Layout	12
18	TPS55330EVM-017 Internal Layer-2 Layout	13
19	TPS55330EVM-017 Bottom-Side Layout	13
20	TPS55330EVM-017 Schematic	14

List of Tables

1	Input Voltage and Output Current Summary	2
2	Performance Specification Summary	2
3	EVM Connectors and Test Points	3
4	TPS55330EVM-017 Bill of Materials	15

1 Background

The TPS55330 DC/DC converter is a step-up boost converter. Rated input voltage and output current range for the evaluation module are given in [Table 1](#). This EVM demonstrates the performance of the TPS55330 in an example application and accommodates evaluation of other boost applications supported by the TPS55330. This design shows that a small printed-circuit-board area is possible when designing with the TPS55330 regulator. However, appropriate sizing of the inductor and diode for the desired application can further reduce the board area. The switching frequency is externally set at a nominal 600 kHz. The 24-V, 5-A, low-side MOSFET is incorporated inside the TPS55330 package along with the gate-drive circuitry. The low drain-to-source on-resistance of the MOSFET achieves high efficiencies with the TPS55330. The compensation components are external to the integrated circuit (IC). The absolute maximum input voltage is 18 V for the EVM.

Table 1. Input Voltage and Output Current Summary

EVM	Input Voltage Range	Maximum Output Current
TPS55330EVM-017	$V_{IN} = 2.9 \text{ V to } 4.2 \text{ V}$	$I_{OUTmax} = 2.1 \text{ A}$

2 Performance Specification Summary

[Table 2](#) provides a summary of the EVM performance specifications. Specifications are given for an input voltage of $V_{IN} = 3.6 \text{ V}$ with an output voltage of 5 V, unless otherwise specified. The ambient temperature is 25°C for all measurements, unless otherwise noted.

Table 2. Performance Specification Summary

Specification	Test Conditions		Min	Typ	Max	Unit
V_{IN} voltage range			2.9	3.6	4.2	V
Output voltage set point			5			V
Line regulation	$I_{OUT} = 2.1 \text{ A}, V_{IN} = 2.9 \text{ V to } 4.2 \text{ V}$		±0.1%			
Operating frequency			600			kHz
Output current range			0.001	2.1		A
Load regulation	$I_{OUT} = 1 \text{ mA to } 2.1 \text{ A}$		±0.1%			
Load transient response	$I_{OUT} = 525 \text{ mA to } 1.575 \text{ A}$	Voltage change	-220			mV
		Recovery time	400			µs
	$I_{OUT} = 1.575 \text{ A to } 525 \text{ mA}$	Voltage change	180			mV
		Recovery time	400			µs
Loop bandwidth	$I_{OUT} = 2.1 \text{ A}$		10			kHz
Phase margin	$I_{OUT} = 2.1 \text{ A}$		76			°
Output ripple voltage	$I_{OUT} = 2.1 \text{ A}$		20			mVpp
Maximum efficiency	TPS55330EVM-017, $V_{IN} = 4.2 \text{ V}, I_{OUT} = 700 \text{ mA}$		92.5%			

3 Modifications

These evaluation modules provide access to the features of the TPS55330. Some modifications to this module are possible.

3.1 Output Voltage Set Point

The resistor divider network of R1 and R2 sets the output voltage. Keep R2 fixed at or close to 10 kΩ. Change the output voltage of the EVM by changing the value of resistor R1. Calculate the value of R1 for a specific output voltage by using [Equation 1](#).

$$R1 = R2 \times \left(\frac{V_{OUT}}{1.229V} - 1 \right) \quad (1)$$

Note that V_{IN} must be in a range so that the on-time is greater than the minimum controllable on-time (77 ns typical), and the maximum duty cycle is less than 89% minimum and 93% typical.

3.2 Maximum Output Current

After adjusting input or output voltage settings, verify the maximum output current pursuant to the equations given on the data sheet ([SLVSBX8](#)).

3.3 Slow-Start Time

Adjust the slow-start time by changing the value of C3. The EVM uses $C3 = 0.047 \mu\text{F}$, as recommended on the data sheet, avoiding any overshoot during start-up. A larger capacitance increases the slow-start time while a smaller capacitance decreases it.

3.4 Other Modifications

Please see data sheet recommendations and equations when changing the switching frequency, input/output voltage range, input inductor, output capacitors or compensation.

4 Test Setup and Results

This section describes how to properly connect, set up, and use the EVM. Included are test results typical for the evaluation module covering efficiency, output voltage regulation, load transients, loop response, output ripple, input ripple, start-up and shut-down.

4.1 Input/Output Connections

The EVM is provided with input and output connectors and test points as shown in [Table 3](#). Connect a power supply capable of supplying 5 A to J6 through a pair of 20-AWG wires. The jumper across JP1 in the ON position (1-2) must be in place. Connect the load to J7 through a pair of 20-AWG wires. The maximum load-current capability must be at least 2.1 A. Minimize wire lengths to reduce losses in the wires. Header J1 provides a place to monitor the V_{IN} input voltages with J3 providing a convenient ground reference. Use J2 to monitor the output voltage with J4 as the ground reference.

Table 3. EVM Connectors and Test Points

Reference Designator	Function
J1	2-pin header for V_{IN} input voltage connections
J2	2-pin header for V_{OUT} input voltage connections
J3, J4	2-pin header for GND connections
J5	2-pin header for synchronizing signal and ground
J6	V_{IN} input voltage connector. (See Table 1 for V_{IN} range.)
JP1	3-pin header for enable. Jumper installed from pins 1-2 enables and from pins 2-3 disables.
TP1	SW test point
TP2	Test point between voltage divider network and output. Used for loop-response measurements.
TP3	COMP test point
TP4	Output voltage test point at V_{OUT} connector
TP5	GND test point at V_{OUT} connector

4.2 Efficiency

The efficiency of this EVM peaks at a load current of about 400 mA at 2.9-V input and 700 mA at 4.2-V input, then decreases as the load current increases toward full load. Figure 1 shows the efficiency for the EVM at an ambient temperature of 25°C.

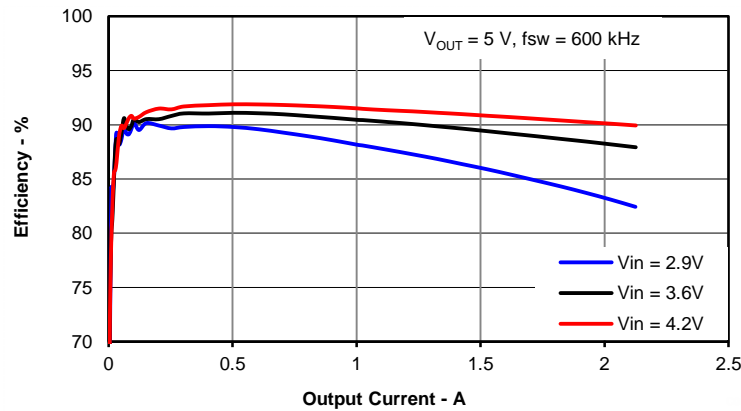

Figure 1. TPS55330EVM-017 Efficiency

The efficiency may be lower at higher ambient temperatures, due to temperature variation in the drain-to-source resistance of the internal MOSFET.

4.3 Output Voltage Load Regulation

Figure 2 shows the load regulation for the EVM.

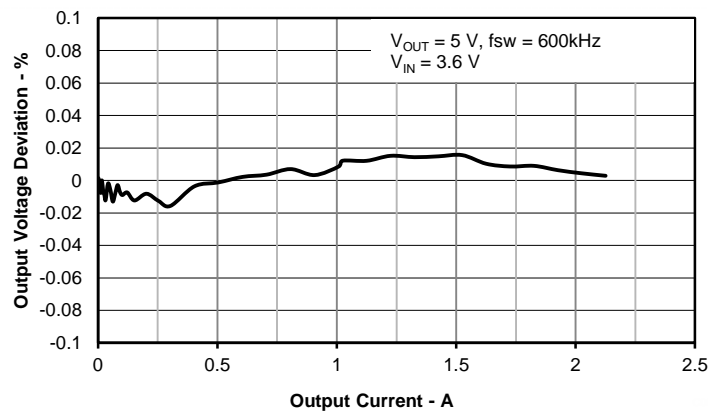

Figure 2. TPS55330EVM-017 Output Voltage Load Regulation

Measurements are for an ambient temperature of 25°C.

4.4 Output Voltage Line Regulation

Figure 3 shows the line regulation for the EVM with a 2.4-Ω (2.1 A) load.

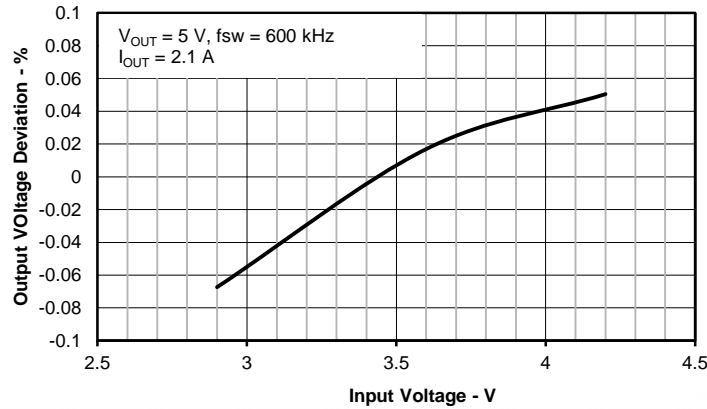

Figure 3. TPS55330EVM-017 Output Voltage Line Regulation

4.5 Load Transients

Figure 4 shows the EVM's response to load transients. The current step is from 25% to 75% of maximum rated load at a 3.6-V input respectively. The current step slew rate is 100 mA/μs. Total peak-to-peak voltage variation is as shown, including ripple and noise on the output.

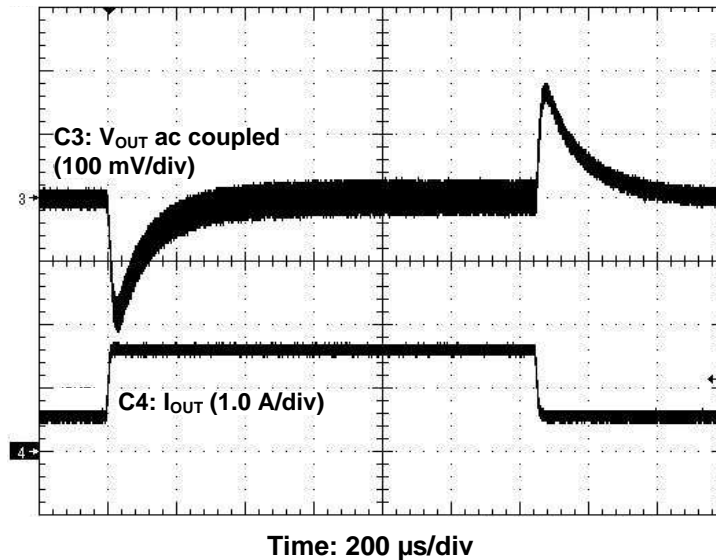

Figure 4. TPS55330EVM-017 $V_{IN} = 3.6\text{-V}$ Transient Response

4.6 Loop Characteristics

Figure 5 shows the EVM loop-response characteristics. Gain and phase plots are shown for V_{IN} voltage of 3.6 V with load current of 2.1 A.

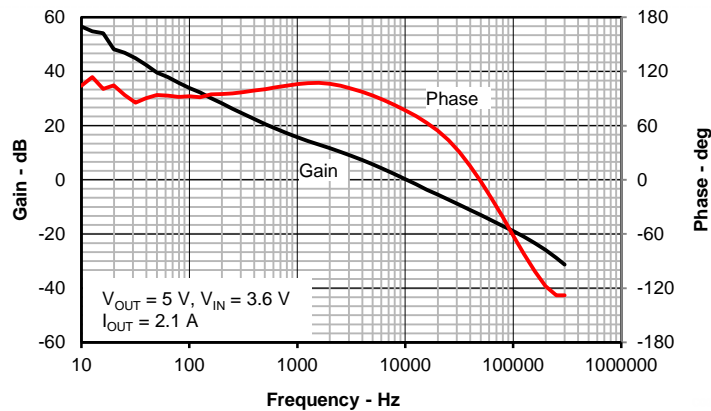

Figure 5. TPS55330EVM-017 Loop Response

4.7 Output Voltage Ripple

Figure 6 shows the EVM output voltage ripple and inductor current ripple. The output current is the rated full load of 2.1 A and $V_{IN} = 3.6$ V. The ripple voltage is measured directly across the output capacitors.

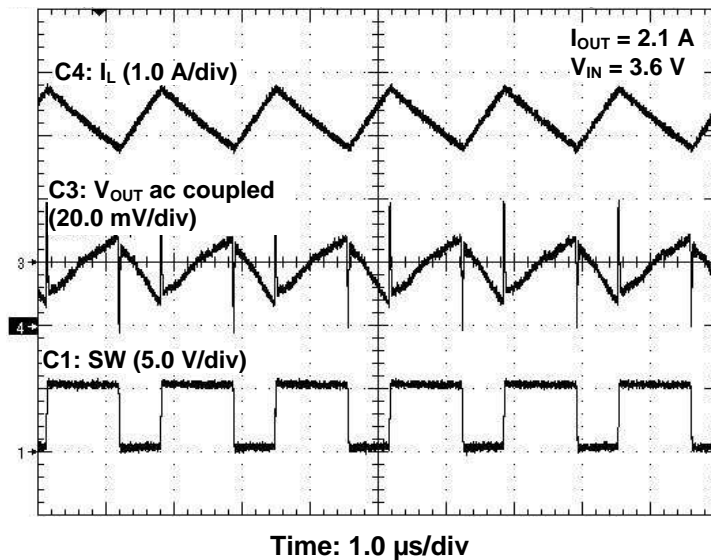

Figure 6. TPS55330EVM-017 $V_{IN} = 3.6$ -V Output Ripple

Figure 7 shows the EVM output voltage ripple, inductor current ripple and switching waveform while operating in discontinuous conduction mode (DCM). The input voltage is 3.6 V and the output is loaded with 100 mA.

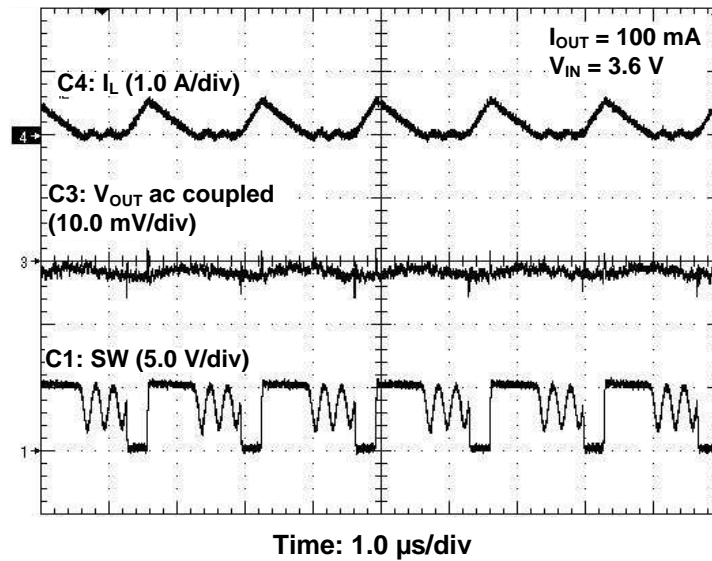

Figure 7. TPS55330EVM-017 DCM Output Ripple

4.8 Pulse-Skipping Operation

The TPS55330 features pulse-skipping for output regulation when operating at light loads. Figure 7 shows the output voltage ripple and the pulse-skipping at SW. The input voltage is 3.6 V.

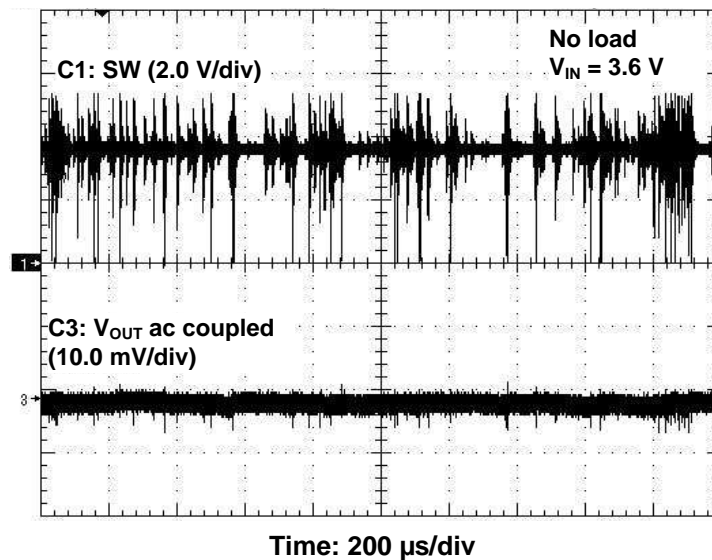

Figure 8. TPS55330EVM-017 $V_{IN} = 3.6\text{-V}$ Pulse-Skipping

4.9 Input Voltage Ripple

Figure 9 shows the EVM input voltage ripple at rated full load of 2.1 A at $V_{IN} = 3.6$ V. The ripple is measured directly across the input capacitor, C2.

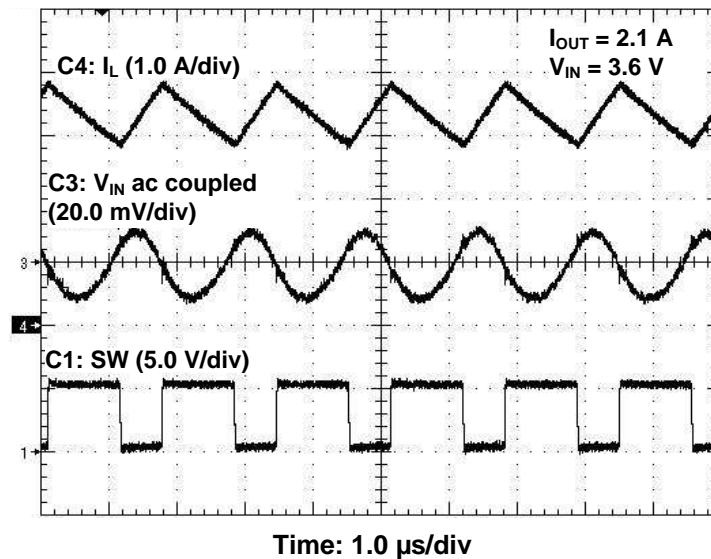

Figure 9. TPS55330EVM-017 $V_{IN} = 5$ -V Input Voltage Ripple

Figure 10 shows the EVM input voltage ripple in DCM operation with a 100 mA load at $V_{IN} = 3.6$ V. The ripple is measured directly across the input capacitor, C2.

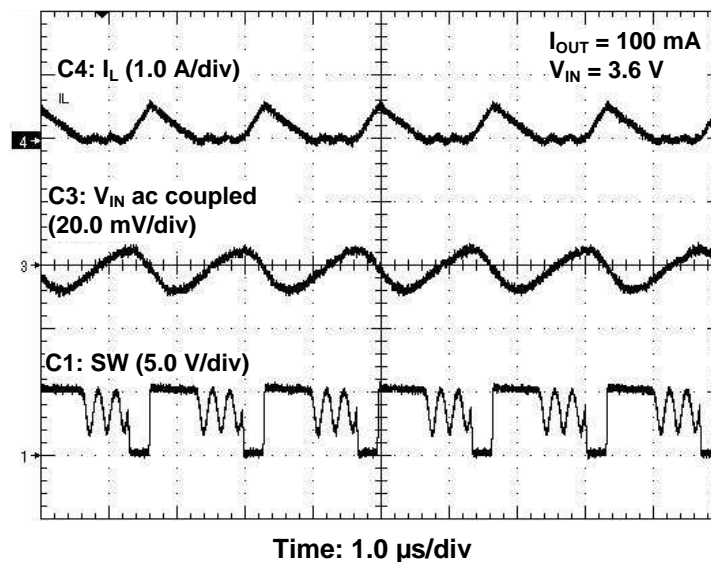

Figure 10. TPS55330EVM-017 $V_{IN} = 3.6$ -V Input Voltage Ripple

4.10 Powering Up and Down with EN

Figure 11 shows the start-up waveforms for the EVM. The input voltage is 3.6 V, the EN goes high and the output voltage ramps from V_{IN} to 5 V. The load is 2.1 A.

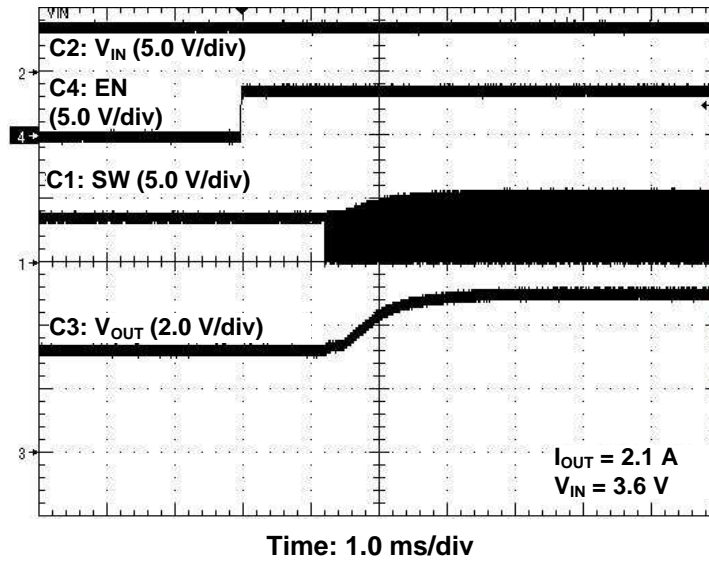

Figure 11. TPS55330EVM-017 Power Up With EN

Figure 12 shows the shutdown waveforms for the EVM. The input voltage is 3.6 V. The EN goes low and the output voltage ramps from 5 V to V_{IN} . The load is 2.1 A.

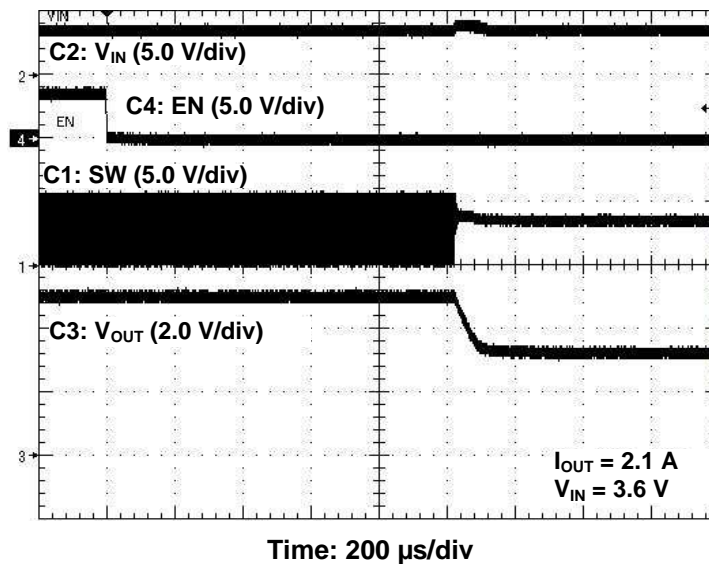

Figure 12. TPS55330EVM-017 Power Down With EN

4.11 Powering Up and Down with V_{IN}

Figure 13 shows the start-up waveforms for the EVM. The input voltage ramps with the input voltage power supply and EN is tied to V_{IN} . V_{IN} ramps up, the converter starts switching and the output voltage ramps to 5 V. The load is 2.1 A.

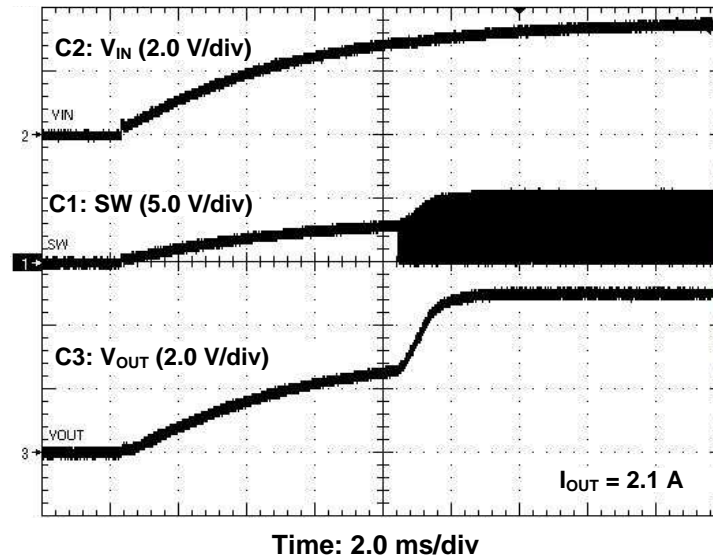

Figure 13. TPS55330EVM-017 Power Up With V_{IN}

Figure 14 shows the shutdown waveforms for the EVM. The input voltage ramps down with the input voltage power supply and EN is tied to V_{IN} . When V_{IN} is less than the 2.5-V typical UVLO, the converter stops switching and the output voltage ramps down. The load is 2.1 A.

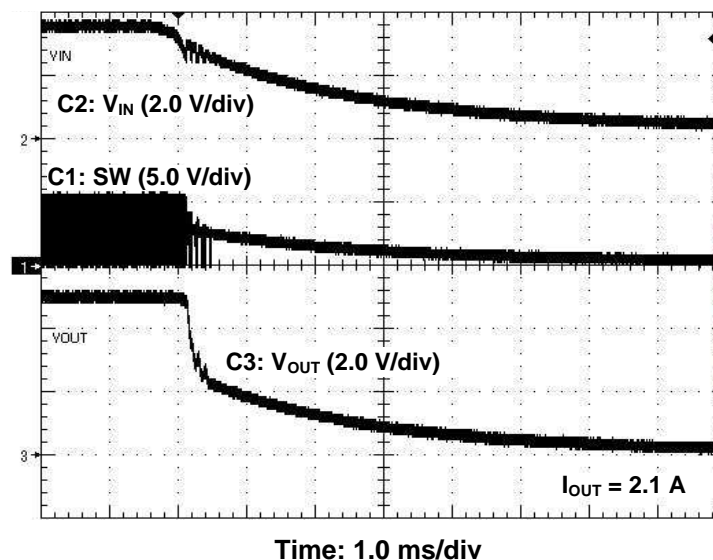

Figure 14. TPS55330EVM-017 Power Down With V_{IN}

5 Board Layout

This section provides a description of the EVM board layout and layer illustrations.

5.1 Layout

The board layout for the EVM is shown in Figure 15 through Figure 19. The top-side layer of the EVM is laid out in a manner typical of a user application. The top, bottom, and internal layers are 2-oz. copper.

The top layer contains the main power traces for V_{IN} , V_{OUT} , and SW. Also on the top layer are connections for the remaining pins of the TPS55330 and a large area filled with ground. The internal layers and bottom are primarily ground with additional fill areas for V_{IN} and V_{OUT} . The top-side ground traces connect to the bottom and internal ground planes with multiple vias placed around the board. Nine vias directly under the TPS55330 device provide a thermal path from the top-side ground plane to the bottom-side ground plane.

Place the output decoupling capacitors (C8–C11) as close to the IC as possible. The copper area of the SW node is kept small, minimizing noise. The vias near the diode, D1, on the V_{OUT} plane aid with thermal dissipation. Additionally, keep the voltage setpoint resistor divider components close to the IC. The voltage divider network ties to the output voltage at the point of regulation, the copper V_{OUT} trace at the J7 output connector. For the TPS55330, an additional input bulk capacitor may be necessary, depending on the EVM connection to the input supply. Critical analog circuits such as the voltage setpoint divider, frequency set resistor, slow-start capacitor, and compensation components terminate to ground using a separate ground trace on the top and bottom connected power ground, pour only at one point directly under the IC.

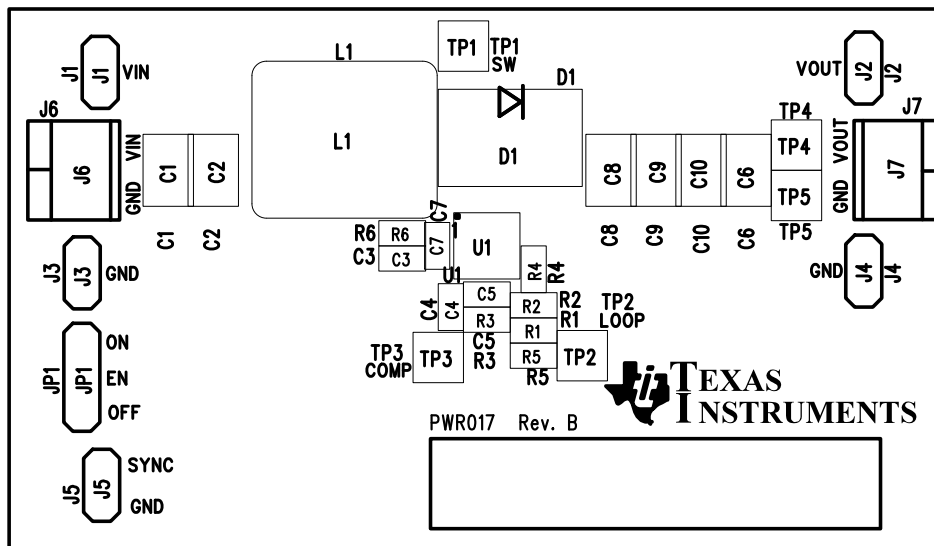

Figure 15. TPS55330EVM-017 Top-Side Assembly

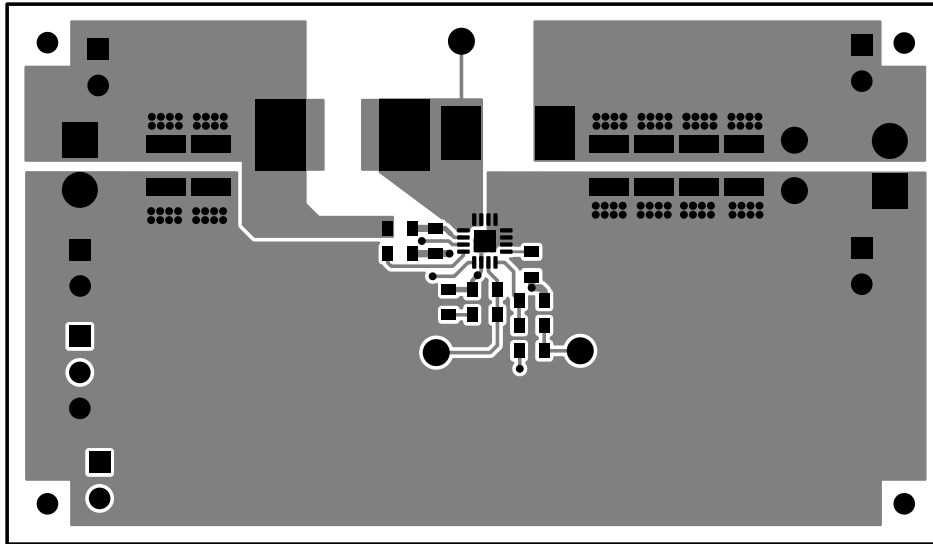

Figure 16. TPS55330EVM-017 Top-Side Layout

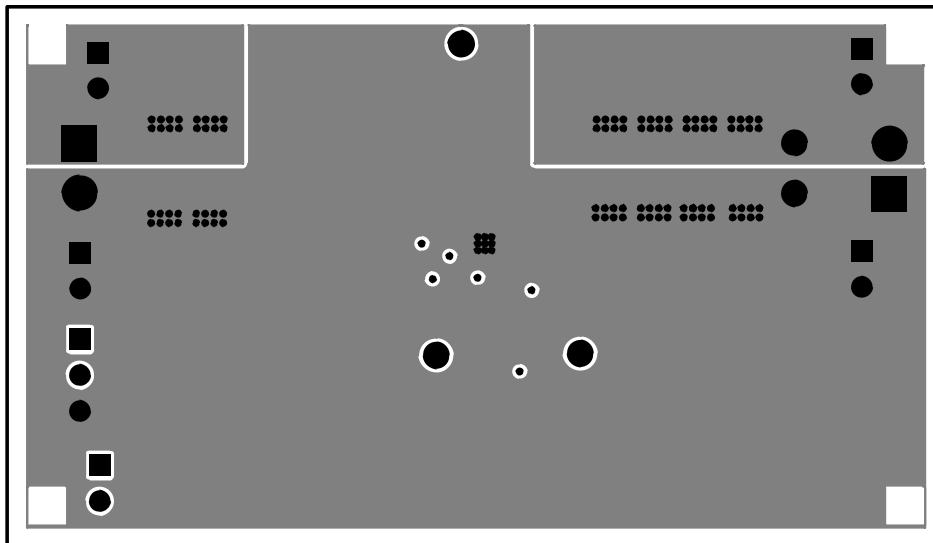

Figure 17. TPS55330EVM-017 Internal Layer-1 Layout

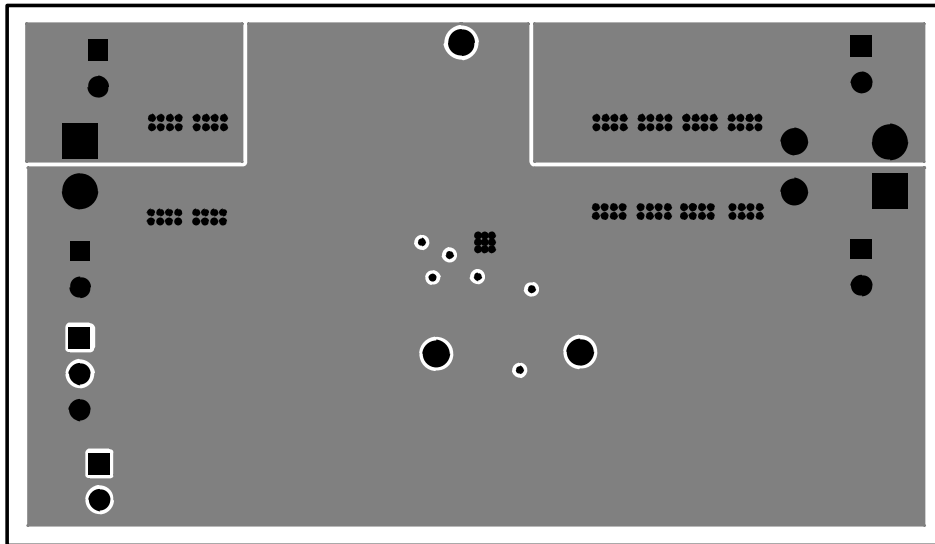

Figure 18. TPS55330EVM-017 Internal Layer-2 Layout

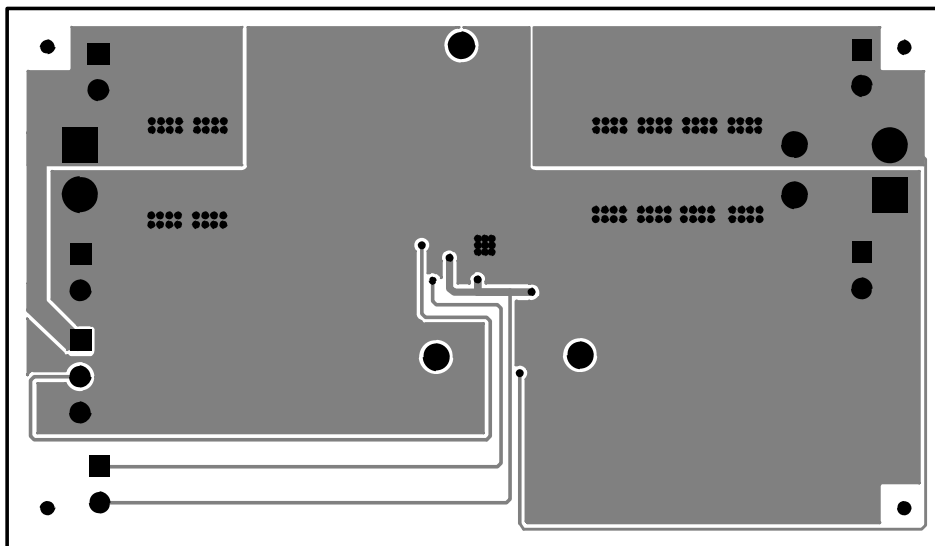

Figure 19. TPS55330EVM-017 Bottom-Side Layout

6 Schematic and Bill of Materials

This section presents the EVM schematic and bill of materials.

6.1 Schematic

Figure 20 is the schematic for the EVM.

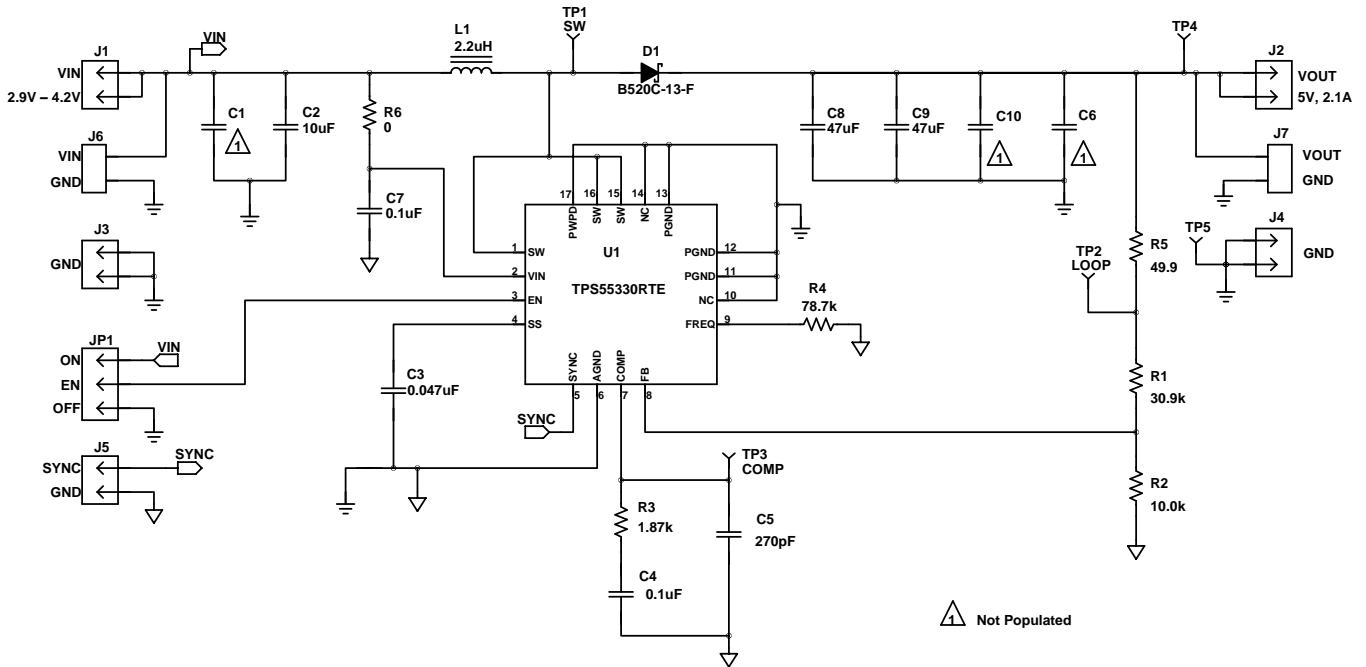

Figure 20. TPS55330EVM-017 Schematic

6.2 Bill of Materials

Table 4 presents the bill of materials for the EVM.

Table 4. TPS55330EVM-017 Bill of Materials

QTY	RefDes	Value	Description	Size	Part Number	MFR
0	C1	Open	Capacitor, ceramic	1210	STD	STD
1	C2	10 μ F	Capacitor, ceramic, 35 V, X7R, 10%	1210	STD	STD
1	C3	0.047 μ F	Capacitor, ceramic, 50 V, X7R, 10%	0603	STD	STD
1	C4	0.1 μ F	Capacitor, ceramic, 50 V, X7R, 10%	0603	STD	STD
1	C5	270 pF	Capacitor, ceramic, 50 V, NP0, 10%	0603	STD	STD
0	C6, C10	Open	Capacitor	1210	STD	STD
1	C7	0.1 μ F	Capacitor, ceramic, 50 V, X7R, 10%	0603	STD	STD
2	C8-C9	47 μ F	Capacitor, ceramic, 16 V, X7R, 10%	1210	STD	STD
1	D1	B520C-13-F	Diode, Schottky, 5 A, 20 V	SMC	B520C-13-F	Diodes Inc
5	J1-5	PEC025AAN	Header, Male 2-pin, 100 mil spacing	0.100 × 2 in	PEC025AAN	Suffins
2	J6-7	ED555/2DS	Terminal block, 2 pin, 6 A, 3.5 mm	0.27 × 0.25 in	ED555/205	OST
1	JP1	PEC035AAN	Header, Male 3 pin, 100 mil spacing	0.100 × 3 in	PEC035AAN	Sullins
1	L1	2.2 μ H	Inductor, SMT, 6.5 A, 18 m Ω	0.287 × 0.160 in	74437346022	Würth Elektronik
1	R1	30.9 k Ω	Resistor, chip, 1/16W, 1%	0603	STD	STD
1	R2	10.0 k Ω	Resistor, chip, 1/16W, 1%	0603	STD	
1	R3	1.87 k Ω	Resistor, chip, 1/16W, 1%	0603	STD	
1	R4	78.7 k Ω	Resistor, chip, 1/16W, 1%	0603	STD	
1	R5	49.9 Ω	Resistor, chip, 1/16W, 1%	0603	STD	
1	R6	0 Ω	Resistor, chip, 1/16W, 1%	0603	STD	
1	SH1		Short jumper, 100 mil	0.100 in	929950-00	3M
1	TP5	5001	Test point, black, Thru Hole Color Keyed	0.100 × 0.100 in		Keystone
4	TP1-4	5000	Test point, red, thru hole color keyed	0.100 × 0.100 in		Keystone
1	U1	TPS55330RTE	IC, 5-A, 24-V, Boost Converter with Soft-start and Programmable Switching Frequency	QFN-16	TPS55330RTE	TI
1	--		PCB, 2.6 in × 1.5 in × 0.062 in		PWR017	Any

Notes: 1. These assemblies are ESD sensitive, observe ESD precautions.
2. These assemblies must be clean and free from flux and all contaminants. Use of no clean flux is not acceptable.
3. These assemblies must comply with workmanship standards IPC-A-610 Class 2.
4. Ref designators marked with an asterisk (***) cannot be substituted. All other components can be substituted with equivalent MFG's components.

6.3 Reference

1. *TPS55330, Integrated 5-A 24-V Boost/SEPIC/Flyback DC-DC Regulator* data sheet ([SLVSBX8](#))

EVALUATION BOARD/KIT/MODULE (EVM) ADDITIONAL TERMS

Texas Instruments (TI) provides the enclosed Evaluation Board/Kit/Module (EVM) under the following conditions:

The user assumes all responsibility and liability for proper and safe handling of the goods. Further, the user indemnifies TI from all claims arising from the handling or use of the goods.

Should this evaluation board/kit not meet the specifications indicated in the User's Guide, the board/kit may be returned within 30 days from the date of delivery for a full refund. THE FOREGOING LIMITED WARRANTY IS THE EXCLUSIVE WARRANTY MADE BY SELLER TO BUYER AND IS IN LIEU OF ALL OTHER WARRANTIES, EXPRESSED, IMPLIED, OR STATUTORY, INCLUDING ANY WARRANTY OF MERCHANTABILITY OR FITNESS FOR ANY PARTICULAR PURPOSE. EXCEPT TO THE EXTENT OF THE INDEMNITY SET FORTH ABOVE, NEITHER PARTY SHALL BE LIABLE TO THE OTHER FOR ANY INDIRECT, SPECIAL, INCIDENTAL, OR CONSEQUENTIAL DAMAGES.

Please read the User's Guide and, specifically, the Warnings and Restrictions notice in the User's Guide prior to handling the product. This notice contains important safety information about temperatures and voltages. For additional information on TI's environmental and/or safety programs, please visit www.ti.com/esh or contact TI.

No license is granted under any patent right or other intellectual property right of TI covering or relating to any machine, process, or combination in which such TI products or services might be or are used. TI currently deals with a variety of customers for products, and therefore our arrangement with the user is not exclusive. TI assumes no liability for applications assistance, customer product design, software performance, or infringement of patents or services described herein.

REGULATORY COMPLIANCE INFORMATION

As noted in the EVM User's Guide and/or EVM itself, this EVM and/or accompanying hardware may or may not be subject to the Federal Communications Commission (FCC) and Industry Canada (IC) rules.

For EVMs **not** subject to the above rules, this evaluation board/kit/module is intended for use for ENGINEERING DEVELOPMENT, DEMONSTRATION OR EVALUATION PURPOSES ONLY and is not considered by TI to be a finished end product fit for general consumer use. It generates, uses, and can radiate radio frequency energy and has not been tested for compliance with the limits of computing devices pursuant to part 15 of FCC or ICES-003 rules, which are designed to provide reasonable protection against radio frequency interference. Operation of the equipment may cause interference with radio communications, in which case the user at his own expense will be required to take whatever measures may be required to correct this interference.

General Statement for EVMs including a radio

User Power/Frequency Use Obligations: This radio is intended for development/professional use only in legally allocated frequency and power limits. Any use of radio frequencies and/or power availability of this EVM and its development application(s) must comply with local laws governing radio spectrum allocation and power limits for this evaluation module. It is the user's sole responsibility to only operate this radio in legally acceptable frequency space and within legally mandated power limitations. Any exceptions to this are strictly prohibited and unauthorized by Texas Instruments unless user has obtained appropriate experimental/development licenses from local regulatory authorities, which is responsibility of user including its acceptable authorization.

For EVMs annotated as FCC – FEDERAL COMMUNICATIONS COMMISSION Part 15 Compliant

Caution

This device complies with part 15 of the FCC Rules. Operation is subject to the following two conditions: (1) This device may not cause harmful interference, and (2) this device must accept any interference received, including interference that may cause undesired operation.

Changes or modifications not expressly approved by the party responsible for compliance could void the user's authority to operate the equipment.

FCC Interference Statement for Class A EVM devices

This equipment has been tested and found to comply with the limits for a Class A digital device, pursuant to part 15 of the FCC Rules. These limits are designed to provide reasonable protection against harmful interference when the equipment is operated in a commercial environment. This equipment generates, uses, and can radiate radio frequency energy and, if not installed and used in accordance with the instruction manual, may cause harmful interference to radio communications. Operation of this equipment in a residential area is likely to cause harmful interference in which case the user will be required to correct the interference at his own expense.

FCC Interference Statement for Class B EVM devices

This equipment has been tested and found to comply with the limits for a Class B digital device, pursuant to part 15 of the FCC Rules. These limits are designed to provide reasonable protection against harmful interference in a residential installation. This equipment generates, uses and can radiate radio frequency energy and, if not installed and used in accordance with the instructions, may cause harmful interference to radio communications. However, there is no guarantee that interference will not occur in a particular installation. If this equipment does cause harmful interference to radio or television reception, which can be determined by turning the equipment off and on, the user is encouraged to try to correct the interference by one or more of the following measures:

- Reorient or relocate the receiving antenna.
- Increase the separation between the equipment and receiver.
- Connect the equipment into an outlet on a circuit different from that to which the receiver is connected.
- Consult the dealer or an experienced radio/TV technician for help.

For EVMs annotated as IC – INDUSTRY CANADA Compliant

This Class A or B digital apparatus complies with Canadian ICES-003.

Changes or modifications not expressly approved by the party responsible for compliance could void the user's authority to operate the equipment.

Concerning EVMs including radio transmitters

This device complies with Industry Canada licence-exempt RSS standard(s). Operation is subject to the following two conditions: (1) this device may not cause interference, and (2) this device must accept any interference, including interference that may cause undesired operation of the device.

Concerning EVMs including detachable antennas

Under Industry Canada regulations, this radio transmitter may only operate using an antenna of a type and maximum (or lesser) gain approved for the transmitter by Industry Canada. To reduce potential radio interference to other users, the antenna type and its gain should be so chosen that the equivalent isotropically radiated power (e.i.r.p.) is not more than that necessary for successful communication.

This radio transmitter has been approved by Industry Canada to operate with the antenna types listed in the user guide with the maximum permissible gain and required antenna impedance for each antenna type indicated. Antenna types not included in this list, having a gain greater than the maximum gain indicated for that type, are strictly prohibited for use with this device.

Cet appareil numérique de la classe A ou B est conforme à la norme NMB-003 du Canada.

Les changements ou les modifications pas expressément approuvés par la partie responsable de la conformité ont pu vider l'autorité de l'utilisateur pour actionner l'équipement.

Concernant les EVMs avec appareils radio

Le présent appareil est conforme aux CNR d'Industrie Canada applicables aux appareils radio exempts de licence. L'exploitation est autorisée aux deux conditions suivantes : (1) l'appareil ne doit pas produire de brouillage, et (2) l'utilisateur de l'appareil doit accepter tout brouillage radioélectrique subi, même si le brouillage est susceptible d'en compromettre le fonctionnement.

Concernant les EVMs avec antennes détachables

Conformément à la réglementation d'Industrie Canada, le présent émetteur radio peut fonctionner avec une antenne d'un type et d'un gain maximal (ou inférieur) approuvé pour l'émetteur par Industrie Canada. Dans le but de réduire les risques de brouillage radioélectrique à l'intention des autres utilisateurs, il faut choisir le type d'antenne et son gain de sorte que la puissance isotrope rayonnée équivalente (p.i.r.e.) ne dépasse pas l'intensité nécessaire à l'établissement d'une communication satisfaisante.

Le présent émetteur radio a été approuvé par Industrie Canada pour fonctionner avec les types d'antenne énumérés dans le manuel d'usage et ayant un gain admissible maximal et l'impédance requise pour chaque type d'antenne. Les types d'antenne non inclus dans cette liste, ou dont le gain est supérieur au gain maximal indiqué, sont strictement interdits pour l'exploitation de l'émetteur.

【Important Notice for Users of EVMs for RF Products in Japan】

This development kit is NOT certified as Confirming to Technical Regulations of Radio Law of Japan

If you use this product in Japan, you are required by Radio Law of Japan to follow the instructions below with respect to this product:

1. Use this product in a shielded room or any other test facility as defined in the notification #173 issued by Ministry of Internal Affairs and Communications on March 28, 2006, based on Sub-section 1.1 of Article 6 of the Ministry's Rule for Enforcement of Radio Law of Japan,
2. Use this product only after you obtained the license of Test Radio Station as provided in Radio Law of Japan with respect to this product, or
3. Use of this product only after you obtained the Technical Regulations Conformity Certification as provided in Radio Law of Japan with respect to this product. Also, please do not transfer this product, unless you give the same notice above to the transferee. Please note that if you could not follow the instructions above, you will be subject to penalties of Radio Law of Japan.

Texas Instruments Japan Limited
(address) 24-1, Nishi-Shinjuku 6 chome, Shinjuku-ku, Tokyo, Japan

<http://www.tij.co.jp>

【無線電波を送信する製品の開発キットをお使いになる際の注意事項】

本開発キットは技術基準適合証明を受けておりません。

本製品のご使用に際しては、電波法遵守のため、以下のいずれかの措置を取っていただく必要がありますのでご注意ください。

1. 電波法施行規則第6条第1項第1号に基づく平成18年3月28日総務省告示第173号で定められた電波暗室等の試験設備でご使用いただく。
2. 実験局の免許を取得後ご使用いただく。
3. 技術基準適合証明を取得後ご使用いただく。

なお、本製品は、上記の「ご使用にあたっての注意」を譲渡先、移転先に通知しない限り、譲渡、移転できないものとします。

上記を遵守頂けない場合は、電波法の罰則が適用される可能性があることをご留意ください。

日本テキサス・インスツルメンツ株式会社
東京都新宿区西新宿6丁目24番1号
西新宿三井ビル

<http://www.tij.co.jp>

EVALUATION BOARD/KIT/MODULE (EVM) WARNINGS, RESTRICTIONS AND DISCLAIMERS

For Feasibility Evaluation Only, in Laboratory/Development Environments. Unless otherwise indicated, this EVM is not a finished electrical equipment and not intended for consumer use. It is intended solely for use for preliminary feasibility evaluation in laboratory/development environments by technically qualified electronics experts who are familiar with the dangers and application risks associated with handling electrical mechanical components, systems and subsystems. It should not be used as all or part of a finished end product.

Your Sole Responsibility and Risk. You acknowledge, represent and agree that:

1. You have unique knowledge concerning Federal, State and local regulatory requirements (including but not limited to Food and Drug Administration regulations, if applicable) which relate to your products and which relate to your use (and/or that of your employees, affiliates, contractors or designees) of the EVM for evaluation, testing and other purposes.
2. You have full and exclusive responsibility to assure the safety and compliance of your products with all such laws and other applicable regulatory requirements, and also to assure the safety of any activities to be conducted by you and/or your employees, affiliates, contractors or designees, using the EVM. Further, you are responsible to assure that any interfaces (electronic and/or mechanical) between the EVM and any human body are designed with suitable isolation and means to safely limit accessible leakage currents to minimize the risk of electrical shock hazard.
3. Since the EVM is not a completed product, it may not meet all applicable regulatory and safety compliance standards (such as UL, CSA, VDE, CE, RoHS and WEEE) which may normally be associated with similar items. You assume full responsibility to determine and/or assure compliance with any such standards and related certifications as may be applicable. You will employ reasonable safeguards to ensure that your use of the EVM will not result in any property damage, injury or death, even if the EVM should fail to perform as described or expected.
4. You will take care of proper disposal and recycling of the EVM's electronic components and packing materials.

Certain Instructions. It is important to operate this EVM within TI's recommended specifications and environmental considerations per the user guidelines. Exceeding the specified EVM ratings (including but not limited to input and output voltage, current, power, and environmental ranges) may cause property damage, personal injury or death. If there are questions concerning these ratings please contact a TI field representative prior to connecting interface electronics including input power and intended loads. Any loads applied outside of the specified output range may result in unintended and/or inaccurate operation and/or possible permanent damage to the EVM and/or interface electronics. Please consult the EVM User's Guide prior to connecting any load to the EVM output. If there is uncertainty as to the load specification, please contact a TI field representative. During normal operation, some circuit components may have case temperatures greater than 60°C as long as the input and output are maintained at a normal ambient operating temperature. These components include but are not limited to linear regulators, switching transistors, pass transistors, and current sense resistors which can be identified using the EVM schematic located in the EVM User's Guide. When placing measurement probes near these devices during normal operation, please be aware that these devices may be very warm to the touch. As with all electronic evaluation tools, only qualified personnel knowledgeable in electronic measurement and diagnostics normally found in development environments should use these EVMs.

Agreement to Defend, Indemnify and Hold Harmless. You agree to defend, indemnify and hold TI, its licensors and their representatives harmless from and against any and all claims, damages, losses, expenses, costs and liabilities (collectively, "Claims") arising out of or in connection with any use of the EVM that is not in accordance with the terms of the agreement. This obligation shall apply whether Claims arise under law of tort or contract or any other legal theory, and even if the EVM fails to perform as described or expected.

Safety-Critical or Life-Critical Applications. If you intend to evaluate the components for possible use in safety critical applications (such as life support) where a failure of the TI product would reasonably be expected to cause severe personal injury or death, such as devices which are classified as FDA Class III or similar classification, then you must specifically notify TI of such intent and enter into a separate Assurance and Indemnity Agreement.

Mailing Address: Texas Instruments, Post Office Box 655303, Dallas, Texas 75265
Copyright © 2013, Texas Instruments Incorporated

IMPORTANT NOTICE

Texas Instruments Incorporated and its subsidiaries (TI) reserve the right to make corrections, enhancements, improvements and other changes to its semiconductor products and services per JESD46, latest issue, and to discontinue any product or service per JESD48, latest issue. Buyers should obtain the latest relevant information before placing orders and should verify that such information is current and complete. All semiconductor products (also referred to herein as "components") are sold subject to TI's terms and conditions of sale supplied at the time of order acknowledgment.

TI warrants performance of its components to the specifications applicable at the time of sale, in accordance with the warranty in TI's terms and conditions of sale of semiconductor products. Testing and other quality control techniques are used to the extent TI deems necessary to support this warranty. Except where mandated by applicable law, testing of all parameters of each component is not necessarily performed.

TI assumes no liability for applications assistance or the design of Buyers' products. Buyers are responsible for their products and applications using TI components. To minimize the risks associated with Buyers' products and applications, Buyers should provide adequate design and operating safeguards.

TI does not warrant or represent that any license, either express or implied, is granted under any patent right, copyright, mask work right, or other intellectual property right relating to any combination, machine, or process in which TI components or services are used. Information published by TI regarding third-party products or services does not constitute a license to use such products or services or a warranty or endorsement thereof. Use of such information may require a license from a third party under the patents or other intellectual property of the third party, or a license from TI under the patents or other intellectual property of TI.

Reproduction of significant portions of TI information in TI data books or data sheets is permissible only if reproduction is without alteration and is accompanied by all associated warranties, conditions, limitations, and notices. TI is not responsible or liable for such altered documentation. Information of third parties may be subject to additional restrictions.

Resale of TI components or services with statements different from or beyond the parameters stated by TI for that component or service voids all express and any implied warranties for the associated TI component or service and is an unfair and deceptive business practice. TI is not responsible or liable for any such statements.

Buyer acknowledges and agrees that it is solely responsible for compliance with all legal, regulatory and safety-related requirements concerning its products, and any use of TI components in its applications, notwithstanding any applications-related information or support that may be provided by TI. Buyer represents and agrees that it has all the necessary expertise to create and implement safeguards which anticipate dangerous consequences of failures, monitor failures and their consequences, lessen the likelihood of failures that might cause harm and take appropriate remedial actions. Buyer will fully indemnify TI and its representatives against any damages arising out of the use of any TI components in safety-critical applications.

In some cases, TI components may be promoted specifically to facilitate safety-related applications. With such components, TI's goal is to help enable customers to design and create their own end-product solutions that meet applicable functional safety standards and requirements. Nonetheless, such components are subject to these terms.

No TI components are authorized for use in FDA Class III (or similar life-critical medical equipment) unless authorized officers of the parties have executed a special agreement specifically governing such use.

Only those TI components which TI has specifically designated as military grade or "enhanced plastic" are designed and intended for use in military/aerospace applications or environments. Buyer acknowledges and agrees that any military or aerospace use of TI components which have **not** been so designated is solely at the Buyer's risk, and that Buyer is solely responsible for compliance with all legal and regulatory requirements in connection with such use.

TI has specifically designated certain components as meeting ISO/TS16949 requirements, mainly for automotive use. In any case of use of non-designated products, TI will not be responsible for any failure to meet ISO/TS16949.

Products

Audio	www.ti.com/audio
Amplifiers	amplifier.ti.com
Data Converters	dataconverter.ti.com
DLP® Products	www.dlp.com
DSP	dsp.ti.com
Clocks and Timers	www.ti.com/clocks
Interface	interface.ti.com
Logic	logic.ti.com
Power Mgmt	power.ti.com
Microcontrollers	microcontroller.ti.com
RFID	www.ti-rfid.com
OMAP Applications Processors	www.ti.com/omap
Wireless Connectivity	www.ti.com/wirelessconnectivity

Applications

Automotive and Transportation	www.ti.com/automotive
Communications and Telecom	www.ti.com/communications
Computers and Peripherals	www.ti.com/computers
Consumer Electronics	www.ti.com/consumer-apps
Energy and Lighting	www.ti.com/energy
Industrial	www.ti.com/industrial
Medical	www.ti.com/medical
Security	www.ti.com/security
Space, Avionics and Defense	www.ti.com/space-avionics-defense
Video and Imaging	www.ti.com/video

TI E2E Community

e2e.ti.com