



EV3416-QH-00B

1.1A Switching Current, Low- I_Q , Step-Up Converter with Output Disconnect Evaluation Board

DESCRIPTION

The EV3416-QH-00A is an evaluation board designed to demonstrate the capabilities of the MP3416, a 1.1A switching current, low quiescent current (I_Q), step-up converter with output disconnect.

Peak current control provides fast transient response. The integrated, synchronous P-channel rectifier improves efficiency and eliminates the need for an external Schottky diode.

The MP3416 employs pulse-skip mode (PSM) to reduce power loss during light-load operation. During shutdown, the output disconnects from input to allow for a shutdown current (I_{SD}) below $0.65\mu A$.

The MP3416 is available in a small QFN-8 (1.5mmx2mm) package.

ELECTRICAL SPECIFICATIONS

Parameter	Symbol	Value	Units
Input voltage	V_{IN}	0.86 to 5.5	V
Startup voltage	V_{START}	1.25 to 5.5	V
Output voltage	V_{OUT}	3.3	V

FEATURES

- 0.86V to 5.5V Operating Input Voltage (V_{IN}) Range
- 1.25V to 5.5V Start-Up Voltage Range
- 1.8V to 5.5V Output Voltage (V_{OUT}) Range
- $9.5\mu A$ Quiescent Current (I_Q)
- $<0.65\mu A$ Shutdown Current (I_{SD})
- Up to 80% Efficiency under Light-Load Conditions ($100\mu A$ to $200\mu A$)
- Output Disconnect during Shutdown
- Down Mode when $V_{IN} > V_{OUT}$
- Adjustable Low-Battery Detection
- Internal Synchronous Rectifier
- OTP with Thermal Shutdown at $155^\circ C$
- Available in a QFN-8 (1.5mmx2mm) Package

APPLICATIONS

- Medical Devices
- Digital Retail Displays
- Gaming Controllers
- Remote Controls
- Battery-Powered Products
- Handheld Computers and Smartphones

All MPS parts are lead-free, halogen-free, and adhere to the RoHS directive. For MPS green status, please visit the MPS website under Quality Assurance. "MPS", the MPS logo, and "Simple, Easy Solutions" are trademarks of Monolithic Power Systems, Inc. or its subsidiaries.

EV3416-QH-00B EVALUATION BOARD



LxWxH (6.35cmx6.35cmx0.6cm)

Board Number	MPS IC Number	MPS Inductor
EV3416-QH-00B	MP3416GQH	MPL-AL5030-3R3

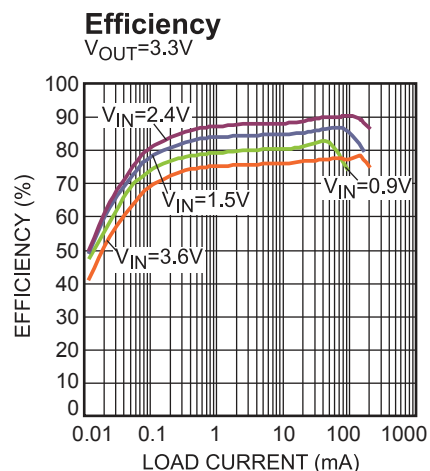

QUICK START GUIDE

The evaluation board's output voltage (V_{OUT}) is set at 3.3V. The board layout accommodates most commonly used components.

1. Preset the power supply between 1.25V and 5.5V.
2. Turn off the power supply.
3. Connect the power supply terminals to:
 - a. Positive (+): VIN
 - b. Negative (-): GND
4. Connect the load terminals to:
 - a. Positive (+): VOUT
 - b. Negative (-): GND
5. After making the connections, turn on the power supply. The board should start up automatically.
6. A resistor (R2) sets V_{OUT} . The adjusted V_{OUT} can be calculated with Equation (1):

$$V_{OUT} = V_{FB} \times \left(1 + \frac{R1}{R2}\right) \quad (1)$$

Where V_{FB} is the feedback voltage (0.504V), and R1 is 1M Ω .

7. To use the enable (EN) function, apply a digital input to the EN pin. Pull EN above 0.7V to turn the converter on; pull EN below 0.2V to turn it off.

EVALUATION BOARD SCHEMATIC

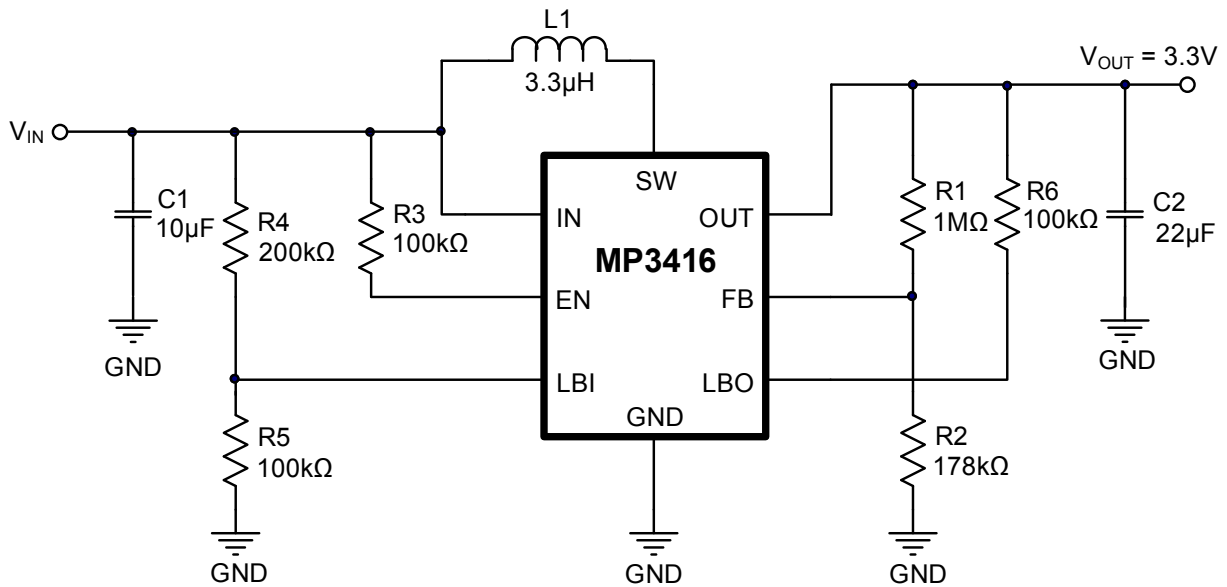

Figure 1: Evaluation Board Schematic

EV3416-QH-00B BILL OF MATERIALS

Qty	Ref	Value	Description	Package	Manufacturer	Manufacturer PN
1	C1	10 μ F	Ceramic capacitor, 10V	0805	Murata	GRM219R61A106KE44D
1	C2	22 μ F	Ceramic capacitor, 6.3V	0805	Murata	GRM21BR60J226ME39L
1	L1 ⁽¹⁾	3.3 μ H	Inductor, I _{SAT} = 6A, RDC = 21m Ω	SMD	MPS	MPL-AL5030-3R3
			Inductor, I _{SAT} = 1.8A, RDC = 65m Ω	SMD	Würth	744042003
1	R1	1M Ω	Film resistor, 1%	0603	Yageo	RC0603FR-071ML
1	R2	178k Ω	Film resistor, 1%	0603	Yageo	RC0603FR-07178KL
3	R3, R5, R6	100k Ω	Film resistor, 1%	0603	Yageo	RC0603FR-07100KL
1	R4	200k Ω	Film resistor, 1%	0603	Yageo	RC0603FR-07200KL
1	U1	MP3416	Boost Converter	QFN-8 (1.5mmx2mm)	MPS	MP3416GQH-Z

Note:

- 1) Older versions of the EV3416-QH-00B evaluation board included the Würth inductor listed in the EV3416-QH-00B Bill of Materials (BOM). Newer versions of the evaluation board include the MPS inductor listed in the BOM.

EVB TEST RESULTS

$V_{IN} = 1.8V$, $V_{OUT} = 3.3V$, $L = 3.3\mu H$, $T_A = 25^\circ C$, unless otherwise noted.

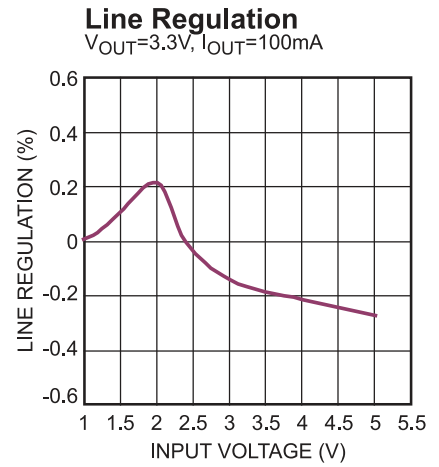
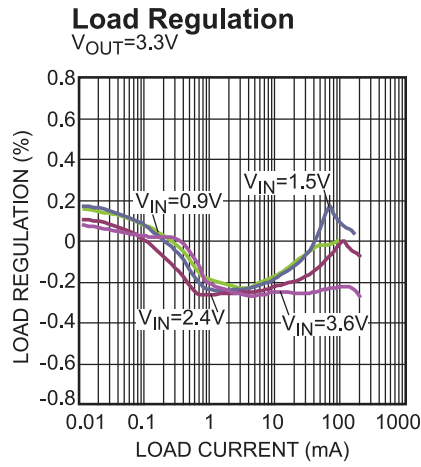
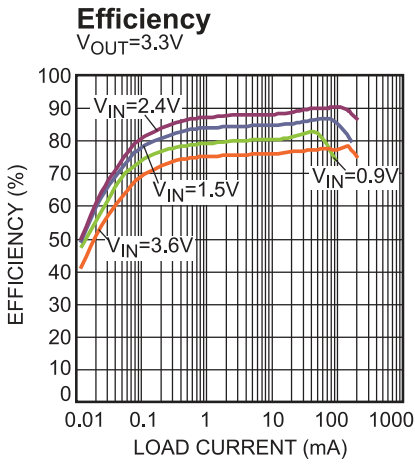

SW Frequency vs. Load Current

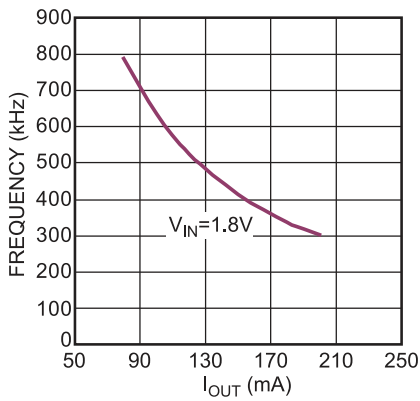

EVB TEST RESULTS (continued)
 $V_{IN} = 1.8V$, $V_{OUT} = 3.3V$, $L = 3.3\mu H$, $T_A = 25^\circ C$, unless otherwise noted.

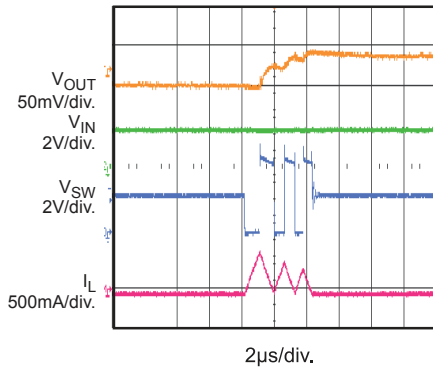
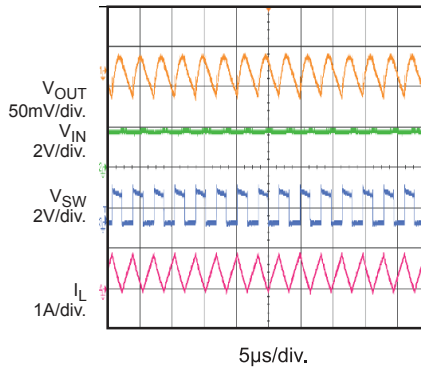
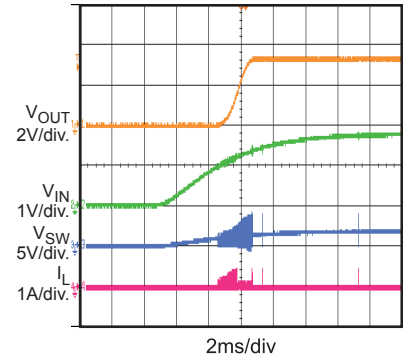
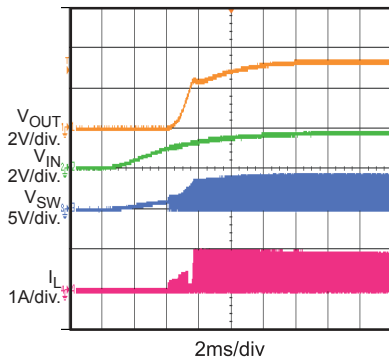
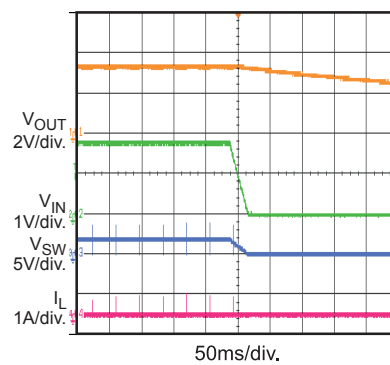
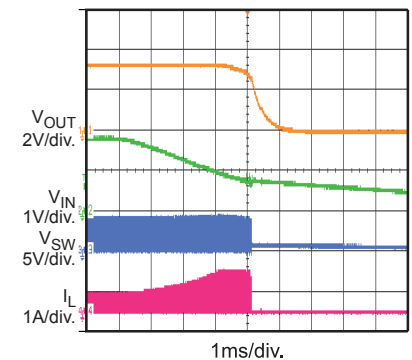
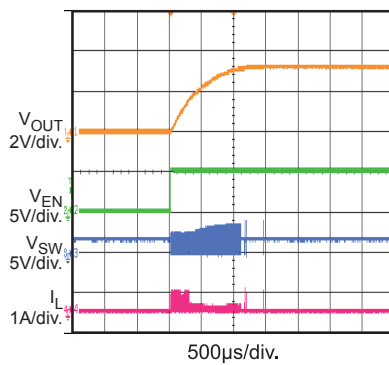
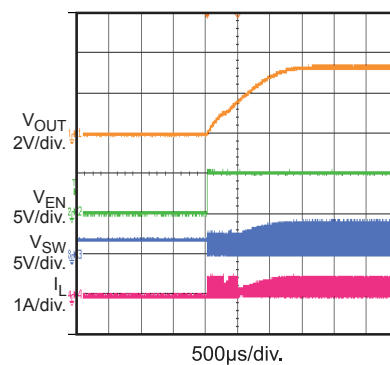
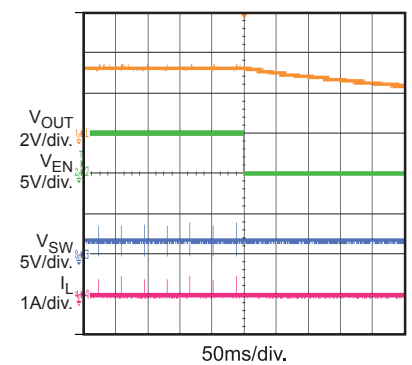
Output Ripple
 $I_{OUT} = 0A$

Output Ripple
 $I_{OUT} = 0.2A$

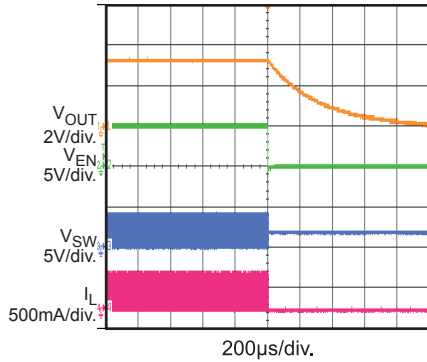
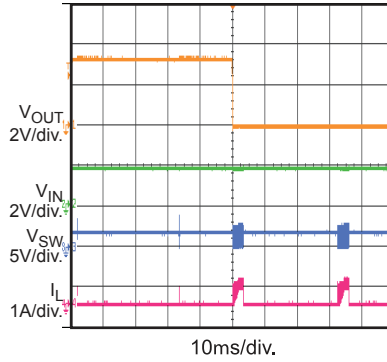
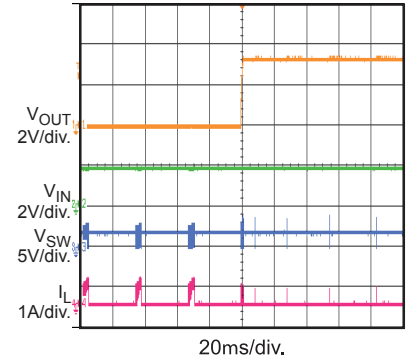
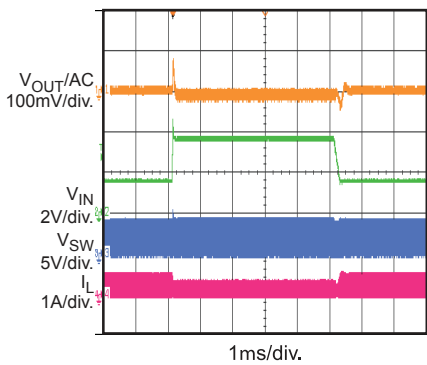
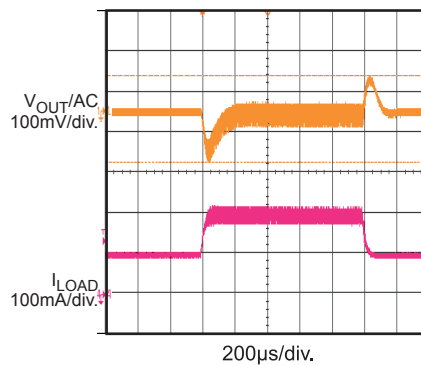
 V_{IN} Startup
 $I_{OUT} = 0A$

 V_{IN} Startup
 $I_{OUT} = 0.2A$

 V_{IN} Shutdown
 $I_{OUT} = 0A$

 V_{IN} Shutdown
 $I_{OUT} = 0.2A$

EN Startup
 $I_{OUT} = 0A$

EN Startup
 $I_{OUT} = 0.2A$

EN Shutdown
 $I_{OUT} = 0A$

EVB TEST RESULTS (continued)
 $V_{IN} = 1.8V$, $V_{OUT} = 3.3V$, $L = 3.3\mu H$, $T_A = 25^\circ C$, unless otherwise noted.

EN Shutdown
 $I_{OUT} = 0.2A$

SCP Enter

SCP Recover

Line Transient
 $V_{IN} = 1.8V$ to $3.6V$, $I_{OUT} = 0.1A$

Load Transient
 $I_{OUT} = 0.1A$ to $0.2A$

PCB LAYOUT

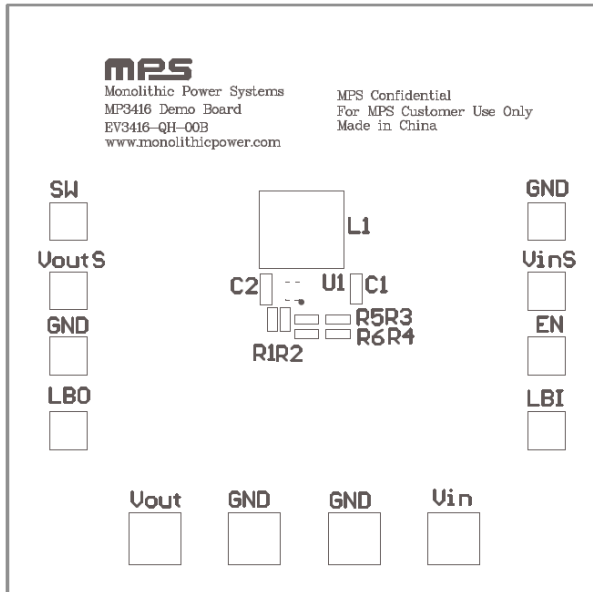

Figure 2: Top Silk

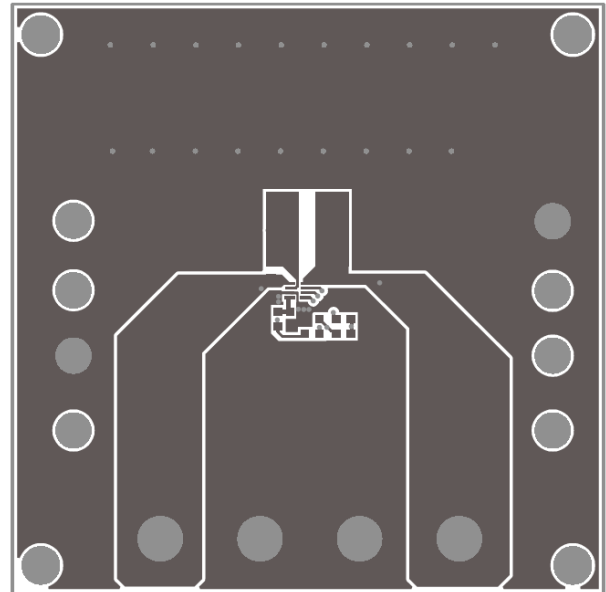

Figure 3: Top Layer

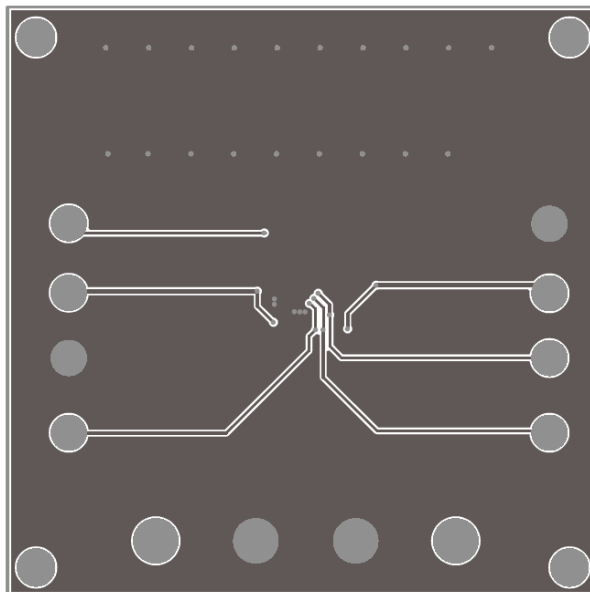

Figure 4: Bottom Layer



REVISION HISTORY

Revision #	Revision Date	Description	Pages Updated
1.0	11/4/2016	Initial Release	-
1.1	5/28/2021	Updated the Description and Features sections; updated the footnote below the Application section; added the evaluation board height and MPS inductor information to the EV3416-QH-00B Evaluation Board section	1
		Updated the Quick Start Guide section	2
		Added the MPS inductor information to the EV3416-QH-00B Bill of Materials section	4
		Formatting and clerical updates; updated headers and footers; updated pagination; updated figure titles	All

Notice: The information in this document is subject to change without notice. Please contact MPS for current specifications. Users should warrant and guarantee that third-party Intellectual Property rights are not infringed upon when integrating MPS products into any application. MPS will not assume any legal responsibility for any said applications.