

Ultra Low Profile Stacker: BTB

00-9258

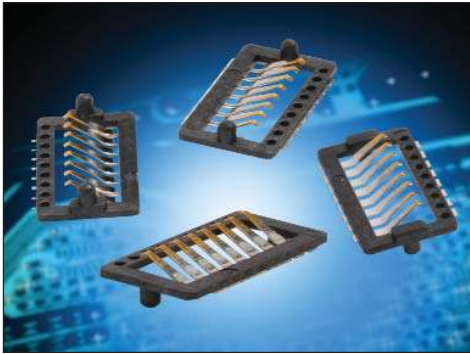

The SOLO series 9258 is a one-piece connector used to connect two PCBs in a cost effective manner.

This connector is a 1.0mm pitch available in an 8 position with stack heights of 0.40mm and 0.80mm. It is available with or without location bosses.

This connector is designed for PCB surface mounting and is supplied in tape and reel packaging. Gold plated pads on the mating PCB or suitable flex circuits provide connection between the boards.

APPLICATIONS

- Mobile phones
- Handheld scanners
- Portable medical devices
- Display interface

FEATURES AND BENEFITS

Single piece connector – no mating half connector required to connect two boards together which means:

- Reduced assembly time
- Only one part to purchase and stock
- Due to the unique contact design, the mating device does not have to be parallel
- Extremely robust when it comes to shock and vibration

ELECTRICAL

- Current Rating: 1 Amp/Contact
- Voltage Rating: 125V
Based on placement distance

ENVIRONMENTAL

- Operating Temperature:
-55°C to +125°C

MECHANICAL

- Insulator Material: High Temperature Plastic; UL94 V-0
- Contact Material: Beryllium Copper
- Plating: Gold over Nickel
- Durability: 50 Cycles

HOW TO ORDER

00 Prefix
9258 Series
008 Number of Ways
008 = 8

00X Connector Height

Code	Stack Height	Contact Height	Qty
004	0.40mm	1.00-1.30	No. of Ways
008	0.80mm	1.40-1.70	

06 Plating Variation
06 = Selective Gold
0.25µm Gold Plated
Contact Nose Pure
Tin Tail

X PCB Location Bosses
1 = With PCB Location Bosses (top side)
2 = Without PCB Location Bosses
3 = With SMT PCB Location Bosses (bottom side)
4 = With SMT and Mating PCB Location Bosses (top and bottom side)



Ultra Low Profile Stacker: BTB

00-9258



0.4MM ULTRA LOW PROFILE STACKER

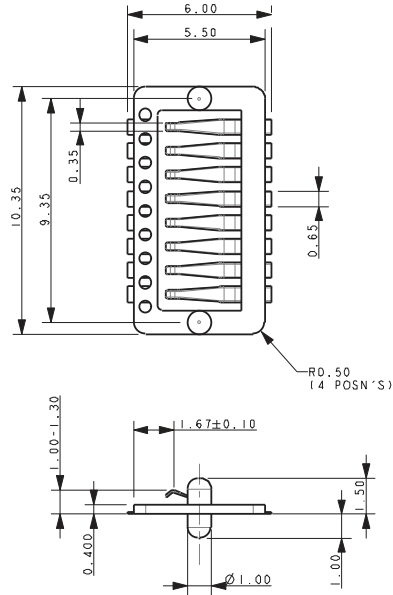

NOTES:

1. 8 WAY ULTRA LOW PROFILE STACKER IN 0.8MM STACK HEIGHT.
2. INSULATOR MATERIAL: NYLON 46 HF5040, 40% GLASS FILLED UL94 V-0. COLOR BLACK.
3. CONTACT MATERIAL; 0.10MM THICK BeCu.
4. CONTACT PLATING: NICKEL UNDERPLATE, SELECTIVE GOLD PLATED CONTACT NOSES PURE TIN PLATED CONTACT SMT TAILS.
5. PARTS TO BE PACKED IN TAPE AND REEL, QTY: 1200.
6. ALL DIMENSIONS FOR REFERENCE UNLESS TOLERANCED.
7. FOR FURTHER INFORMATION REFER TO SPECIFICATION 201-01-115.

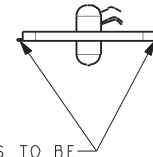
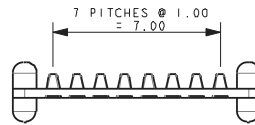

ALL TAILS TO BE WITHIN 0.10 MAX COPLANARITY TOLERANCE

PROPOSED SMT PCB LAYOUT

ALL PADS PURE TIN PLATE

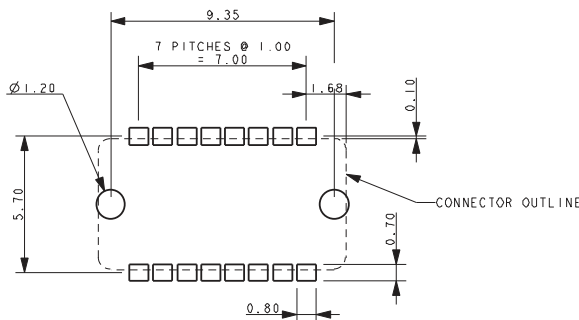

WITH MATING PCB LOCATION BOSSES

(TOP SIDE)

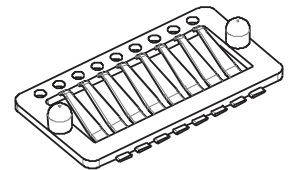

WITHOUT PCB LOCATION BOSSES

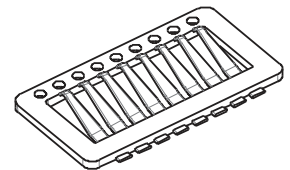

PROPOSED MATING PCB LAYOUT

ALL PADS GOLD PLATE

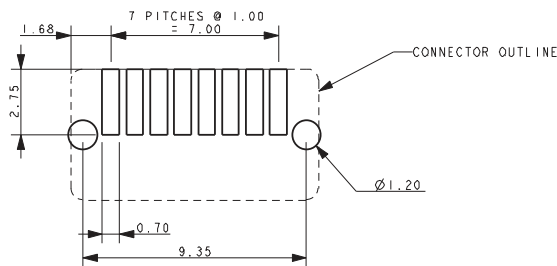

WITH SMT PCB LOCATION BOSSES

(BOTTOM SIDE)

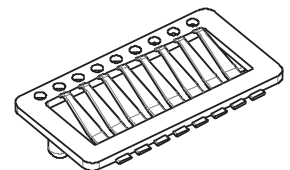

PACKING TAPE DETAILS

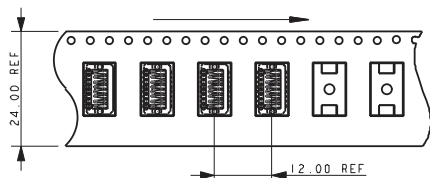

WITH PCB AND SMT LOCATION BOSSES

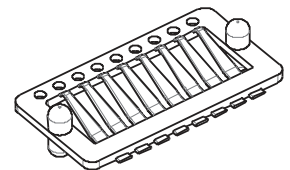

Ultra Low Profile Stacker: BTB

00-9258



0.8MM ULTRA LOW PROFILE STACKER

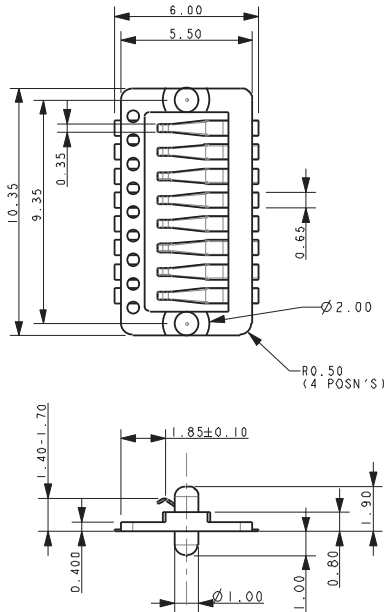

NOTES:

1. 8 WAY ULTRA LOW PROFILE STACKER IN 0.4MM STACK HEIGHT.
2. INSULATOR MATERIAL: NYLON 46 HF5040, 40% GLASS FILLED UL94 V-0. COLOR BLACK.
3. CONTACT MATERIAL; 0.10MM THICK BeCu.
4. CONTACT PLATING: NICKEL UNDERPLATE, SELECTIVE GOLD PLATED CONTACT NOSES PURE TIN PLATED CONTACT SMT TAILS.
5. PARTS TO BE PACKED IN TAPE AND REEL, QTY: 1400.
6. ALL DIMENSIONS FOR REFERENCE UNLESS TOLERANCED.
7. FOR FURTHER INFORMATION REFER TO SPECIFICATION 201-01-115.

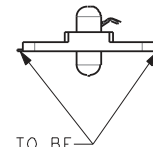
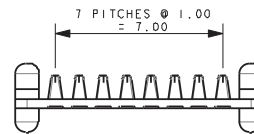

ALL TAILS TO BE WITHIN 0.10 MAX COPLANARITY TOLERANCE

PROPOSED SMT PCB LAYOUT

ALL PADS PURE TIN PLATE

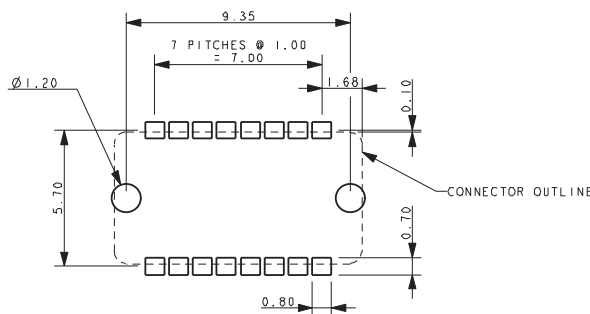

WITH MATING PCB LOCATION BOSSES

(TOP SIDE)

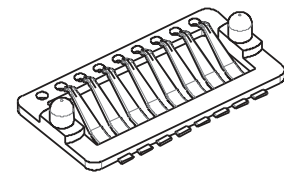

PROPOSED MATING PCB LAYOUT

ALL PADS GOLD PLATE

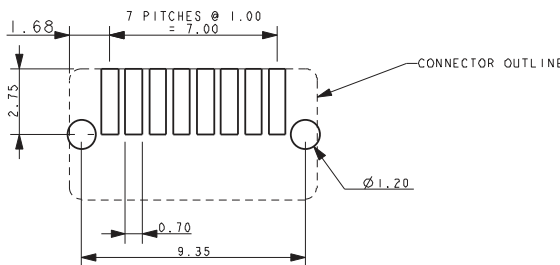

WITHOUT PCB LOCATION BOSSES

WITH SMT PCB LOCATION BOSSES

(BOTTOM SIDE)

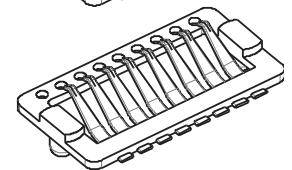
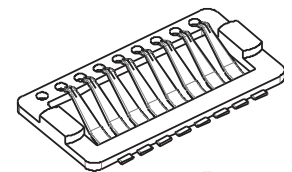

PACKING TAPE DETAILS

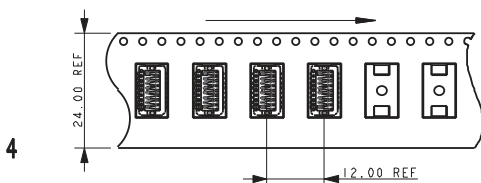

WITH PCB AND SMT LOCATION BOSSES

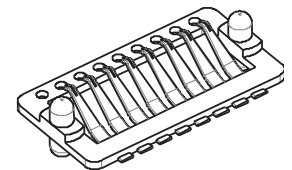

The Important Information/Disclaimer is incorporated in the catalog where these specifications came from or available online at www.avx.com/disclaimer/ by reference and should be reviewed in full before placing any order.