

VERSION FULLY LOADED

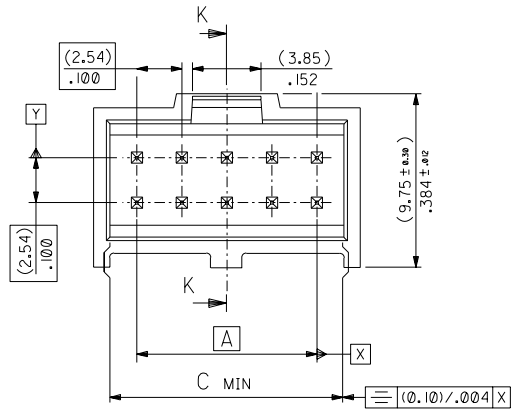

STANDARD VERSION WITH VOIDS

(WHERE VOID POSITIONS ARE NOT SPECIFIED WITH A PART OPTION)

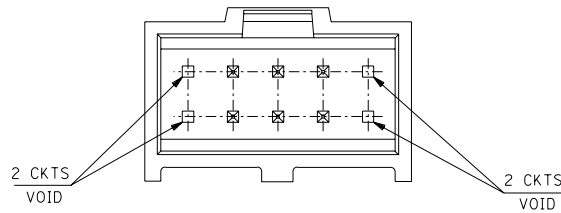

NON-STANDARD VERSION WITH VOIDS

(WHERE VOID POSITIONS ARE SPECIFIED WITH A PART OPTION)

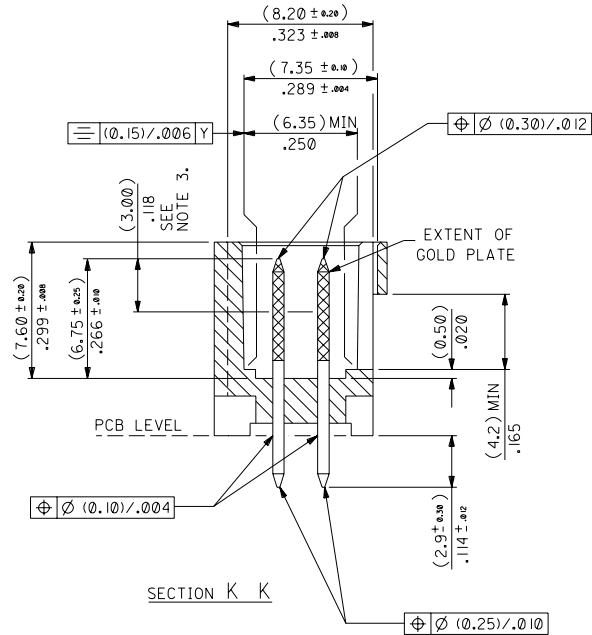
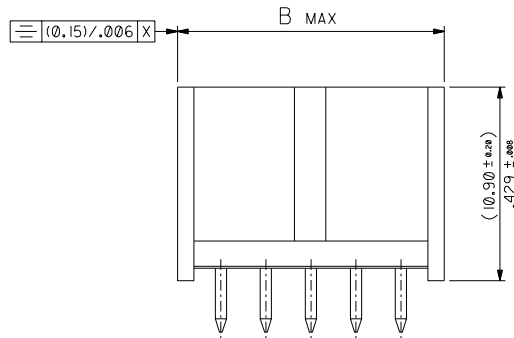
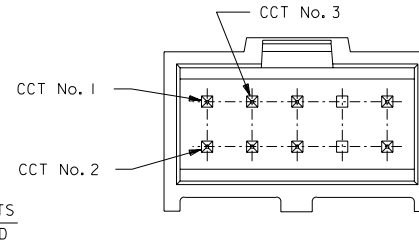

HSG CKT SIZE	A	B	C
6	(5.08) .200	(10.34) .407	(7.92) .312
8	(7.62) .300	(12.88) .507	(10.46) .412
10	(10.16) .400	(15.42) .607	(13.00) .512
12	(12.70) .500	(17.96) .707	(15.54) .612
14	(15.24) .600	(20.50) .807	(18.08) .712
16	(17.78) .700	(23.04) .907	(20.62) .812
18	(20.32) .800	(25.58) 1.007	(23.16) .912
20	(22.86) .900	(28.12) 1.107	(25.70) 1.012
22	(25.40) 1.000	(30.66) 1.207	(28.24) 1.112
24	(27.94) 1.100	(33.20) 1.307	(30.78) 1.212
26	(30.48) 1.200	(35.74) 1.407	(33.32) 1.312
28			
30	(35.56) 1.400	(40.82) 1.607	(38.40) 1.512
32	(38.10) 1.500	(43.36) 1.707	(40.94) 1.612
34	(40.64) 1.600	(45.90) 1.807	(43.48) 1.712
36			
38	(45.72) 1.800	(50.98) 2.007	(48.56) 1.912
40	(48.26) 1.900	(53.52) 2.107	(51.10) 2.012
42			
44	(53.34) 2.100	(58.60) 2.307	(56.18) 2.212
46			
48			
50	(60.96) 2.400	(66.22) 2.607	(63.80) 2.512
52			
54	(66.04) 2.600	(71.30) 2.807	(68.88) 2.712
56			
58	(73.66) 2.900	(78.92) 3.107	(76.50) 3.012
62			
64	(78.74) 3.100	(84.00) 3.307	(81.58) 3.212
66			
68	(83.82) 3.300	(89.08) 3.507	(86.66) 3.412

NOTES

- MATERIAL:-
 - PIN:- (0.635) / .025 SQ. BRASS WIRE.
 - HOUSING:- 15% GLASS FILLED POLYESTER
 - UL 94 V-0 COLOUR BLACK OR NATURAL
- FOR PLATING VERSIONS AND VOID VERSIONS SEE SHEET 2.
- MEASUREMENT POINT FOR MINIMUM PLATING THICKNESS.

RECOMMENDED P.C. BOARD HOLE PATTERN

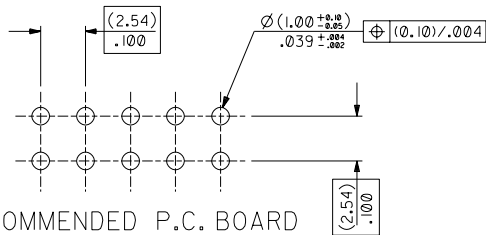

PART NO. SEE CHART
DWG NO. SDA-90130

5	N
4	Q
3	K
2	M
1	S
	SH. REV.

FOR PREVIOUS DRAWING ISSUES SEE MRI.	UPDATE VERSIONS E2004-0428 05/11/2003	REVISIONS	DIMENSIONS SHOWN (METRIC) INCH UNLESS OTHERWISE SPECIFIED TOLERANCES ANGULAR ± ° INCH (METRIC)	DRWG BY KS	REVISE ONLY ON CAD SYSTEM	
	DESIGN DIMENSION	<input type="checkbox"/> (MM)	1 PLACE # ± .004	CHK'D BY	TITLE C - GRID III DUAL ROW STRAIGHT SHROUDED HEADER	
	EQUIVALENT DIMENSION (SECONDARY)	<input type="checkbox"/> (MM)	2 PLACE # ± .010	APP'D BY	SCALE 5:1	SHEET NO. DATE 1 OF 5 23/08/88
	PART NO. SEE CHART			DWG NO. SDA-90130		

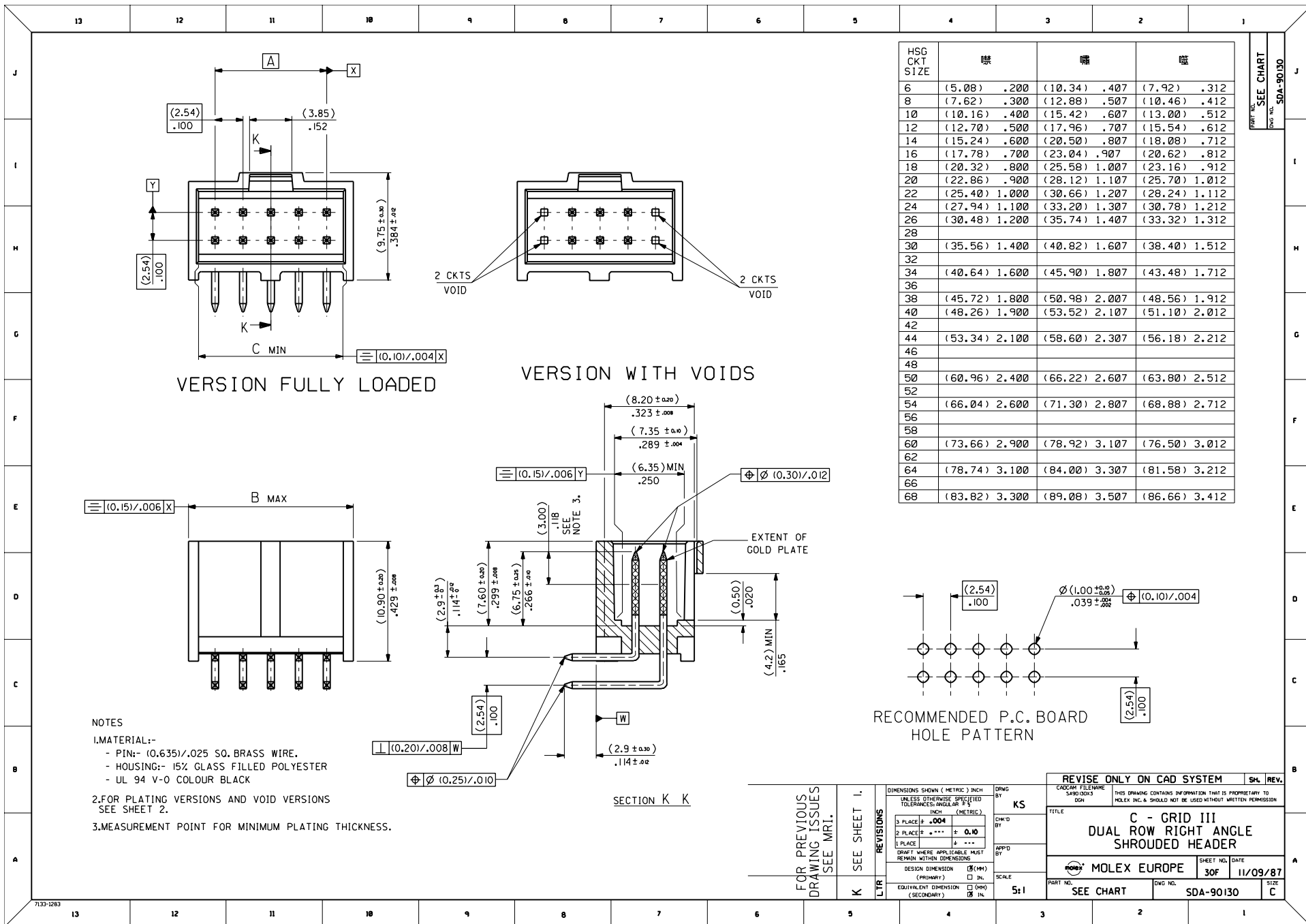

NOTES
 1. MATERIAL:-
 - PIN:- (0.635)/.025 SO. BRASS WIRE.
 - HOUSING:- 15% GLASS FILLED POLYESTER
 - UL 94 V-0 COLOUR BLACK
 2. FOR PLATING VERSIONS AND VOID VERSIONS
 SEE SHEET 2.
 3. MEASUREMENT POINT FOR MINIMUM PLATING THICKNESS.

HSG CKT SIZE	唵		唵		唵	
6	(5.08)	.200	(10.34)	.407	(7.92)	.312
8	(7.62)	.300	(12.88)	.507	(10.46)	.412
10	(10.16)	.400	(15.42)	.607	(13.00)	.512
12	(12.70)	.500	(17.96)	.707	(15.54)	.612
14	(15.24)	.600	(20.50)	.807	(18.08)	.712
16	(17.78)	.700	(23.04)	.907	(20.62)	.812
18	(20.32)	.800	(25.58)	1.007	(23.16)	.912
20	(22.86)	.900	(28.12)	1.107	(25.70)	1.012
22	(25.40)	1.000	(30.66)	1.207	(28.24)	1.112
24	(27.94)	1.100	(33.20)	1.307	(30.78)	1.212
26	(30.48)	1.200	(35.74)	1.407	(33.32)	1.312
28						
30	(35.56)	1.400	(40.82)	1.607	(38.40)	1.512
32						
34	(40.64)	1.600	(45.90)	1.807	(43.48)	1.712
36						
38	(45.72)	1.800	(50.98)	2.007	(48.56)	1.912
40	(48.26)	1.900	(53.52)	2.107	(51.10)	2.012
42						
44	(53.34)	2.100	(58.60)	2.307	(56.18)	2.212
46						
48						
50	(60.96)	2.400	(66.22)	2.607	(63.80)	2.512
52						
54	(66.04)	2.600	(71.30)	2.807	(68.88)	2.712
56						
58						
60	(73.66)	2.900	(78.92)	3.107	(76.50)	3.012
62						
64	(78.74)	3.100	(84.00)	3.307	(81.58)	3.212
66						
68	(83.82)	3.300	(89.08)	3.507	(86.66)	3.412

REF. NO. SEE CHART
 DWG. NO. SDA-90130

FOR PREVIOUS DRAWING ISSUES SEE MRL.

SEE SHEET 1.

REVISIONS

1	PLACE #	.004
2	PLACE #	*** ± 0.10
3	PLACE #	***

DESIGN DIMENSION (PRIMARY) IN. MM
 EQUIVALENT DIMENSION (SECONDARY) IN. MM

DWG. BY: KS
 DATE: 11/09/87
 SCALE: 5:1

REVISE ONLY ON CAD SYSTEM		SHL	REV.

CAD/CAM FILE NAME: S490.DWG
 DGN: DGN

TITLE: C - GRID III DUAL ROW RIGHT ANGLE SHROUDED HEADER

MOLEX EUROPE
 SHEET NO. 30F
 DATE 11/09/87

PART NO. SEE CHART
 DWG. NO. SDA-90130
 SIZE C

NO OF CKTS	HSG CKT SIZE	PART NUMBER		
		PLATING TYPE A	PLATING TYPE E	PLATING TYPE F
		6	6	90130-X106
8	8	X108	X208	X308
10	10	X110	X210	X310
12	12	X112	X212	X312
14	14	X114	X214	X314
16	16	X116	X216	X316
18	18	X118	X218	X318
20	20	X120	X220	X320
22	22	X122	X222	X322
24	24	X124	X224	X324
26	26	X126	X226	X326
28	28			
30	30	X130	X230	X330
32	32			
34	34	X134	X234	X334
36	36			
38	38	X138	X238	X338
40	40	X140	X240	X340
42	42			
44	44	X144	X244	X344
46	46			
48	48			
50	50	X150	X250	X350
52	52			
54	54	X154	X254	X354
56	56			
58	58			
60	60	X160	X260	X360
62	62			
64	64	X164	X264	X364
66	66			
68	68	90130-X168	90130-X268	90130-X368

NO OF CKTS	HSG CKT SIZE	PART NUMBER		
		PLATING TYPE A	PLATING TYPE E	PLATING TYPE F
		2	6	90130-X106
4	8	X108	X208	X308
6	10	X110	X210	X310
8	12	X112	X212	X312
10	14	X114	X214	X314
12	16	X116	X216	X316
14	18	X118	X218	X318
16	20	X120	X220	X320
18	22	X122	X222	X322
20	24	X124	X224	X324
22	26	X126	X226	X326
24	28			
26	30	X130	X230	X330
28	32			
30	34	X134	X234	X334
32	36			
34	38	X138	X238	X338
36	40	X140	X240	X340
38	42			
40	44	X144	X244	X344
42	46			
44	48			
46	50	X150	X250	X350
48	52			
50	54	X154	X254	X354
52	56			
54	58			
56	60	X160	X260	X360
58	62			
60	64	X164	X264	X364
62	66			
64	68	90130-X168	90130-X268	90130-X368

VERSION FULLY LOADED

VERSION WITH VOIDS

NOTES:

- FOR ASSY SEE SHEET 3.
- FOR PLATING DETAILS SEE SDES-99000-0003

90130 - x x x x

INDICATES CIRCUIT HOUSING SIZE

PLATING

- 1 - TYPE A
- 2 - TYPE E
- 3 - TYPE F

STYLE: - RIGHT ANGLE ASSY

- 3 VERSION FULLY LOADED BLACK
- 4 VERSION WITH VOIDS BLACK
- 7. VERSION FULLY LOADED NATURAL
- 8. VERSION WITH VOIDS NATURAL

PART NO. SEE CHART
DWG. NO. SDA-90130

SEE SHEET I	EC NO. DRWN: CHK: APPR:	QUALITY SYMBOLS	GENERAL TOLERANCES: (UNLESS SPECIFIED)	SCALE	DESIGN UNITS	DIMENSIONS:	SHT	REV	
	DESCRIPTION	 MAJOR CRITICAL	mm	INCH	<input checked="" type="checkbox"/> mm <input type="checkbox"/> INCH	<input type="checkbox"/> INCH <input type="checkbox"/> mm <input type="checkbox"/> mm ONLY	THIRD ANGLE PROJECTION	REVISE ON CAD ONLY	
			4 PLACES ±0. ±.	3 PLACES ±0. ±.	DRAWN BY & DATE	TITLE: C - GRID III DUAL ROW RIGHT ANGLE SHROUDED HEADER			
			2 PLACES ±0. ±.	1 PLACE ±0. ±.	KS 10/09/87				
ANGULAR: ± °		CHECKED BY & DATE	10/09/87						
REV			DRAFT WHERE APPLICABLE MUST REMAIN WITHIN DIMENSIONS	APPROVED BY & DATE	CAD FILENAME	MATERIAL NO. SEE CHART	DRAWING NO. SDA-90130	SHEET NO. 4 OF 5	
				THIS DRAWING CONTAINS INFORMATION THAT IS PROPRIETARY TO MOLEX INCORPORATED AND SHOULD NOT BE USED WITHOUT WRITTEN PERMISSION.				SIZE C	