

CMSBN6601-HF

Dual N-Channel

RoHS Device

Halogen Free

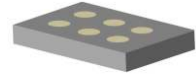

Features

- It is ESD protected.
- This device is suitable for use as a unidirectional or bi-directional load switch, facilitated by its common-drain configuration.

Mechanical data

- Case: CSPB2718-6, standard package, molded plastic.

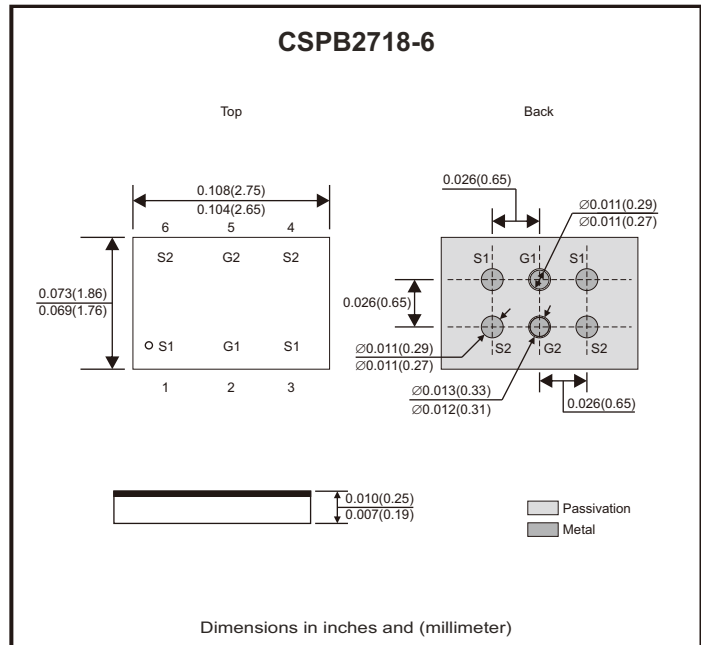

Circuit diagram

- G : Gate
- S : Source

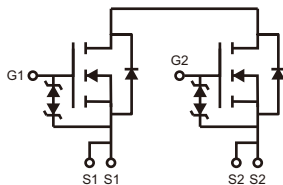

Maximum Ratings (at TA=25°C unless otherwise noted)

Parameter	Symbol	Value	Unit
Source to source voltage	V _{SSS}	20	V
Gate-source voltage	V _{GSS}	±12	V
Source current DC (Note 1)	I _S	13	A
Source current pulse (Note 1, 2)	I _{SP}	60	A
Total dissipation (Note 1)	P _T	2.0	W
Channel temperature	T _{ch}	150	°C
Storage temperature range	T _{STG}	-55 to +150	

Notes: 1. Mounted on FR4 board (25.4mm x 25.4mm x t1.0mm) using the minimum recommended pad size (36µm copper).

2. t = 10µs, duty cycle ≤ 1 %

Electrical Characteristics (at $T_A=25^\circ\text{C}$ unless otherwise noted)

Parameter	Symbol	Conditions	Min	Typ	Max	Unit
Static parameters						
Source to source breakdown voltage	BV_{SSS}	$I_S = 1\text{mA}, V_{GS} = 0\text{V}$,	20			V
Zero-gate voltage source current	I_{SSS}	$V_{SS} = 20\text{V}, V_{GS} = 0\text{V}$			1	μA
Gate to source leakage current	I_{GSS}	$V_{SS} = 0\text{V}, V_{GS} = \pm 8\text{V}$			± 1	μA
Cutoff voltage	$V_{GS(\text{off})}$	$V_{SS} = 10\text{V}, I_S = 1\text{mA}$	0.5	0.8	1.3	V
Forward transfer admittance	$ y_{gfs} $	$V_{SS} = 10\text{V}, I_S = 3\text{A}$	6.5			S
Static source to source on-resistance	$R_{SS(\text{on})}$	$V_{GS} = 4.5\text{V}, I_S = 3\text{A}$		8	11.5	m Ω
		$V_{GS} = 4.0\text{V}, I_S = 3\text{A}$		8.3	12	
		$V_{GS} = 3.8\text{V}, I_S = 3\text{A}$		8.5	13	
		$V_{GS} = 3.1\text{V}, I_S = 3\text{A}$		8.8	15	
		$V_{GS} = 2.5\text{V}, I_S = 3\text{A}$		9.9	17	
Turn-on delay time	$t_{d(\text{on})}$	$V_{SS} = 10\text{V}, I_S = 3\text{A}, V_{GS} = 4.5\text{V}$		1.5		μS
Turn-on rise time	t_r			5		
Turn-off delay time	$t_{d(\text{off})}$			40		
Turn-off fall time	t_f			55		
Total gate charge	Q_g	$V_{SS} = 10\text{V}, I_S = 6\text{A}, V_{GS} = 4.5\text{V}$		25.4		nC
Diode forward voltage	$V_{F(S-S)}$	$V_{GS} = 0\text{V}, I_S = 6\text{A}$		0.9	1.2	V

Rating and Characteristic Curves (CMSBN6601-HF)

Fig.1 - Output Characteristics

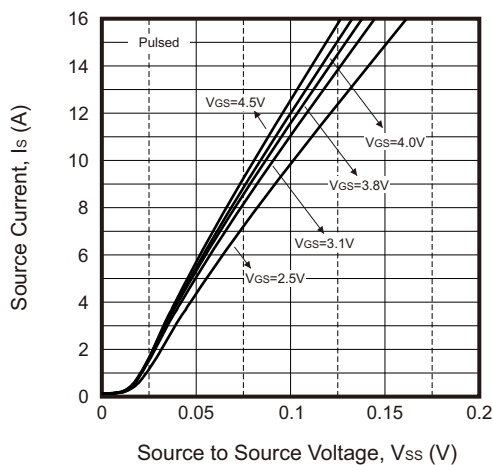
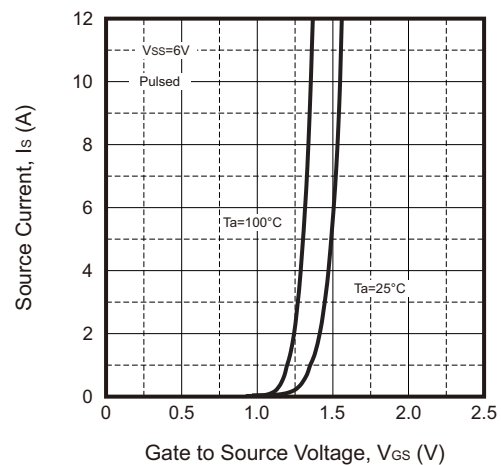

Fig.2 - $I_S - V_{GS}$



Rating and Characteristic Curves (CMSBN6601-HF)

Fig.3 - $R_{SS(ON)} - I_s$

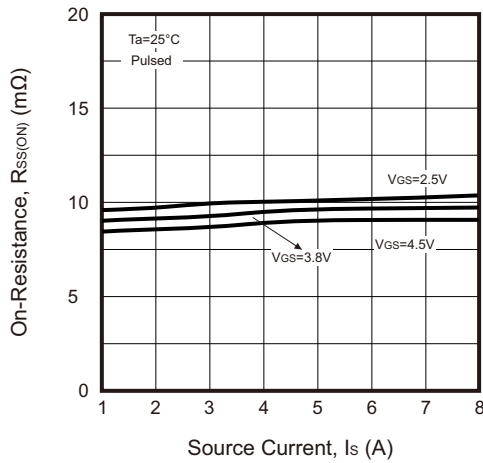

Fig.4 - $R_{SS(ON)} - V_{GS}$

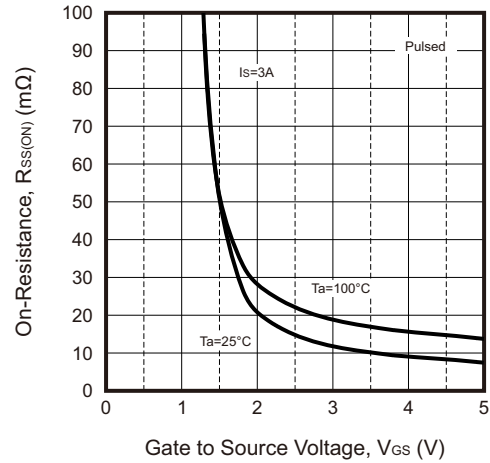

Fig.5 - $I_s - V_{SS}$

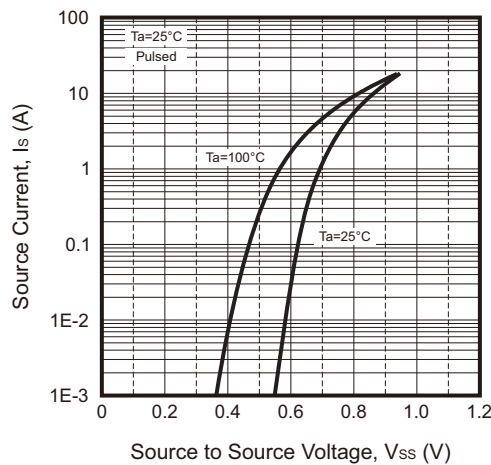

Fig.6 - Threshold Voltage

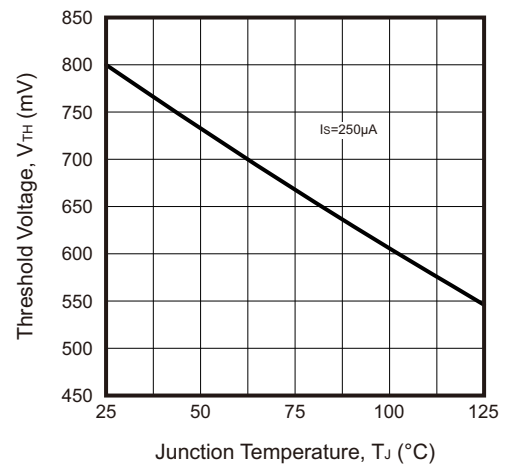

Fig.7 - Total Power Dissipation vs. Ambient Temperature

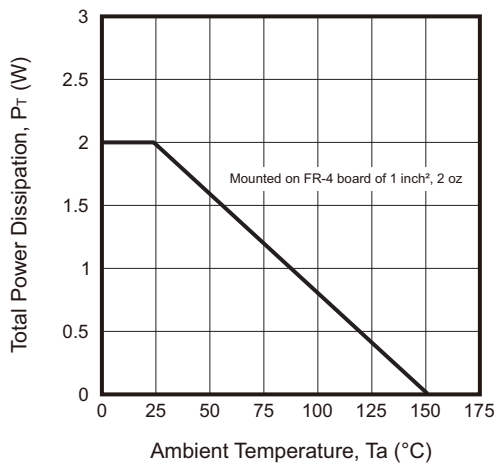
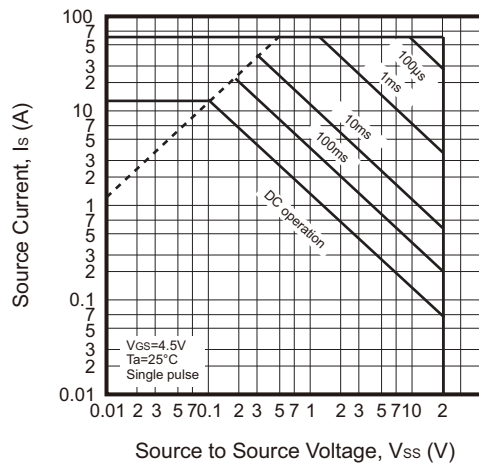
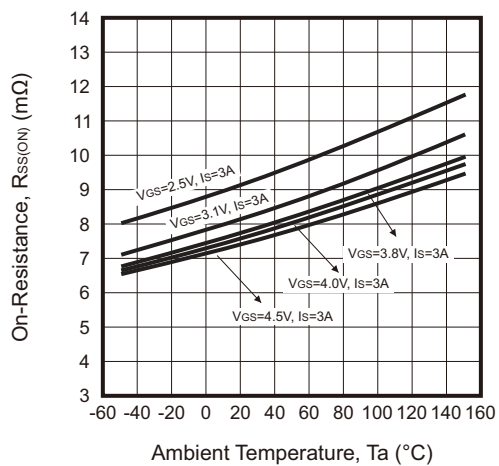

Fig.8 - Maximum Safe Operating Area



Rating and Characteristic Curves (CMSBN6601-HF)

Fig.9 - $R_{SS(ON)} - T_a$



Reel Taping Specification

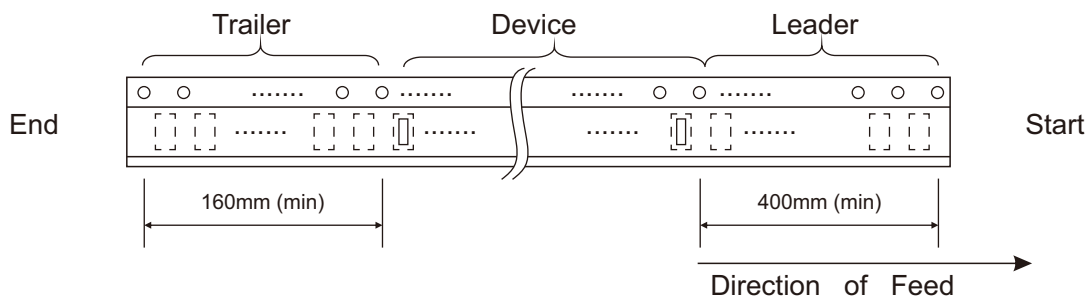
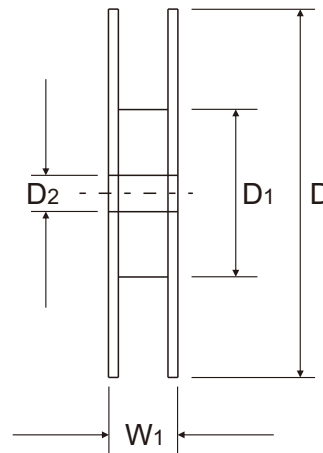
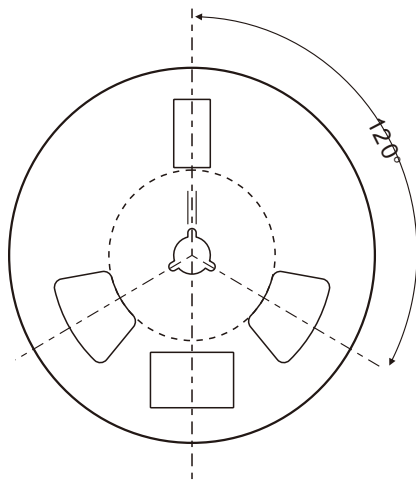
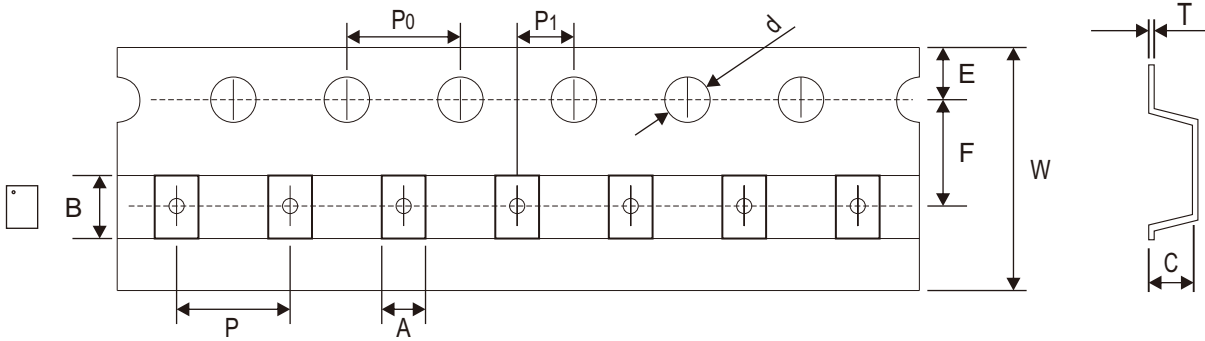

	SYMBOL	A	B	C	d	D	D1	D2
CSPB2718-6	(mm)	1.95 ± 0.05	2.90 ± 0.05	0.30 ± 0.05	$1.50 + 0.10$	180.00 Typ	60.00 Typ	13.00 Typ
	(inch)	0.077 ± 0.002	0.114 ± 0.002	0.012 ± 0.002	$0.059 + 0.004$	7.087 Typ	2.362 Typ	0.512 Typ

	SYMBOL	E	F	P	P0	P1	T	W	W1
CSPB2718-6	(mm)	1.75 ± 0.10	3.50 ± 0.05	4.00 Typ	4.00 Typ	2.00 ± 0.05	0.20 ± 0.02	$8.00 + 0.30$ $- 0.10$	11.40 Typ
	(inch)	0.069 ± 0.004	0.138 ± 0.002	0.157 Typ	0.157 Typ	0.079 ± 0.002	0.008 ± 0.001	$0.315 + 0.012$ $- 0.004$	0.449 Typ

Company reserves the right to improve product design, functions and reliability without notice. REV:A

Marking Code

Part Number	Marking Code
CMSBN6601-HF	C 6601



XXXX = Control code

Suggested PAD Layout

SIZE	CSPB2718-6	
	(mm)	(inch)
A	0.65	0.026
B	0.65	0.026
C	0.30	0.012

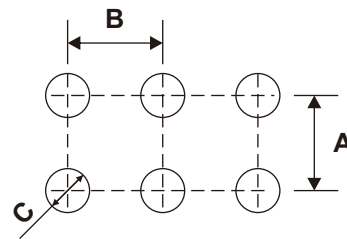

Note: 1. The pad layout is for reference purposes only.

Standard Packaging

Case Type	REEL PACK	
	REEL (pcs)	Reel Size (inch)
CSPB2718-6	3000	7