

Dimensions mm[inch]

tolerances according to DIN ISO 2768-m
Toleranzen gem. DIN ISO 2768-m

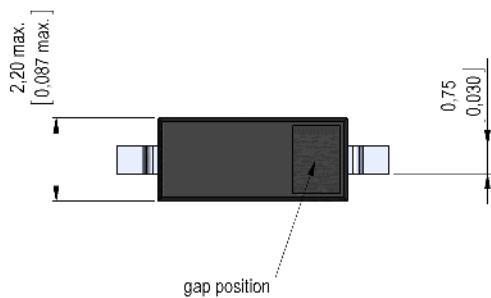
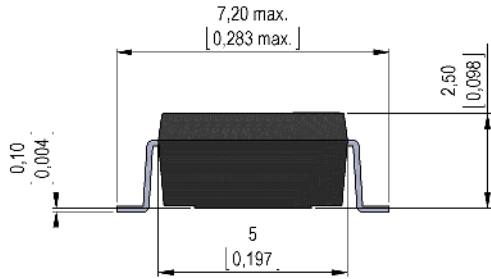

Isometric

Scale 5:1
Maßstab 5:1

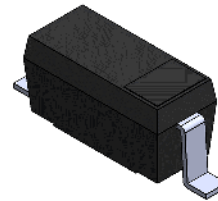

Recommended PCB Pad Layout

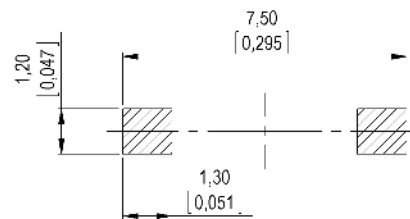

Solder Reflow Profile

reflow soldering conditions according to JEDEC norm J-STD 020D.1

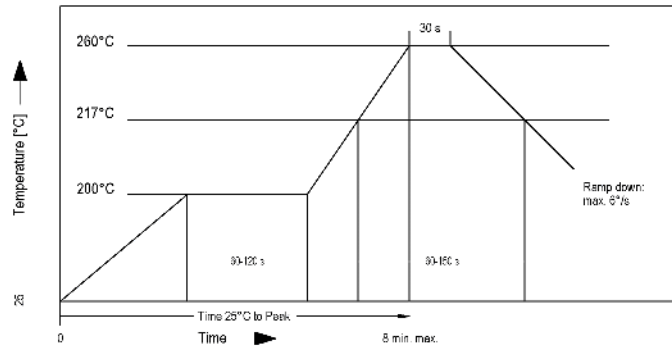

Notes:

Min. distance magnet to sensor: 1,0mm
Mindestabstand Magnet zu Sensor: 1,0mm

In case of direct contact with the magnet, the sensor can change his sensitivity!
Direkte Berührung mit dem Betätigungsmagnet kann die Empfindlichkeit verändern!

The north-pole of the magnet is on the side of the gap position.
Der Nordpol des Magneten ist der Seite der Spaltposition.

Packaging

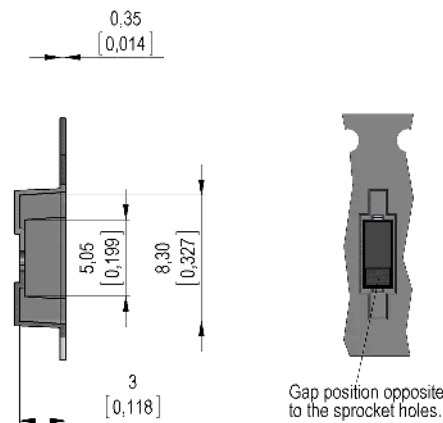
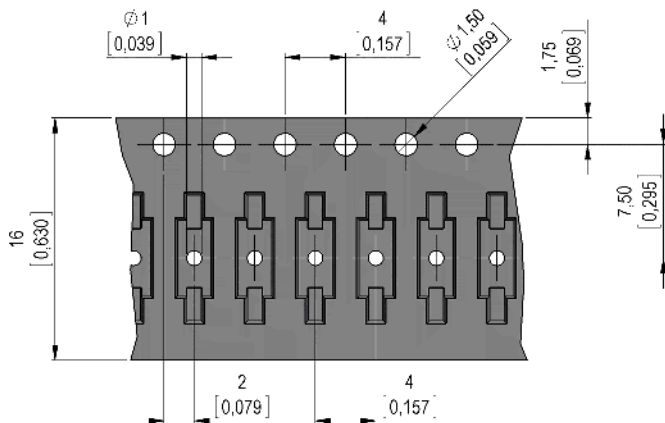

Gap position opposite to the sprocket holes.



Europe: +49 / 7731 8399 0

| Email: info@standexmeder.com

Item No.:

USA: +1 / 508 295 0771

| Email: salesusa@standexmeder.com

9240100021

Asia: +852 / 2955 1682

| Email: salesasia@standexmeder.com

Item:

MK24-B-2-OE

Magnetic properties	Conditions	Min	Typ	Max	Unit
Pull-In	at 20°C	20		40	AT
Drop out	at 20°C	10		35	AT
Test equipment		KMS-11 + AP74			
Pull-In in milliTesla (modified conta	MS150 - phys. caused tolerance +/- 0,1mT	1,4		3,3	mT
Test equipment		MS-150			

Contact data 04	Conditions	Min	Typ	Max	Unit
Contact - No.		04			
Contact-form		B - NC			
		Ruthenium			
Contact rating (> 9 AT)	Any DC combination of V & A not to exceed their individual max.'s			3	W
Switching voltage	DC or Peak AC			30	V
Switching current (> 9 AT)	DC or Peak AC			0,3	A
Carry current (> 9 AT)	DC or Peak AC			0,5	A
Contact resistance static (>9AT)	Measured with 40% overdrive Start value			200	mOhm
Insulation resistance	RH <45 %, 100 V test voltage	10			GOhm
Breakdown voltage (> 9 AT)	according to IEC 255-5	100			VDC

Special Product Data	Conditions	Min	Typ	Max	Unit
Housing material		mineral-filled epoxy			

Environmental data	Conditions	Min	Typ	Max	Unit
Shock	1/2 sine wave duration 11ms			30	g
Vibration	from 10 - 2000 Hz			20	g
Remark		Pick & place force should not exceed 25cN!			
Operating temperature		-40		115	°C
Storage temperature		-50		115	°C
Washability		fully sealed			
Remark		no direct touch between sensor and strong magnets!			

General data	Conditions	Min	Typ	Max	Unit
Packaging		T&R per 500 pcs.			

Modifications in the sense of technical progress are reserved

Designed at: 15.03.10 Designed by: THAUKE

Approval at: 27.01.11 Approval by: DKUECHLER

Last Change at: 03.05.17 Last Change by: WKOVACS

Approval at: 04.05.17 Approval by: MREIZNER

Rev. No.: 07