

LOC		DIST		REVISIONS			
AD	00	REV	DATE	BY	CHKD	APVD	
A		REVISED PER EC OS12-0306-05	01FEB06	BC	GS		
B		ECR-10-019054	15SEP10	DP	MQW		

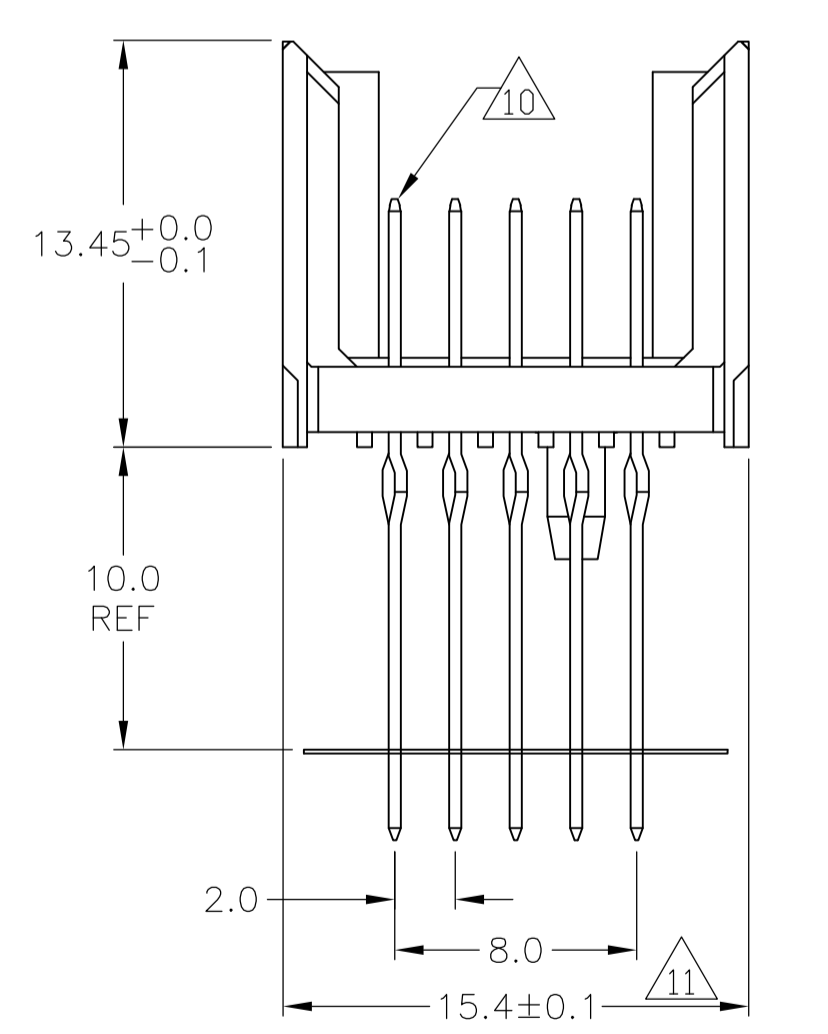

CONTACT DIMENSIONS

SCALE 5:1

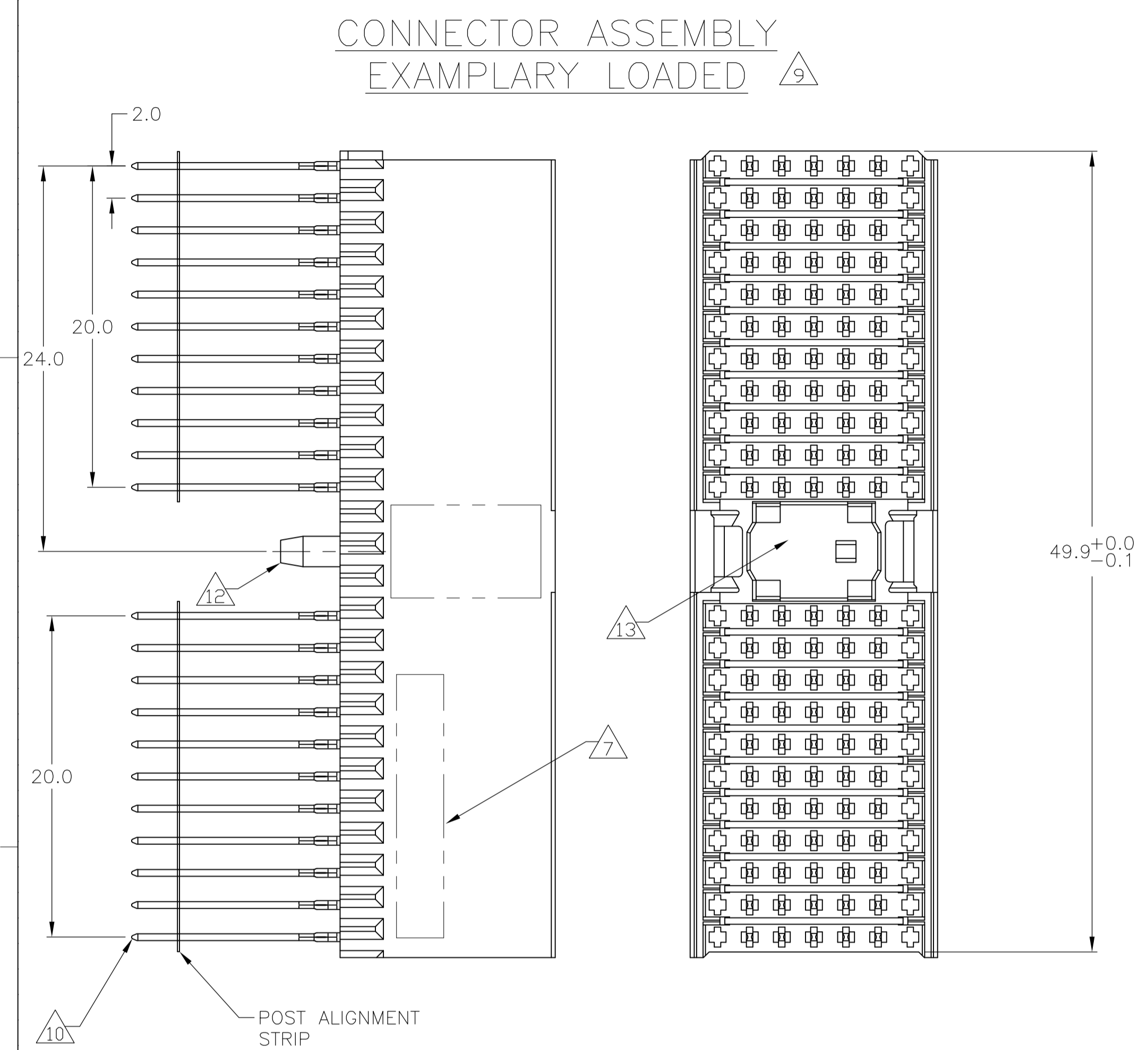
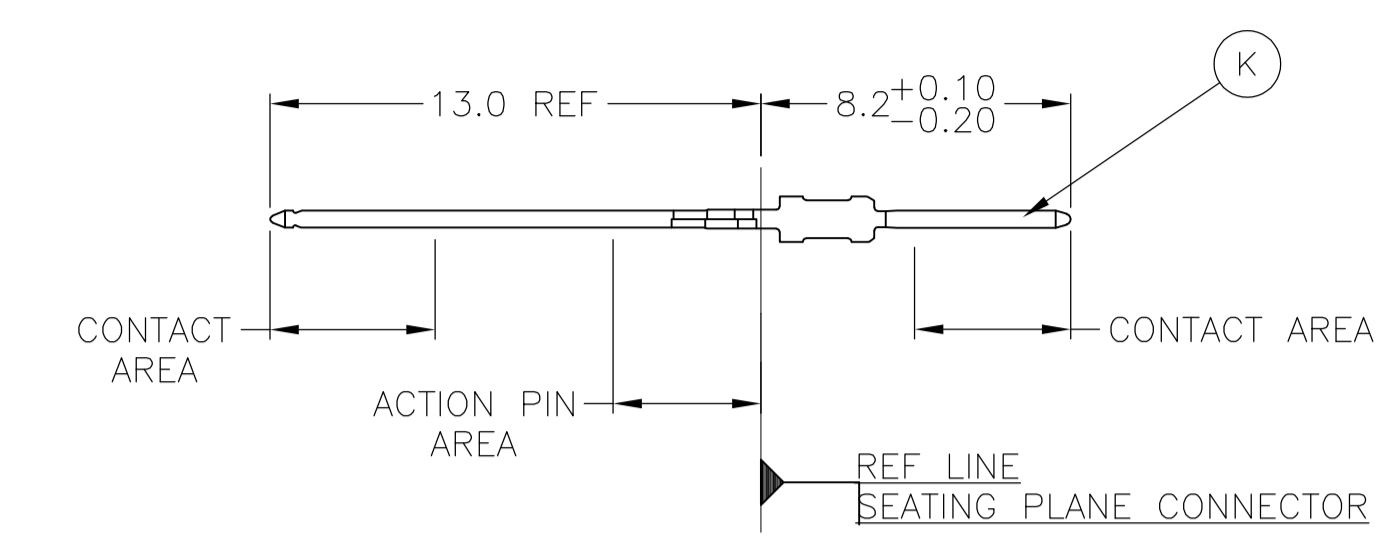

CONTACT LAYOUT

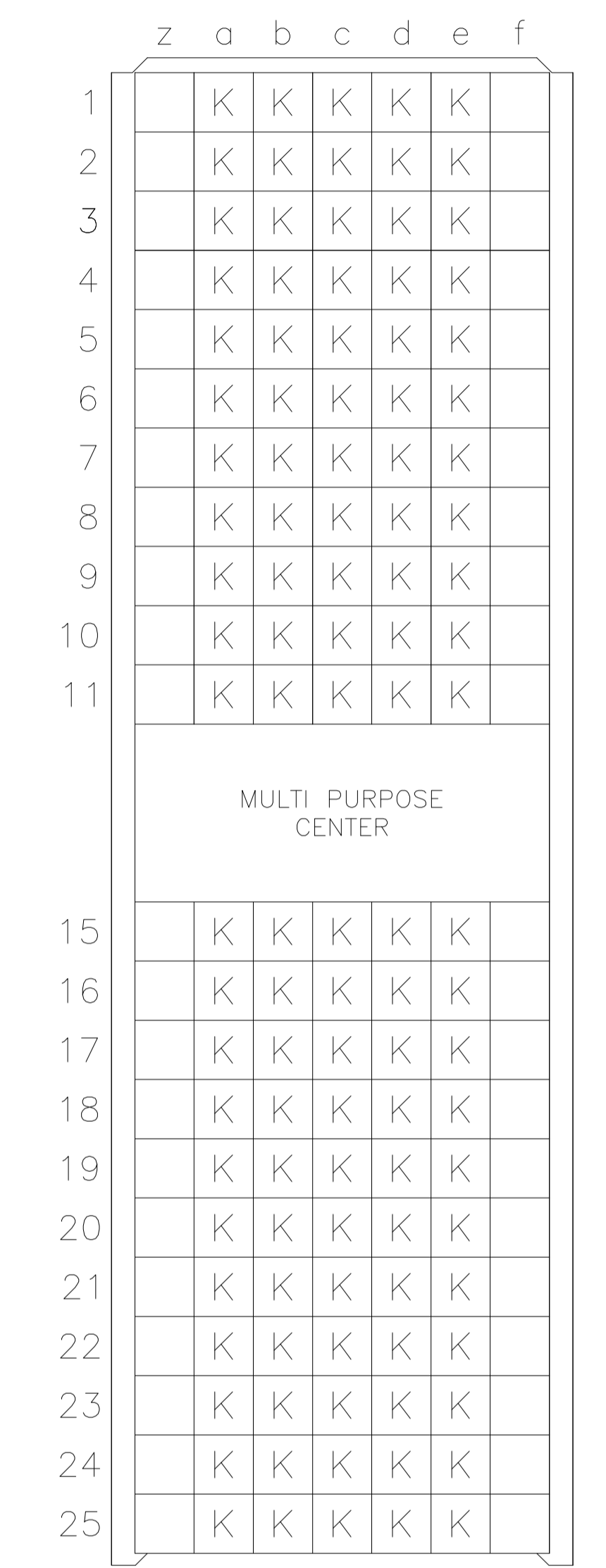

RECOMMENDED PCB-HOLE LAYOUT COMPONENT SIDE SHOWN

PLATED THRU HOLES PARAMETERS

REFERENCE APPLICATION SPECIFICATION

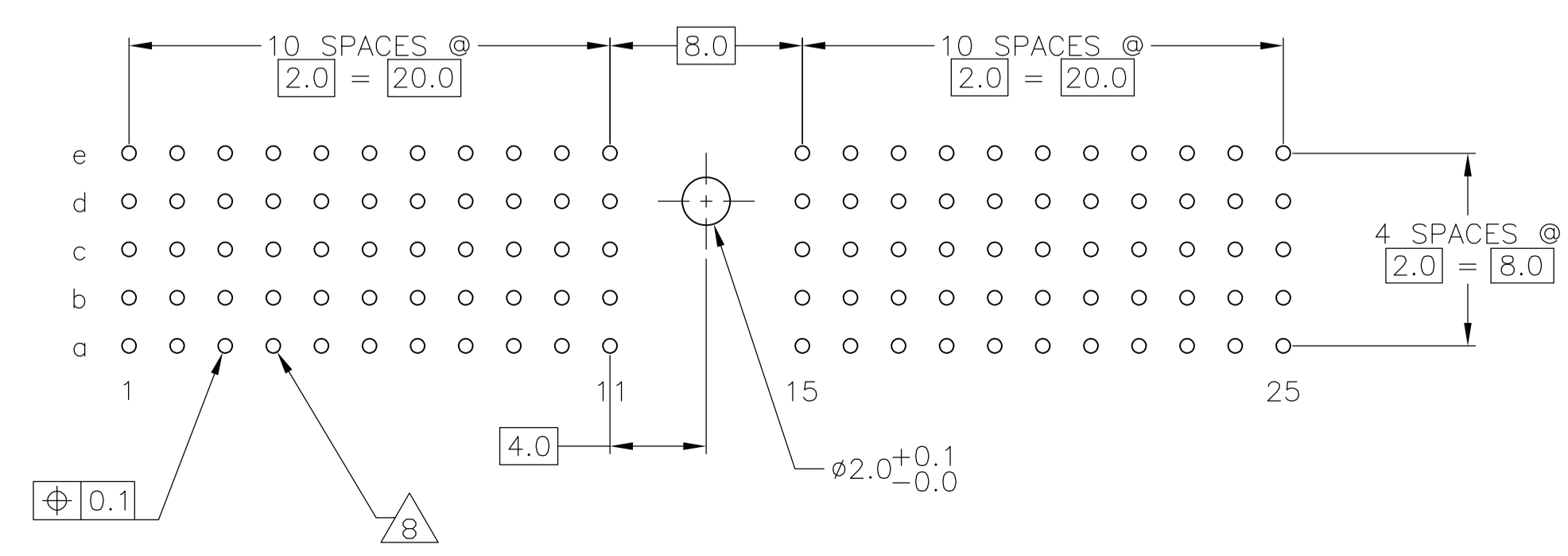

2 6 14	1-5106164-9
2 5 14	5106164-9
2 4	5106164-4
2 3	5106164-1
FINISH	PART NUMBER

THIS DRAWING IS A CONTROLLED DOCUMENT.

DIMENSIONS: mm	TOLERANCES UNLESS OTHERWISE SPECIFIED: ±0.2	DIN B CARBO 24JAN05	Tyco Electronics Corporation Harrisburg, Pa 17105-3608
0-PLG ±	1-PLG ±0.1	CHK G SKIPPER 24JAN05	MALE ASSEMBLY, Z-PACK 2mm HM, TYPE A
2-PLG ±	3-PLG ±	APVD G SKIPPER 24JAN05	108-19082
4-PLG ±	ANGLES ±	PRODUCT SPEC	114-19029
MATERIAL 1	FINISH SEE TABLE	SIZE A1	00779 C=5106164
		WEIGHT	RESTRICTED TO
		CUSTOMER DRAWING	SCALE 4:1 SHEET 1 OF 2 REV B

LOC	DIST	REVISIONS			
P	LTR	DESCRIPTION	DATE	DN	APVO
AD	00	SEE SHEET 1	-	-	-

- 1 MATERIAL:
CONTACT: PHOSPHOR BRONZE.
HOUSING: GLASS-FILLED POLYESTER.
- 2 GENERAL PLATING SPECIFICATION: UNDERPLATING
(ENTIRE CONTACT): 1.27µm MIN NICKEL AND ACTION
PIN: 0.5µm MIN TIN.
FOR PLATING OF MATING SURFACES SEE APPLICABLE
SPECIFICATION REFERENCE FOR EACH DASH NUMBER.
- 3 CONFORMS TO ALL TESTING ACCORDING TO IEC 61076-4-101
PERFORMANCE LEVEL 2.
- 4 CONFORMS TO ALL TESTING ACCORDING TO IEC 61076-4-101
PERFORMANCE LEVEL 1.
- 5 CONNECTOR TESTED AND QUALIFIED AGAINST TELCORDIA GR-1217-CORE QUALITY LEVEL 3,
CENTRAL OFFICE APPLICATIONS.
- 6 CONNECTOR TESTED AND QUALIFIED AGAINST TELCORDIA GR-1217-CORE QUALITY LEVEL 3,
UNCONTROLLED ENVIROMENT APPLICATIONS.
- 7 CONNECTOR MARKED WITH PART NUMBER AND DATE CODE.
ADDITIONAL CHARACTERS OR MARKINGS, AS WELL AS THE LOCATION OF THE MARKINGS,
MAY BE ADDED FOR TRACEABILITY BASED UPON MANUFACTURERS DISCRETION.
- 8 PLATED-THROUGH HOLES AT 2x2mm SQUARE GRID
PATTERN DEFINED BY CONTACT LAYOUT.
- 9 FOR ACTUAL PIN LOADING SEE "CONTACT LAYOUT".
- 10 FOR ACTUAL PIN DIMENSIONS SEE "CONTACT DIMENSIONS".
- 11 TO BE MEASURED AT BOTTOM OF SHROUD.
- 12 POLARIZATION FEATURE.
- 13 AREA RESERVED FOR KEYING PART (BASIC P/N 100525)
- 14 CONNECTOR LUBRICATED WITH BELCORE APPROVED LUBRICANT,
TECHNICAL REFERENCE: TR-NWT-001217 ISSUE 1, SEP 1992.

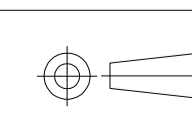
THIS DRAWING IS A CONTROLLED DOCUMENT.		DIN B CARBO	24JAN05	 Tyco Electronics Corporation Harrisburg, Pa 17105-3608
		CIK G SKIPPER	24JAN05	
DIMENSIONS: mm		TOLERANCES UNLESS OTHERWISE SPECIFIED: 0-PLC ± 1-PLC ± 0.1 2-PLC ± 3-PLC ± 4-PLC ± ANGLES ±		APVO G SKIPPER 24JAN05 NAME MALE ASSEMBLY, Z-PACK 2mm HM, TYPE A
		PRODUCT SPEC 108-19082 APPLICATION SPEC 114-19029		SIZE A1 CAGE CODE 00779 DRAWING NO 5106164 RESTRICTED TO -
MATERIAL SEE SHEET 1	FINISH SEE SHEET 1	WEIGHT -	CUSTOMER DRAWING	SCALE 4:1 SHEET 2 OF 2 REV B