



FGA180N30D

300V PDP IGBT

Features

- High Current Capability
- Low saturation voltage: $V_{CE(sat)}$, Typ = 1.1 V@ $I_C = 40A$
- High Input Impedance

Description

Employing Unified IGBT Technology, FGA180N30D provides low conduction and switching loss. FGA180N30D offers the optimum solution for PDP applications where low conduction loss is essential.

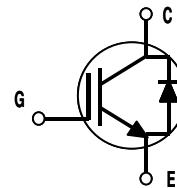
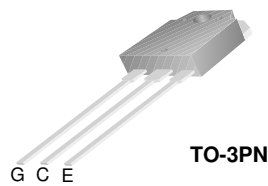

Absolute Maximum Rating TC = 25oC unless otherwise noted

Symbol	Description	FGA180N30D	Units
V_{CES}	Collector-Emitter Voltage	300	V
V_{GES}	Gate-Emitter Voltage	± 30	V
I_C	Collector Current @ $T_C = 25^\circ C$	180	A
I_{CM}	Pulsed Collector Current (Note 1) @ $T_C = 25^\circ C$	450	A
I_F	Diode Continuous Forward Current @ $T_C = 100^\circ C$	10	A
I_{FM}	Diode Maximum Forward Current	40	A
P_D	Maximum Power Dissipation @ $T_C = 25^\circ C$	480	W
	Maximum Power Dissipation @ $T_C = 100^\circ C$	192	W
T_J	Operating Junction Temperature	-55 to +150	°C
T_{stg}	Storage Temperature Range	300	°C
T_L	Maximum Lead Temp. for soldering Purposes, 1/8" from case for 5 seconds	300	°C

Notes:

(1) Repetitive test , pulse width = 100usec , Duty = 0.2

* I_{c_pulse} limited by max T_j

Thermal Characteristics

Symbol	Parameter	Typ.	Max.	Units
$R_{\theta JC}$	Thermal Resistance, Junction-to-Case for IGBT	--	0.26	°C/W
$R_{\theta JC}$	Thermal Resistance, Junction-to-Case for Diode	--	1.56	°C/W
$R_{\theta JA}$	Thermal Resistance, Junction-to-Ambient	--	40	°C/W

Package Marking and Ordering Information

Device Marking	Device	Package	Reel Size	Tape Width	Quantity
FGA180N30D	FGA180N30D	TO-3PN	--	--	30

Electrical Characteristics of the IGBT $T_C = 25^\circ\text{C}$ unless otherwise noted

Symbol	Parameter	Test Conditions	Min.	Typ.	Max.	Units
Off Characteristics						
BV_{CES}	Collector-Emitter Breakdown Voltage	$V_{GE} = 0V, I_C = 250\mu A$	300	--	--	V
$\Delta BV_{CES}/\Delta T_J$	Temperature Coefficient of Breakdown Voltage	$V_{GE} = 0V, I_C = 250\mu A$	--	0.6	--	$V/^\circ\text{C}$
I_{CES}	Collector Cut-Off Current	$V_{CE} = V_{CES}, V_{GE} = 0V$	--	--	100	μA
I_{GES}	G-E Leakage Current	$V_{GE} = V_{GES}, V_{CE} = 0V$	--	--	± 250	nA
On Characteristics						
$V_{GE(th)}$	G-E Threshold Voltage	$I_C = 250\mu A, V_{CE} = V_{GE}$	2.5	4.0	5.0	V
$V_{CE(sat)}$	Collector to Emitter Saturation Voltage	$I_C = 40A, V_{GE} = 15V$	--	1.1	1.4	V
		$I_C = 180A, V_{GE} = 15V, T_C = 25^\circ\text{C}$	--	1.9	--	V
		$I_C = 180A, V_{GE} = 15V, T_C = 125^\circ\text{C}$	--	2.0	--	V
Dynamic Characteristics						
C_{ies}	Input Capacitance	$V_{CE} = 30V, V_{GE} = 0V, f = 1\text{MHz}$	--	3420	--	pF
C_{oes}	Output Capacitance		--	520	--	pF
C_{res}	Reverse Transfer Capacitance		--	150	--	pF
Switching Characteristics						
$t_{d(on)}$	Turn-On Delay Time	$V_{CC} = 200V, I_C = 40A, R_G = 5\Omega, V_{GE} = 15V, \text{Resistive Load}, T_C = 25^\circ\text{C}$	--	30	--	ns
t_r	Rise Time		--	210	--	ns
$t_{d(off)}$	Turn-Off Delay Time		--	100	--	ns
t_f	Fall Time		--	140	300	ns
E_{on}	Turn-On Switching Loss		--	0.26	--	mJ
E_{off}	Turn-Off Switching Loss		--	0.75	--	mJ
E_{ts}	Total Switching Loss		--	1.01	--	mJ
$t_{d(on)}$	Turn-On Delay Time	$V_{CC} = 200V, I_C = 40A, R_G = 5\Omega, V_{GE} = 15V, \text{Resistive Load}, T_C = 125^\circ\text{C}$	--	30	--	ns
t_r	Rise Time		--	230	--	ns
$t_{d(off)}$	Turn-Off Delay Time		--	110	--	ns
t_f	Fall Time		--	220	--	ns
E_{on}	Turn-On Switching Loss		--	0.27	--	mJ
E_{off}	Turn-Off Switching Loss		--	1.0	--	mJ
E_{ts}	Total Switching Loss		--	1.27	--	mJ
Q_g	Total Gate Charge	$V_{CE} = 200V, I_C = 40A, V_{GE} = 15V$	--	185	277	nC
Q_{ge}	Gate-Emitter Charge		--	24	36	nC
Q_{gc}	Gate-Collector Charge		--	88	132	nC

Electrical Characteristics of DIODE $T_C = 25^\circ\text{C}$ unless otherwise noted

Symbol	Parameter	Test Conditions	Min.	Typ.	Max.	Units	
V_{FM}	Diode Forward Voltage	$I_F = 10\text{A}$	$T_C = 25^\circ\text{C}$	--	1.1	1.4	V
			$T_C = 125^\circ\text{C}$	--	0.9	--	
t_{rr}	Diode Reverse Recovery Time	$I_F = 10\text{A}$ $di/dt = 200\text{A}/\mu\text{s}$	$T_C = 25^\circ\text{C}$	--	21	--	ns
			$T_C = 125^\circ\text{C}$	--	35	--	
I_{rr}	Diode Peak Reverse Recovery Current		$T_C = 25^\circ\text{C}$	--	2.8	--	A
			$T_C = 125^\circ\text{C}$	--	5.6	--	
Q_{rr}	Diode Reverse Recovery Charge		$T_C = 25^\circ\text{C}$	--	29.4	--	nC
			$T_C = 125^\circ\text{C}$	--	98	--	

Typical Performance Characteristics Typical Saturation Voltage Characteristics

Figure 1. Typical Output Characteristics

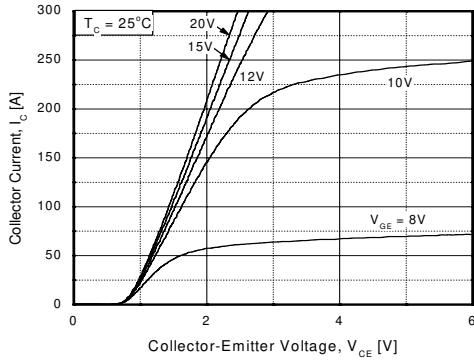

Figure 2. Typical Output Characteristics

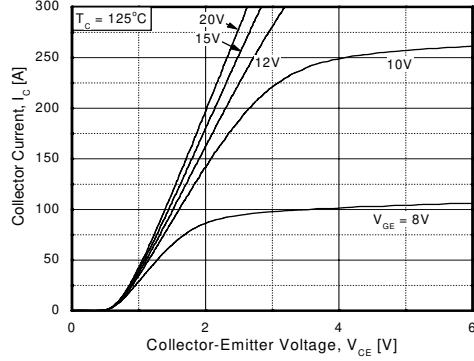

Figure 3. Saturation Voltage

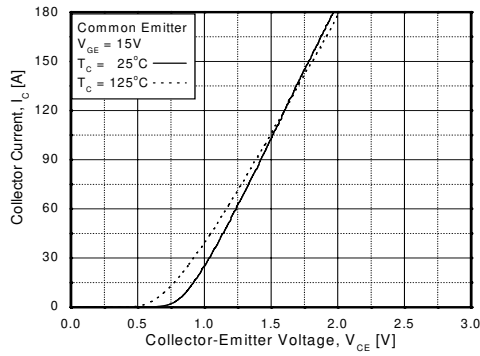

Figure 4. Transfer Characteristics

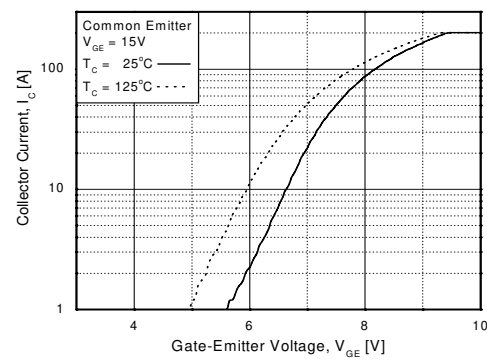

Figure 5. Saturation Voltage vs. Case Temperature at Variant Current Level

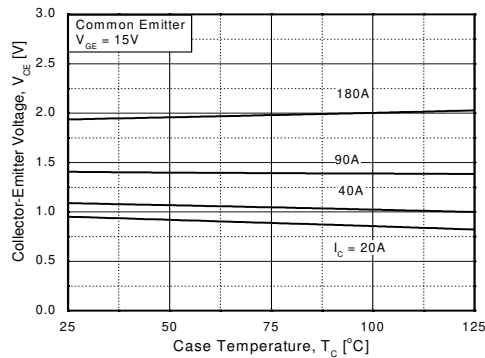
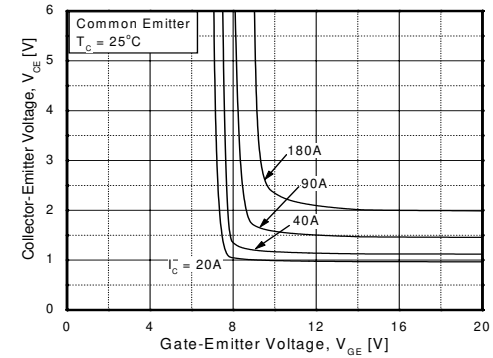

Figure 6. Saturation Voltage vs. V_{GE}



Typical Performance Characteristics (Continued)

Figure 7. Saturation Voltage vs. V_{GE}

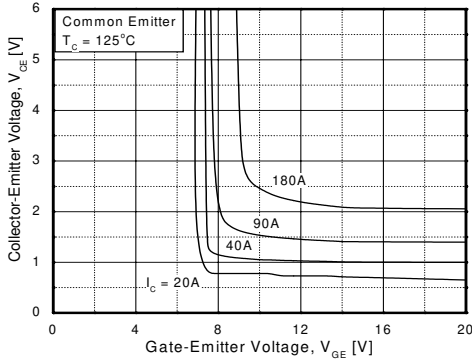

Figure 8. Capacitance Characteristics

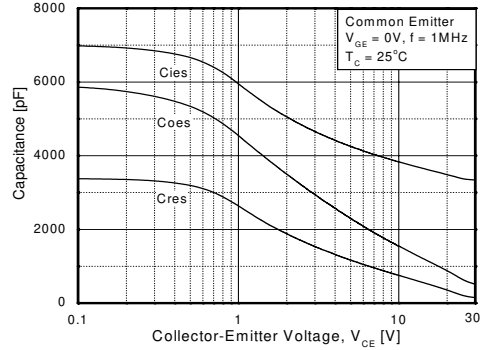

Figure 9. Gate Charge Characteristics

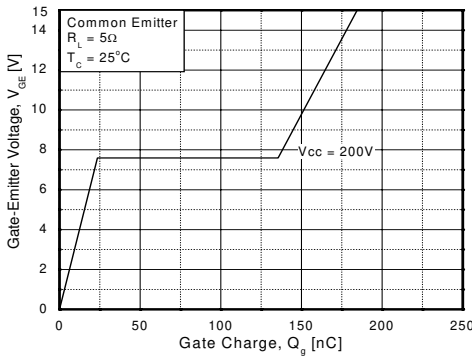

Figure 10. SOA Characteristics

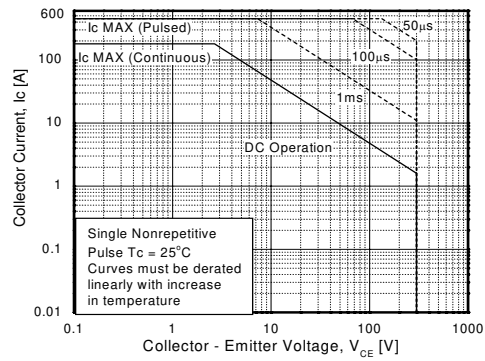

Figure 11. Turn-On Characteristics vs. Gate Resistance

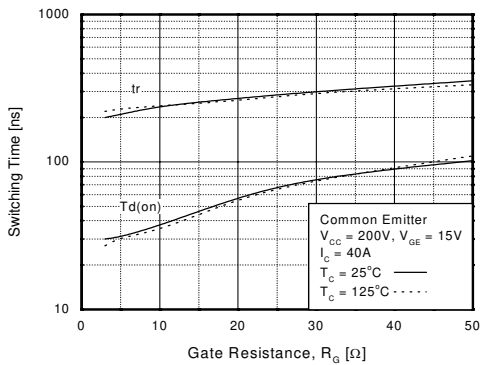
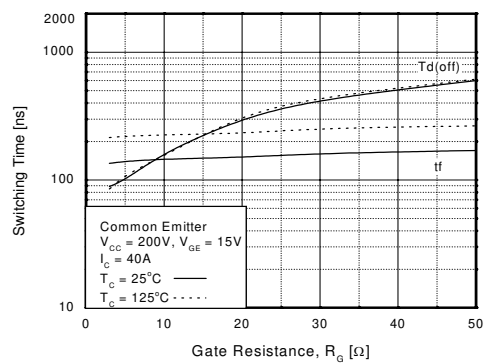

Figure 12. Turn Off Characteristics vs. Gate Resistance



Typical Performance Characteristics (Continued)

Figure 13. Turn-On Characteristics vs. Collector Current

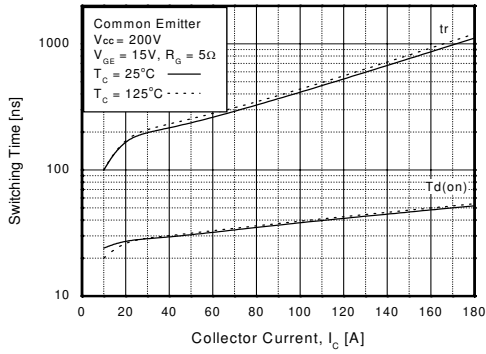

Figure 14. Turn-Off Characteristics vs. Collector Current

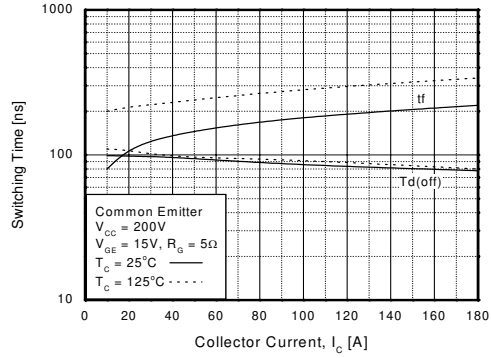

Figure 15. Switching Loss vs Gate Resistance

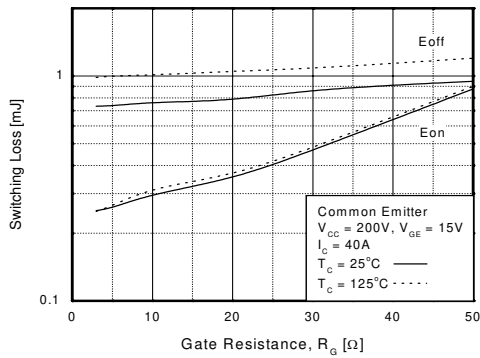

Figure 16. Switching Loss vs Collector Current

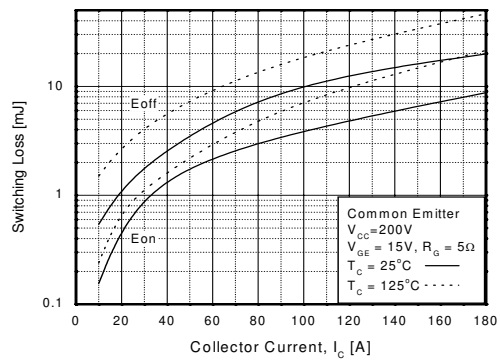
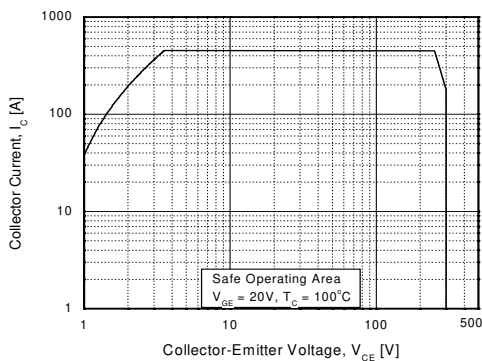

Figure 17. Turn Off SOA Characteristics



Typical Performance Characteristics (Continued)

Figure 18. Transient Thermal Impedance of IGBT

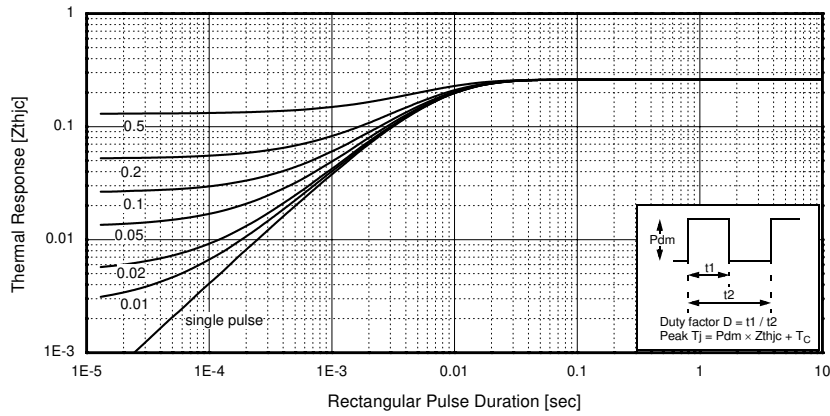

Figure 19. Forward Characteristics

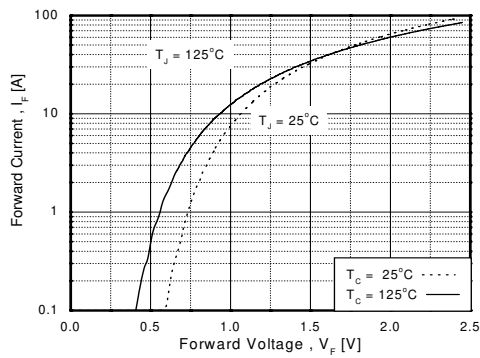

Figure 20. Typical Reverse Recovery Current

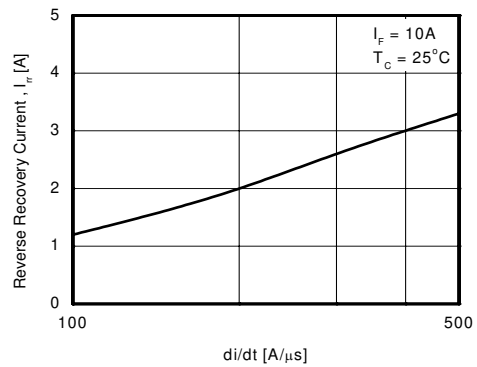
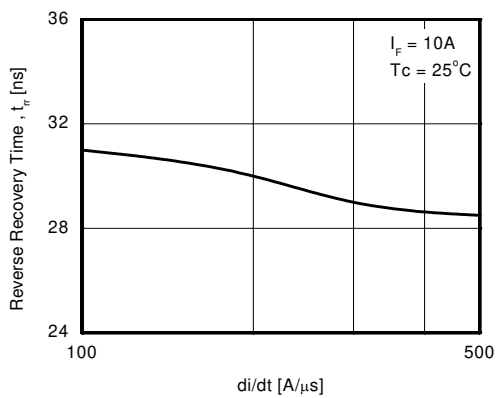
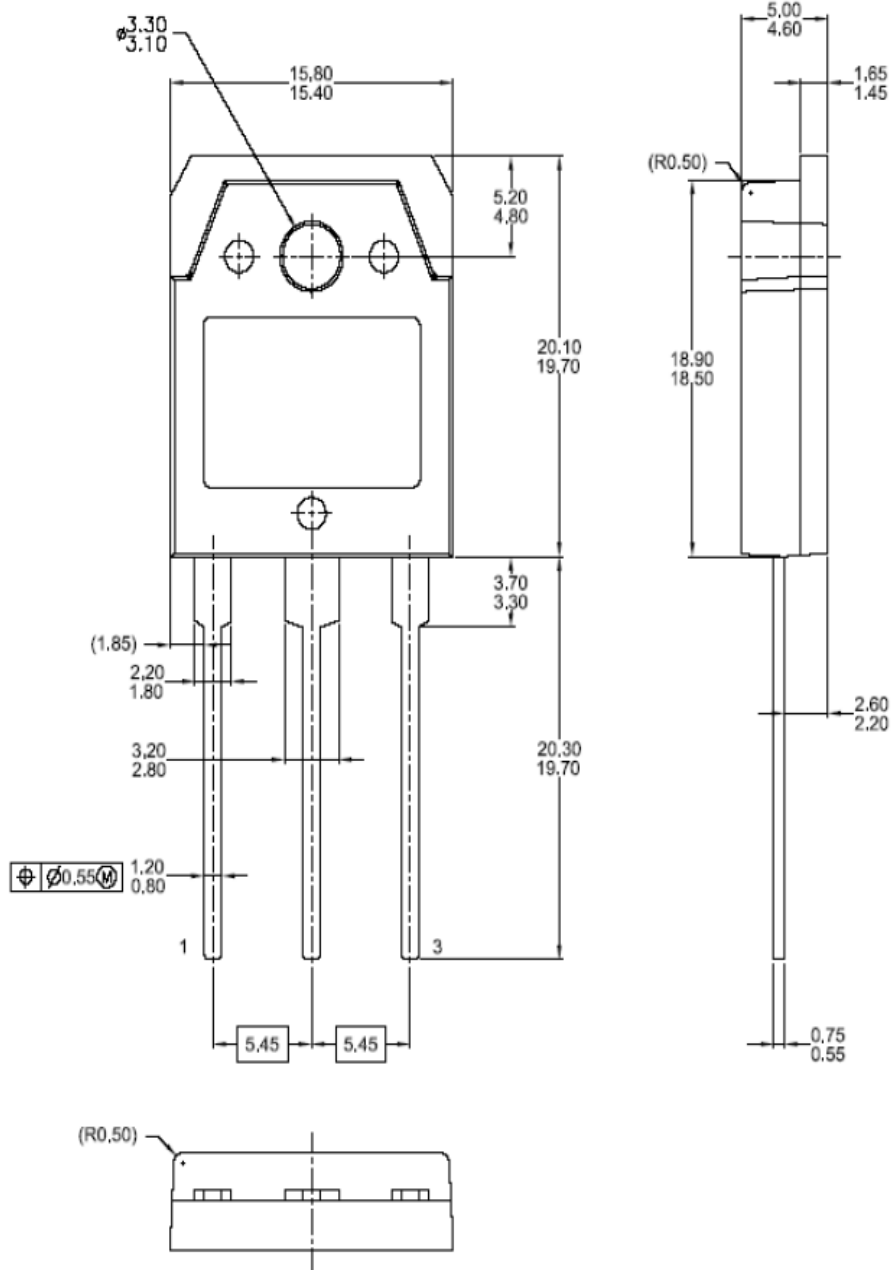

Figure 21. Typical Reverse Recovery Time



Mechanical Dimensions

TO-3PN



Dimensions in Millimeters

TRADEMARKS

The following are registered and unregistered trademarks Fairchild Semiconductor owns or is authorized to use and is not intended to be an exhaustive list of all such trademarks.

ACE _x ™	FAST®	ISOPLANAR™	PowerEdge™	SuperFET™
ActiveArray™	FAST _r ™	LittleFET™	PowerSaver™	SuperSOT™-3
Bottomless™	FPS™	MICROCOUPLER™	PowerTrench®	SuperSOT™-6
Build it Now™	FRFET™	MicroFET™	QFET®	SuperSOT™-8
CoolFET™	GlobalOptoisolator™	MicroPak™	QS™	SyncFET™
CROSSVOLT™	GTO™	MICROWIRE™	QT Optoelectronics™	TCM™
DOME™	HiSeC™	MSX™	Quiet Series™	TinyLogic®
EcoSPARK™	I ² C™	MSXPro™	RapidConfigure™	TINYOPTO™
E ² CMOS™	i-Lo™	OCX™	RapidConnect™	TruTranslation™
EnSigna™	ImpliedDisconnect™	OCXPro™	μSerDes™	UHC™
FACT™	IntelliMAX™	OPTOLOGIC®	ScalarPump™	UniFET™
FACT Quiet Series™		OPTOPLANAR™	SILENT SWITCHER®	UltraFET®
Across the board. Around the world.™		PACMAN™	SMART START™	VCX™
The Power Franchise®		POP™	SPM™	Wire™
Programmable Active Droop™		Power247™	Stealth™	

DISCLAIMER

FAIRCHILD SEMICONDUCTOR RESERVES THE RIGHT TO MAKE CHANGES WITHOUT FURTHER NOTICE TO ANY PRODUCTS HEREIN TO IMPROVE RELIABILITY, FUNCTION OR DESIGN. FAIRCHILD DOES NOT ASSUME ANY LIABILITY ARISING OUT OF THE APPLICATION OR USE OF ANY PRODUCT OR CIRCUIT DESCRIBED HEREIN; NEITHER DOES IT CONVEY ANY LICENSE UNDER ITS PATENT RIGHTS, NOR THE RIGHTS OF OTHERS. THESE SPECIFICATIONS DO NOT EXPAND THE TERMS OF FAIRCHILD'S WORLDWIDE TERMS AND CONDITIONS, SPECIFICALLY THE WARRANTY THEREIN, WHICH COVERS THESE PRODUCTS.

LIFE SUPPORT POLICY

FAIRCHILD'S PRODUCTS ARE NOT AUTHORIZED FOR USE AS CRITICAL COMPONENTS IN LIFE SUPPORT DEVICES OR SYSTEMS WITHOUT THE EXPRESS WRITTEN APPROVAL OF FAIRCHILD SEMICONDUCTOR CORPORATION.

As used herein:

1. Life support devices or systems are devices or systems which, (a) are intended for surgical implant into the body, or (b) support or sustain life, or (c) whose failure to perform when properly used in accordance with instructions for use provided in the labeling, can be reasonably expected to result in significant injury to the user.
2. A critical component is any component of a life support device or system whose failure to perform can be reasonably expected to cause the failure of the life support device or system, or to affect its safety or effectiveness.

PRODUCT STATUS DEFINITIONS

Definition of Terms

Datasheet Identification	Product Status	Definition
Advance Information	Formative or In Design	This datasheet contains the design specifications for product development. Specifications may change in any manner without notice.
Preliminary	First Production	This datasheet contains preliminary data, and supplementary data will be published at a later date. Fairchild Semiconductor reserves the right to make changes at any time without notice in order to improve design.
No Identification Needed	Full Production	This datasheet contains final specifications. Fairchild Semiconductor reserves the right to make changes at any time without notice in order to improve design.
Obsolete	Not In Production	This datasheet contains specifications on a product that has been discontinued by Fairchild semiconductor. The datasheet is printed for reference information only.

Rev. 119