

# VPL16-600

### Electrical Specifications (@25C)

1. Maximum Power: 10.0VA
2. Input Voltage – **Series:** 230VAC @ 50/60Hz, **Parallel:** 115VAC@ 50/60Hz
3. Output Voltage – **Series:** 16.0V CT@ 0.630A, **Parallel:** 8.0V @ 1.260A
4. Voltage Regulation: 20% TYP @ full load to no load
5. Hipot: 3500VAC between primary to secondary and windings to core.

### Construction:

Dual winding construction with an insulated shroud, both made of a high temperature material that exceeds UL flammability requirements. Shrouds are provided over the connections of the leads to the windings on both primary and secondary coils. Devices are designed with a minimum of 6mm creepage distance between the primary and secondary and are manufactured with a Class B (130°C) insulation system.

### Agency Files:

UL File: E65390, UL 5085-1 and 3 (formerly UL1585), Class 2/3  
 cUL: File E65390, For Canadian Use (CSA 22.2, No.66.1-06 and No.66.3-06)  
 TUV: File R72182067, EN 61558-1:2005+A1, EN61558-2-6:2009. Double Insulated. Non-inherently Short-Circuit-Proof.



Dimensions: Units: In inches

A	B	C	D	E	F
1.750	2.812	1.750	2.375	8.00	0.187

Weight: 0.7 lbs.

### Connections<sup>3</sup>:

**Input:** Series – BLK to BLU, Jumper WHT to BRN  
 Parallel – BLK to BLU, Jumper BLK to BRN and WHT to BLU

**Output:** Series – RED to GRY, Jumper YEL to VIO  
 Parallel – RED to GRY, Jumper RED to VIO and YEL to GRY

**RoHS Compliance:** As of manufacturing date February 2016, all standard products meet the requirements of 2015/863/EU, known as the RoHS 3 initiative.

\* Upon printing, this document is considered "uncontrolled". Please contact Triad Magnetics' website for the most current version.

<sup>1</sup> Inherently limited. No fusing required. Class 2 not wet, Class 3 wet.

<sup>2</sup> Inherently limited. No fusing required. Class 2.

<sup>3</sup> Primary and secondary windings are designed to be connected in series or parallel. Windings are not intended to be used independently.

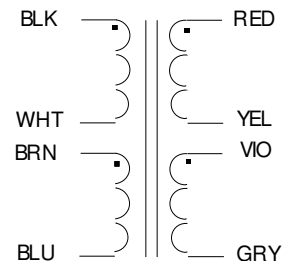
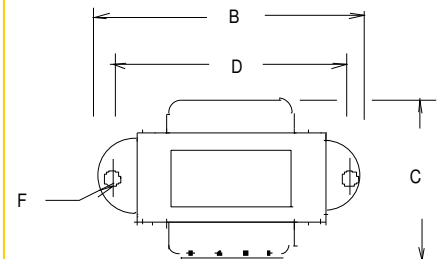
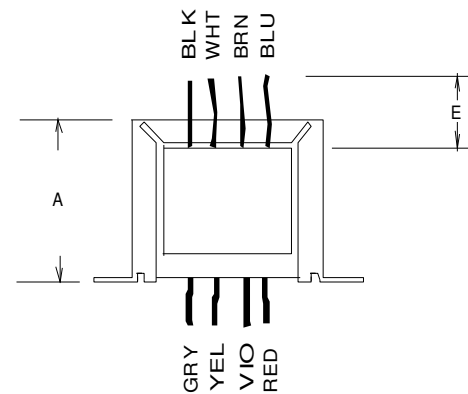
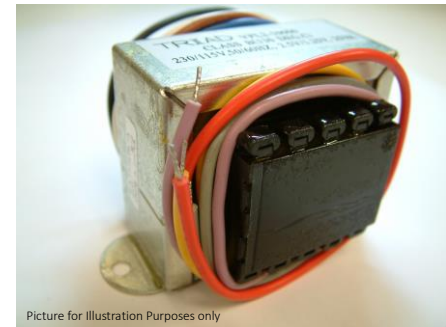

### SCHEMATIC