

*Phase leg
Intelligent Power Module*

$V_{CES} = 600V$
 $I_C = 400A @ T_c = 80^\circ C$

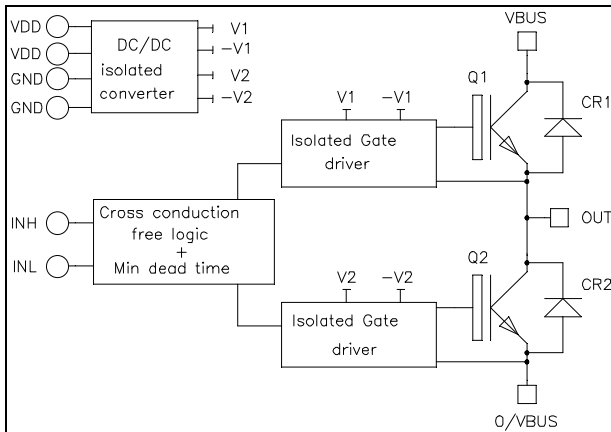

Application

- Motor control
- Uninterruptible Power Supplies
- Switched Mode Power Supplies
- Amplifier

Features

- **Non Punch Through (NPT) FAST IGBT**
 - Low voltage drop
 - Low tail current
 - Soft recovery parallel diodes
 - Low diode VF
 - Low leakage current
 - RBSOA & SCSOA rated
- **Integrated Fail Safe IGBT Protection (Driver)**
 - Top Bottom input signals Interlock
 - Isolated DC/DC Converter

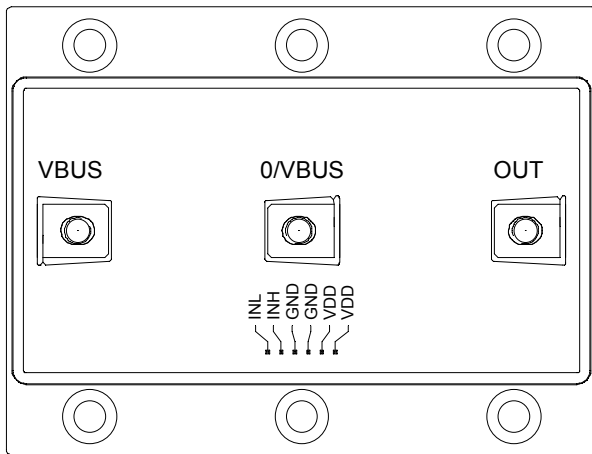

- Low stray inductance
- M5 power connectors
- High level of integration

Benefits

- Outstanding performance at high frequency operation
- Stable temperature behavior
- Very rugged
- Direct mounting to heatsink (isolated package)
- Low junction to case thermal resistance
- Very high noise immunity (common mode rejection > 25kV/μs)
- Galvanic Isolation: 3750V for the optocoupler
2500V for the transformer
- 5V logic level with Schmitt-trigger Input
- Single V_{DD}=5V supply required
- Secondary auxiliary power supplies internally generated (15V, -6V)
- Optocoupler qualified to AEC-Q100 test guidelines
- RoHS compliant

CAUTION: These Devices are sensitive to Electrostatic Discharge. Proper Handling Procedures Should Be Followed. See application note APT0502 on www.microsemi.com

All ratings @ $T_j = 25^\circ\text{C}$ unless otherwise specified

1. Inverter Power Module

Absolute maximum ratings

Symbol	Parameter	Max ratings	Unit
V_{CES}	Collector - Emitter Breakdown Voltage	600	V
I_C	Continuous Collector Current	$T_C = 25^\circ\text{C}$	600
		$T_C = 80^\circ\text{C}$	400
I_{CM}	Pulsed Collector Current	$T_C = 25^\circ\text{C}$	800
P_D	Maximum Power Dissipation	$T_C = 25^\circ\text{C}$	1250
RBSOA	Reverse Bias Safe Operating Area	$T_j = 150^\circ\text{C}$	800A@550V

Electrical Characteristics

Symbol	Characteristic	Test Conditions	Min	Typ	Max	Unit
I_{CES}	Zero Gate Voltage Collector Current	$V_{GE} = 0\text{V}$ $V_{CE} = 600\text{V}$	$T_j = 25^\circ\text{C}$		0.3	mA
			$T_j = 150^\circ\text{C}$		1	
$V_{CE(sat)}$	Collector Emitter Saturation Voltage	$V_{DD} = V_{IN} = 5\text{V}$ $I_C = 400\text{A}$	$T_j = 25^\circ\text{C}$	1.5	1.9	V
			$T_j = 150^\circ\text{C}$	1.7		

Dynamic Characteristics

Symbol	Characteristic	Test Conditions	Min	Typ	Max	Unit
C_{ies}	Input Capacitance	$V_{GE} = 0\text{V}$ $V_{CE} = 25\text{V}$ $f = 1\text{MHz}$		24		nF
C_{oes}	Output Capacitance			1.6		
C_{res}	Reverse Transfer Capacitance			0.8		
T_r	Rise Time	Inductive Switching (25°C) $V_{DD} = V_{IN} = 5\text{V}$ $V_{Bus} = 300\text{V}; I_C = 400\text{A}$		45		ns
T_f	Fall Time			55		
T_r	Rise Time	Inductive Switching (125°C) $V_{DD} = V_{IN} = 5\text{V}$ $V_{Bus} = 300\text{V}$ $I_C = 400\text{A}$		25		ns
T_f	Fall Time			70		
E_{on}	Turn-on Switching Energy	$V_{DD} = V_{IN} = 5\text{V}; V_{Bus} = 360\text{V}$ $t_p \leq 6\mu\text{s}; T_j = 150^\circ\text{C}$		3.5		mJ
E_{off}	Turn-off Switching Energy			14		
I_{sc}	Short Circuit data			2000		A
R_{thJC}	Junction to Case thermal resistance				0.12	$^\circ\text{C}/\text{W}$

Reverse diode ratings and characteristics

Symbol	Characteristic	Test Conditions		Min	Typ	Max	Unit
V _{RRM}	Maximum Peak Repetitive Reverse Voltage			600			V
I _{RM}	Maximum Reverse Leakage Current	V _R =600V	T _j = 25°C			350	μA
			T _j = 150°C			500	
I _F	DC Forward Current		T _c = 80°C		400		A
V _F	Diode Forward Voltage	I _F = 400A	T _j = 25°C		1.6	2	V
			T _j = 150°C		1.5		
t _{rr}	Reverse Recovery Time	I _F = 400A V _R = 300V di/dt = 4800A/μs	T _j = 25°C		125		ns
			T _j = 150°C		220		
Q _{rr}	Reverse Recovery Charge	I _F = 400A V _R = 300V di/dt = 4800A/μs	T _j = 25°C		19		μC
			T _j = 150°C		40		
E _{rr}	Reverse Recovery Energy	I _F = 400A V _R = 300V di/dt = 4800A/μs	T _j = 25°C		4.4		mJ
			T _j = 150°C		9.6		
R _{thJC}	Junction to Case thermal resistance					0.20	°C/W

2. Driver
Absolute maximum ratings

Symbol	Parameter	Max ratings	Unit
V _{DD}	Supply Voltage	5.5	V
V _{INi}	Input signal voltage i=L, H	5.5	
I _{VDDmax}	Maximum Supply current	V _{INi} = 0V, i = L & H	0.35
		V _{DD} = 5V, V _{INH} = V _{INL} ; F _{out} = 45kHz	2
f _{max}	Maximum Switching Frequency	45	kHz

Driver Electrical Characteristics

Symbol	Characteristic	Test Conditions	Min	Typ	Max	Unit
V _{DD}	Operating Supply Voltage		4.5	5	5.5	V
V _{INi(max)}	Maximum Input Voltage	i = L, H	-0.5	5	5.5	V
V _{INi(th+)}	Positive Going Threshold Voltage			3.2		
V _{INi(th-)}	Negative Going Threshold Voltage			1		
R _{INi}	Input Resistance *			1		kΩ
T _{d(on)}	Turn On delay time	Driver + IGBT		1100 [Ⓞ]		ns
D _T	Built in dead time			600		
T _{d(off)}	Turn Off delay time	Driver + IGBT		750		ns
PWD	Pulse Width Distortion				300	
PDD	Propagation Delay Difference between any two driver	T _{d(on)} - T _{d(off)}	-350		350	ns
V _{ISOL}	Primary to Secondary Isolation		2500			V _{RMS}

* Low impedance guarantees good noise immunity.

Typical IGBT Performance Curve

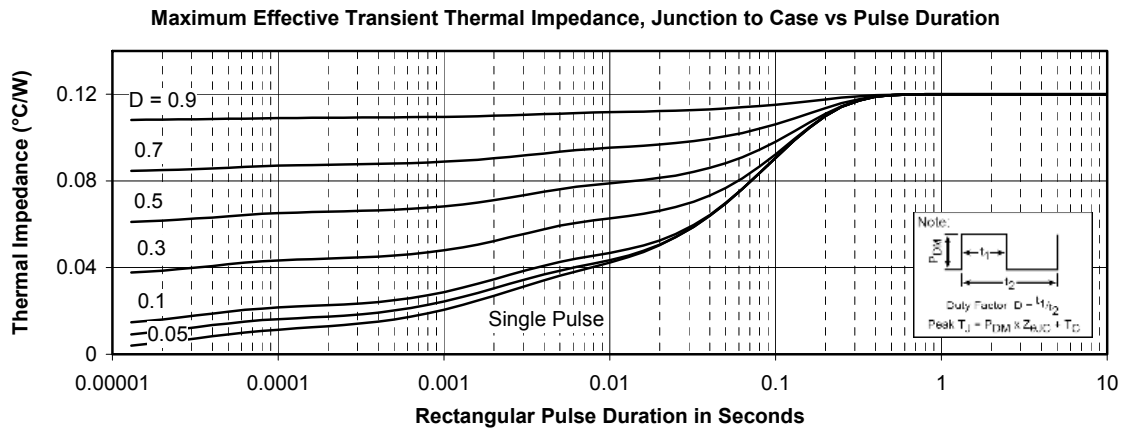
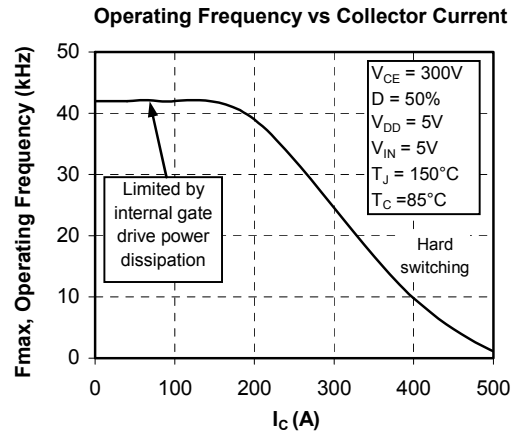
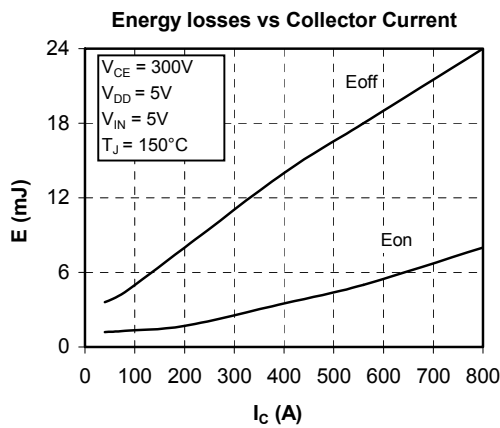
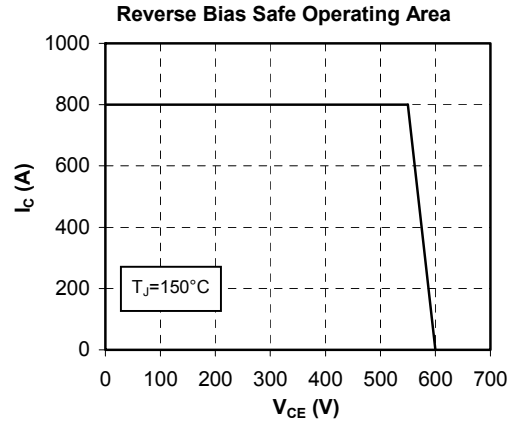
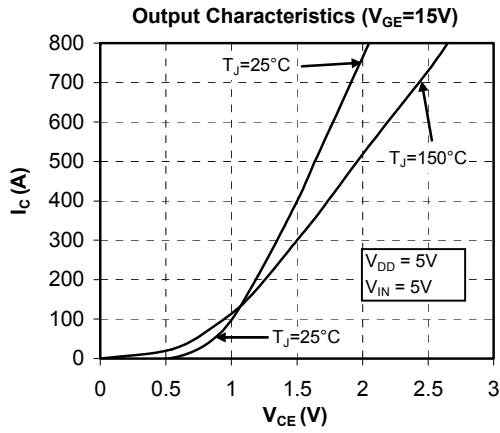

Typical diode Performance Curve

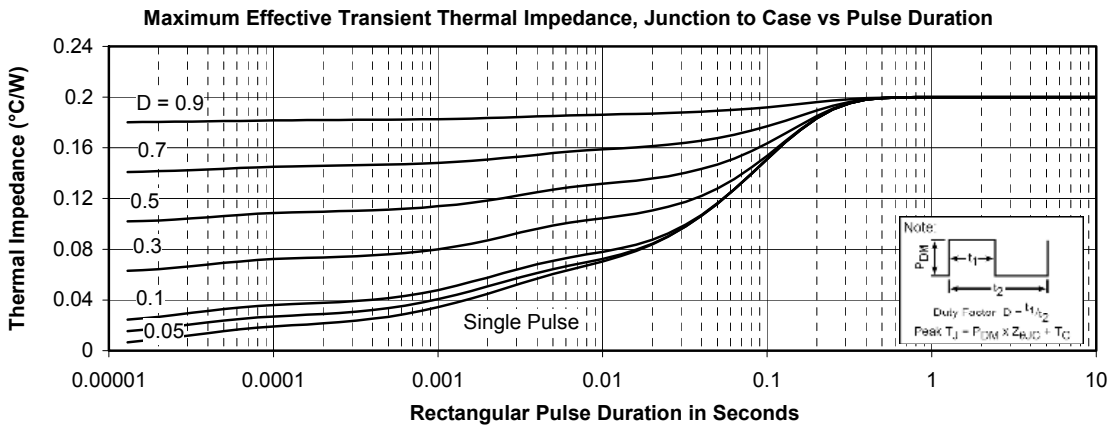
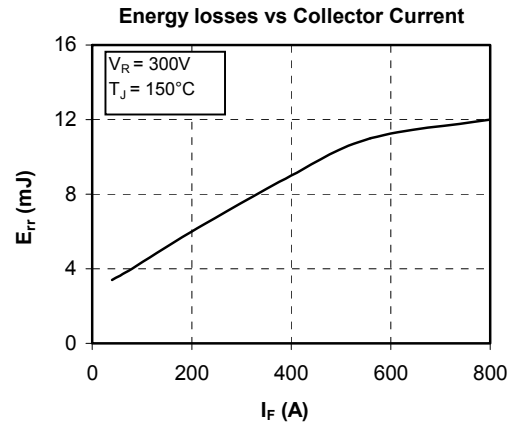
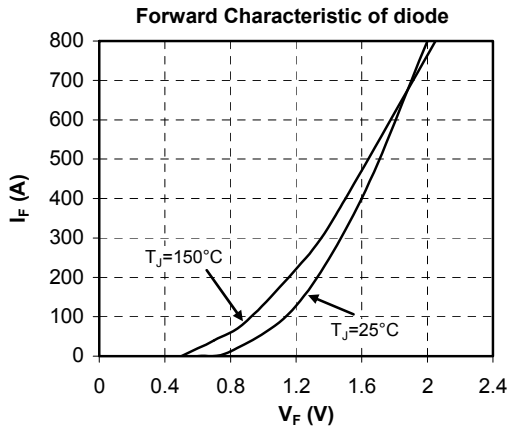

DISCLAIMER

The information contained in the document (unless it is publicly available on the Web without access restrictions) is PROPRIETARY AND CONFIDENTIAL information of Microsemi and cannot be copied, published, uploaded, posted, transmitted, distributed or disclosed or used without the express duly signed written consent of Microsemi. If the recipient of this document has entered into a disclosure agreement with Microsemi, then the terms of such Agreement will also apply. This document and the information contained herein may not be modified, by any person other than authorized personnel of Microsemi. No license under any patent, copyright, trade secret or other intellectual property right is granted to or conferred upon you by disclosure or delivery of the information, either expressly, by implication, inducement, estoppels or otherwise. Any license under such intellectual property rights must be approved by Microsemi in writing signed by an officer of Microsemi.

Microsemi reserves the right to change the configuration, functionality and performance of its products at anytime without any notice. This product has been subject to limited testing and should not be used in conjunction with life-support or other mission-critical equipment or applications. Microsemi assumes no liability whatsoever, and Microsemi disclaims any express or implied warranty, relating to sale and/or use of Microsemi products including liability or warranties relating to fitness for a particular purpose, merchantability, or infringement of any patent, copyright or other intellectual property right. Any performance specifications believed to be reliable but are not verified and customer or user must conduct and complete all performance and other testing of this product as well as any user or customers final application. User or customer shall not rely on any data and performance specifications or parameters provided by Microsemi. It is the customer's and user's responsibility to independently determine suitability of any Microsemi product and to test and verify the same. The information contained herein is provided "AS IS, WHERE IS" and with all faults, and the entire risk associated with such information is entirely with the User. Microsemi specifically disclaims any liability of any kind including for consequential, incidental and punitive damages as well as lost profit. The product is subject to other terms and conditions which can be located on the web at <http://www.microsemi.com/legal/tnc.asp>

Life Support Application

Seller's Products are not designed, intended, or authorized for use as components in systems intended for space, aviation, surgical implant into the body, in other applications intended to support or sustain life, or for any other application in which the failure of the Seller's Product could create a situation where personal injury, death or property damage or loss may occur (collectively "Life Support Applications").

Buyer agrees not to use Products in any Life Support Applications and to the extent it does it shall conduct extensive testing of the Product in such applications and further agrees to indemnify and hold Seller, and its officers, employees, subsidiaries, affiliates, agents, sales representatives and distributors harmless against all claims, costs, damages and expenses, and attorneys' fees and costs arising, directly or indirectly, out of any claims of personal injury, death, damage or otherwise associated with the use of the goods in Life Support Applications, even if such claim includes allegations that Seller was negligent regarding the design or manufacture of the goods.

Buyer must notify Seller in writing before using Seller's Products in Life Support Applications. Seller will study with Buyer alternative solutions to meet Buyer application specification based on Sellers sales conditions applicable for the new proposed specific part.