

Datasheet

Piezoelectric Proximity Mode Sensors with Push Button Programming of Sensing Window Limits – Bipolar Discrete Outputs

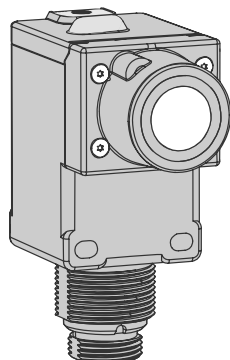

- Ultrasonic proximity detection from 250 mm to 3.0 m (9.8 in to 118 in)
- Push-button TEACH-mode programming of sensing window limits
- Digital filtering for exceptional immunity to electrical and acoustic noise
- 12 DC to 24 V DC operation
- Bipolar outputs: one NPN and one PNP
- ON/OFF presence detection or HIGH/LOW level control are switch selectable
- Wide operating temperature range of $-25\text{ }^{\circ}\text{C}$ to $+70\text{ }^{\circ}\text{C}$ ($-13\text{ }^{\circ}\text{F}$ to $+158\text{ }^{\circ}\text{F}$); all models include temperature compensation
- Rugged design for use in demanding sensing environments; rated IP67, NEMA 6P
- Choose models with an integral unterminated 2 m (6.5 ft) or 9 m (30 ft) cable, or with a 7/8 in-16UNF or M12 quick-disconnect connector
- External enable/disable feature for remote gating control

Analog models are also available
Models with other ranges are also available



WARNING:

- **Do not use this device for personnel protection**
- Using this device for personnel protection could result in serious injury or death.
- This device does not include the self-checking redundant circuitry necessary to allow its use in personnel safety applications. A device failure or malfunction can cause either an energized (on) or de-energized (off) output condition.

Models

Models	Connection ¹	Output Type	Response Time
Q45UBB63BC	2 m (6.5 ft) unterminated cable	Bipolar NPN/PNP	Programmable for 40, 80, 320, or 1280 milliseconds
Q45UBB63BCQ	Integral 5-Pin 7/8 in-16UNF male quick-disconnect connector		
Q45UBB63BCQ6	Integral 5-pin M12 male quick-disconnect connector		

Temperature Compensation

All models listed above feature temperature compensation. An increase in air temperature shifts both sensing window limits closer to the sensor. Conversely, a decrease in air temperature shifts both limits further away from the sensor. The shift is approximately 3.5% of the limit distance for a 20 °C change in temperature.

Temperature compensated models maintain the position of both sensing window limits to within 1% of each limit distance over the 0 °C to +50 °C (+32 °F to +122 °F) range, and to within 2.5% over the full operating range of $-25\text{ }^{\circ}\text{C}$ to $+70\text{ }^{\circ}\text{C}$ ($-13\text{ }^{\circ}\text{F}$ to $+158\text{ }^{\circ}\text{F}$).

Overview

Near and Far Sensing Limit Settings. The Q45U features a single push button for programming the sensing window near and far limits.

Status Indicators. Status indicator LEDs are visible through the transparent, o-ring sealed polycarbonate top cover. Indicator function in the Run mode is as follows:

- The green LED is on when power is applied to the sensor and flashes to indicate an overloaded output.

¹ To order 9 m (30 ft) cable models, add the suffix "W/30" to the model number of any cabled sensor (for example, Q45UBB63BC W/30). Models with a quick-disconnect connector require an optional mating cable.



- The red LED flashes when an echo is received; the flash rate is proportional to echo strength.
- The amber LED is on when the outputs are conducting.

Figure 1. Q45U Long-Range Features

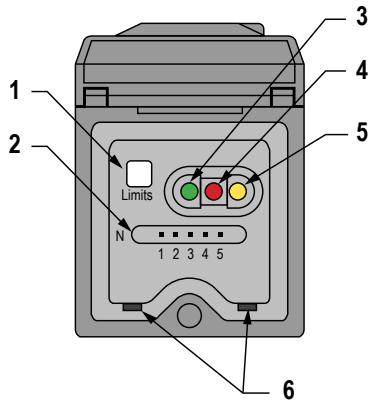

1. Button for programming the sensing window limits
2. 5-Segment target position indicator (N = Near)
3. Green power indicator
4. Red signal indicator
5. Amber output indicator
6. Slots for removing the inner cover

The 5-segment moving dot LED indicator displays the relative position of the target within the programmed sensing window. The #1 LED flashes when the target is closer than the near limit. The #5 LED flashes when the target is beyond the far limit.

Setting the DIP Switches

Output Response Settings.



Important: Disconnect the power before making any internal adjustments.

1. Insert a small flat-blade screwdriver into the slots.
2. Lift up and remove the black inner cover to expose the 4-position DIP switch.
3. Use the DIP switches to program the following functions:

Figure 2. Q45U Programming Switches

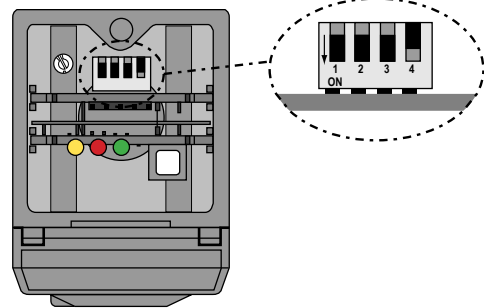

DIP Switches	Function															
1	ON/OFF Mode Output: On = normally closed (output energizes when target is absent) Off * = normally open (output energizes when target sensed)															
2	HIGH/LOW Mode On = Pump Out Off = Pump In															
3 and 4	<table border="1"> <thead> <tr> <th>Response (40 ms/cycle)</th> <th>Switch 3</th> <th>Switch 4</th> </tr> </thead> <tbody> <tr> <td>1 cycle</td> <td>OFF</td> <td>OFF</td> </tr> <tr> <td>2 cycles</td> <td>ON</td> <td>OFF</td> </tr> <tr> <td>8 cycles *</td> <td>OFF *</td> <td>ON *</td> </tr> <tr> <td>32 cycles</td> <td>ON</td> <td>ON</td> </tr> </tbody> </table>	Response (40 ms/cycle)	Switch 3	Switch 4	1 cycle	OFF	OFF	2 cycles	ON	OFF	8 cycles *	OFF *	ON *	32 cycles	ON	ON
Response (40 ms/cycle)	Switch 3	Switch 4														
1 cycle	OFF	OFF														
2 cycles	ON	OFF														
8 cycles *	OFF *	ON *														
32 cycles	ON	ON														

* Factory default setting.



Important: A response setting of 2 cycles, or higher, is recommended for optimum sonic and electrical noise immunity. Always use the slowest acceptable response speed for your application. Single cycle update is only recommended for short range (>1.0 m) applications looking for a stationary background target.

Figure 3. High/Low Control (DIP Switch 2 in ON)

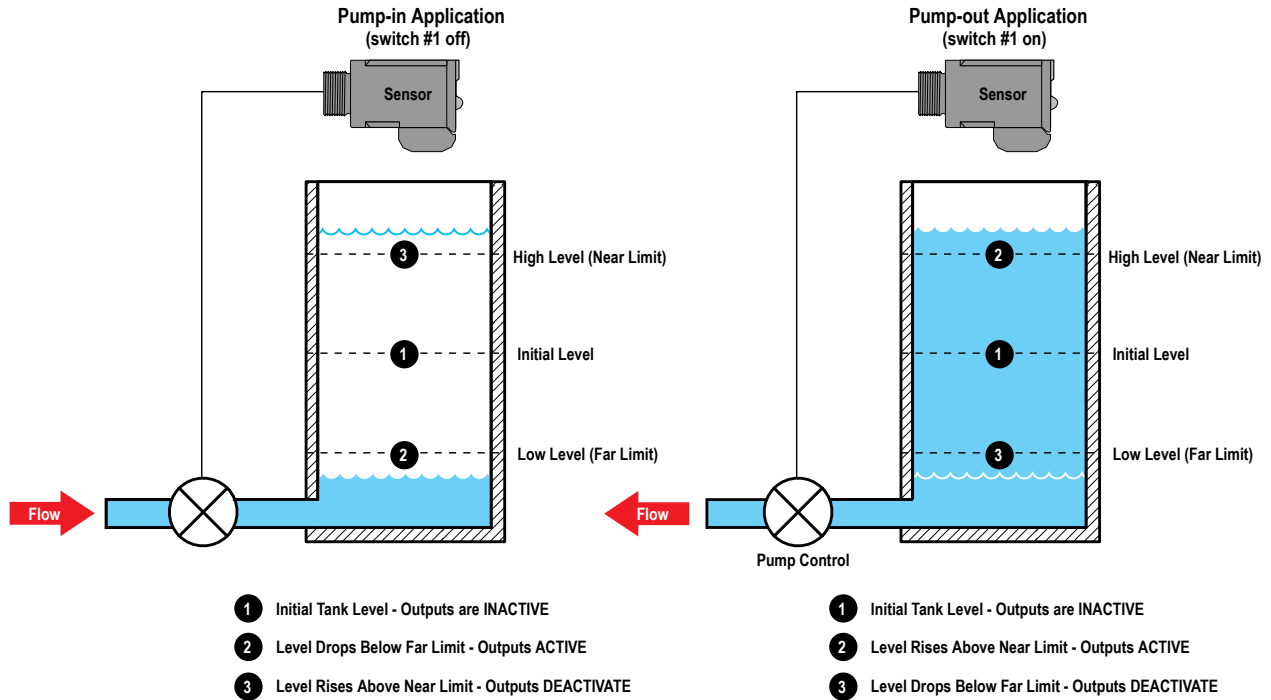

Note: If no echo is received by the sensor, the target is assumed to be beyond the far window limit.

The **HIGH/LOW** mode (DIP switch 2 is ON) provides the switching logic required for fill-level, web tensioning control, and similar applications. In the HIGH/LOW mode, the output energizes when the target reaches the first sensing window limit, and stays energized until the target moves to the second limit. The output then de-energizes at the second limit and does not re-energize until the target moves, again, to the first limit. This example shows how pumping action might be controlled, directly, by the sensor in a fill-level application.

Programming the Window Limit

Use the **Limits** button, located under the transparent top cover, to program the near and the far limits.

The near limit may be set as close as 250 mm (9.8 in) and the far limit may be set as far as 3.0 m (118 in) from the transducer face. The minimum window width is 25 mm (1.0 in). When possible, use the actual target to be sensed when setting the window limits. Programming the window limit begins with the sensor in Run mode.

1. Push and hold the **Limits** button until the green LED turns off (approximately 2 seconds).

Green LED	Amber LED	Red LED
Off	On to indicate the sensor is ready to program the first limit	Flashes to indicate the strength of the echo; Off if no target is present

2. Set the first limit (near or far) by placing the target at the first limit and pressing the **Limits** button for less than 2 seconds.

Green LED	Amber LED	Red LED
Off	Flashes at 2 Hz to indicate the sensor is ready to program the second limit	On for a moment, then resumes flashing to indicate the strength of the echo

3. Set the second limit (far or near) by placing the target at the second limit and pressing the **Limits** button for less than 2 seconds.

Green LED	Amber LED	Red LED
Off, then turns on when the sensor returns to Run mode	On for a moment, then is either on or off to indicate the output state when the sensor returns to Run mode	On for a moment, then resumes flashing to indicate the strength of the echo when the sensor returns to Run mode

Notes regarding window limit programming:

1. Either the near or far limit may be programmed first.
2. There is a 2-minute timeout for programming of the first limit. The sensor returns to Run mode with the previously programmed limits. There is no timeout between the programming of the first and second limit.

3. Cancel the programming sequence at any time by pressing and holding the **Limits** button for ≥ 2 seconds. The sensor returns to Run mode with the previously programmed limits.
4. During limit programming, the 5-segment moving dot indicator displays the relative target position between 0 m and 4.0 m (0 ft and 13.1 ft). The maximum recommended far limit position is 3.0 m (9.84 ft).
5. If the target is positioned between 3.0 and 4.0 m (9.84 ft to 13.1 ft), the 5th segment of the moving dot indicator flashes to indicate that a valid echo is received, but the target is beyond the recommended 3.0 m (9.84 ft) maximum far limit.
6. If a limit is rejected during either programming step, the sensor reverts to the first limit programming step. This is indicated by the green LED (OFF), red LED (flashing to indicate signal strength), and the amber LED (ON).
7. If both limits are accepted, the sensor returns to Run mode, which is indicated by the green LED (ON).
8. If the target is held at the same position for programming of both limits, the sensor establishes a 50 mm wide sensing window, centered on the target position.

Wiring Diagrams

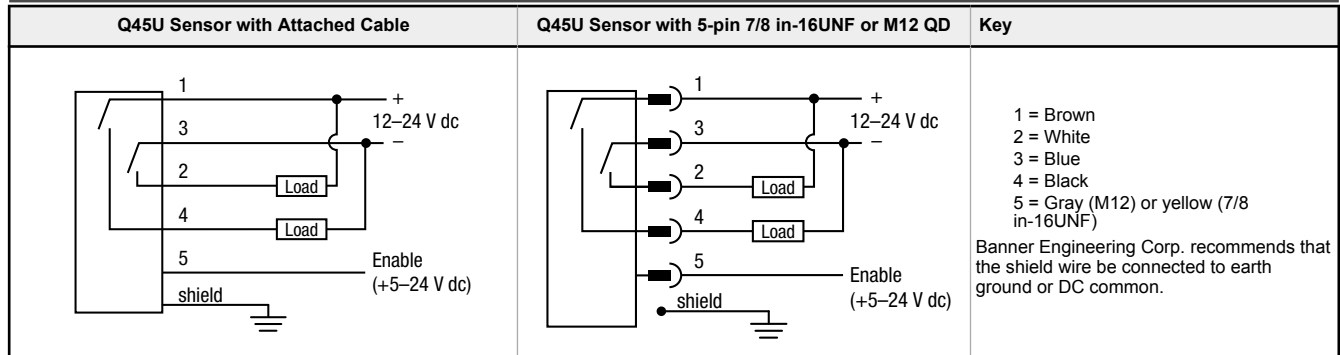

Specifications

Supply Voltage and Current

12 DC to 24 V DC (10% maximum ripple) at 100 mA, exclusive of load

Proximity Mode Range

Near limit: 250 mm (9.8 in) minimum
 Far limit: 3.0 m (118 in)

Note: The far limit may be extended as far as 3.9 m (12.79 ft) for good acoustical targets (hard surfaces with an area $> 100 \text{ cm}^2$)

Supply Protection Circuitry

Protected against reverse polarity and transient voltages

Output Configuration

Bipolar: one current PNP and one current NPN open-collector transistor
 Use the 4-position DIP switch to select the following:

- Switch 1: Output normally open/normally closed (pump in/pump out)
- Switch 2: High/Low level control mode or on/off presence sensing mode
- Switch 3 & 4: Response speed selection (digital filter)

Output Rating

150 mA maximum (each)
 Off-state leakage current: < 25 microamp at 24 V DC
 On-state saturation voltage: $< 1.5 \text{ V}$ at 10 mA; $< 2.0 \text{ V}$ at 150 mA

Output Protection Circuitry

Protected against false pulse on power-up and continuous overload or short-circuit of outputs

Hysteresis

ON/OFF mode: 10 mm
 HIGH/LOW mode: 0 mm

Certifications



Banner Engineering
 Europe Park Lane,
 Culliganlaan 2F bus 3,
 1831 Diegem,
 BELGIUM



Turck Banner LTD
 Blenheim House,
 Blenheim Court,
 Wickford, Essex SS11
 8YT, Great Britain

Performance Specifications

Repeatability: $\pm 0.1\%$ of measured distance ($\pm 0.50 \text{ mm min}$)
 Minimum Window Width: 25 mm (1.0 in)
 Hysteresis: 10 mm (0.4 in)

Indicators

Three status LEDs:

- Green ON = power to sensor is ON
- Green flashing = output is overloaded
- Amber ON = outputs are conducting (in Run mode); or programming status (in Setup mode)
- Red flashing = indicates relative strength of received echo

5-segment moving dot LED indicates the position of the target within the sensing window

Construction

Molded PBT thermoplastic polyester housing, o-ring sealed transparent acrylic top cover, and stainless steel hardware.
 Q45U sensors are designed to withstand 1200 psi washdown.
 The base of cabled models has a 1/2"-14 NPS internal conduit thread

Connections

2 m (6.5 ft) or 9 m (30 ft) attached cable, integral 5-pin 7/8 in-16UNF male quick-disconnect connector, or integral 5-pin M12 male quick-disconnect connector

Environmental Rating

Leakproof design is rated IP67; NEMA 6P

Operating Conditions

Temperature: $-25 \text{ }^\circ\text{C}$ to $+70 \text{ }^\circ\text{C}$ ($-13 \text{ }^\circ\text{F}$ to $+158 \text{ }^\circ\text{F}$)
 Maximum relative humidity: 100%

Vibration and Mechanical Shock

All models meet MIL-STD-202F, Method 201A (Vibration: 10 Hz to 60 Hz maximum, 0.06 inch (1.52 mm) double amplitude, 10G maximum acceleration) requirements. Also meets IEC 60947-5-2 (Shock: 30G 11 ms duration, half sine wave) requirements. Method 213B conditions H & I (Shock: 75G with unit operating; 100G for non-operation).

Application Notes

Minimum target size: 50 mm \times 50 mm aluminum plate at 3.0 m (118 in)
 Enable/Disable: Connect the yellow wire to +5 to 24 V DC to enable the sensor and 0 to +2 V DC to disable the sensor. When the sensor is disabled, the last output state is held until the sensor is re-enabled. Hold the wire to the appropriate voltage for at least 40 ms to enable or disable the sensor.

Performance Curves

Effective Beam with 100 × 100 mm Plate Target (Typical)

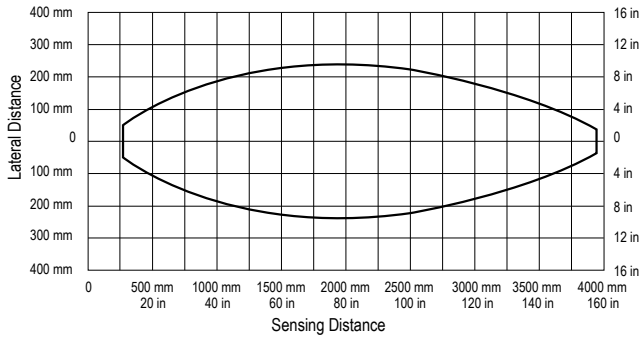

Effective Beam with 2.5 cm Rod Target (Typical)

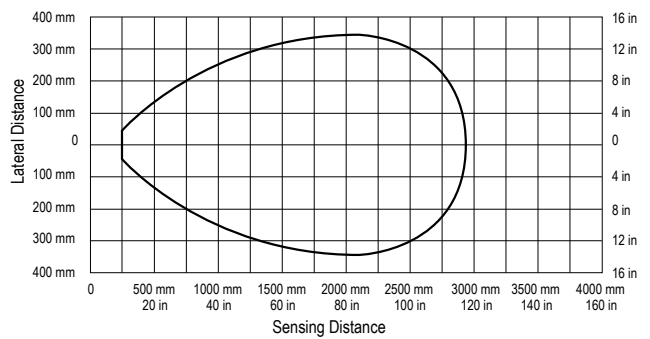

Dimensions

Cabled Models

5-pin 7/8 in-16UNF QD Models

5-pin M12 QD Models

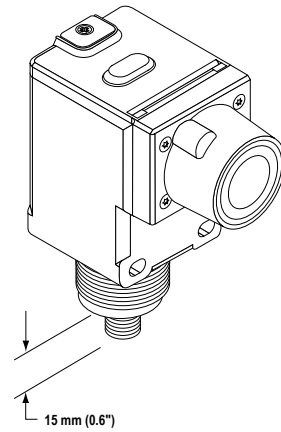
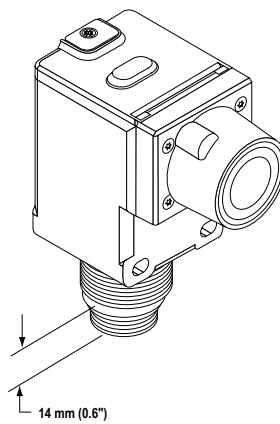
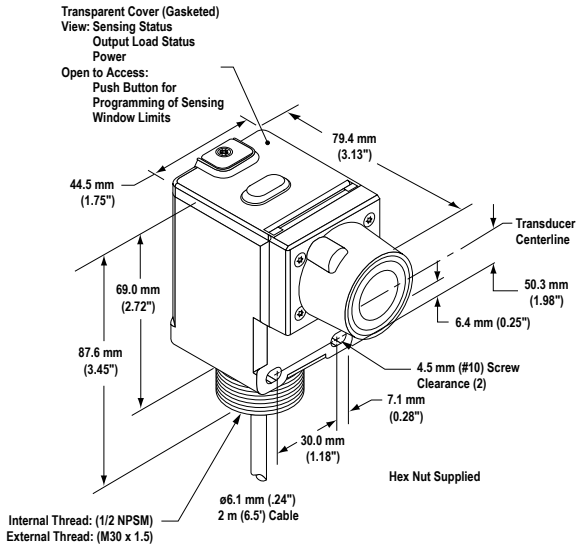

Accessories

Cordsets

5-Pin 7/8-in Cordsets with Shield—Single Ended				
Model	Length	Style	Dimensions	Pinout (Female)
MBCC2-506	2 m (6.56 ft)	Straight		<p>1 = Brown 2 = White 3 = Blue 4 = Black 5 = Yellow</p>
MBCC2-512	4 m (13.1 ft)			
MBCC2-530	9 m (29.5 ft)			

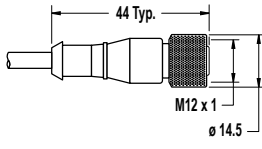
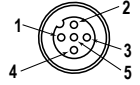
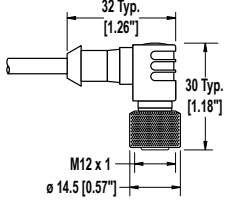
5-Pin Threaded M12 Cordsets with Shield—Single Ended				
Model	Length	Style	Dimensions	Pinout (Female)
MQDEC2-506	2 m (6.56 ft)	Straight		
MQDEC2-515	5 m (16.4 ft)			
MQDEC2-530	9 m (29.5 ft)			
MQDEC2-550	15 m (49.2 ft)			
MQDEC2-575	23 m (75.44 ft)			
MQDEC2-5100	30.5 m (100 ft)			
MQDEC2-506RA	2 m (6.56 ft)	Right-Angle		1 = Brown 2 = White 3 = Blue 4 = Black 5 = Gray
MQDEC2-515RA	5 m (16.4 ft)			
MQDEC2-530RA	9 m (29.5 ft)			
MQDEC2-550RA	15 m (49.2 ft)			
MQDEC2-575RA	23 m (75.44 ft)			
MQDEC2-5100RA	31 m (101.68 ft)			

Brackets

SMB30S

- Swivel bracket with 30 mm mounting hole for sensor
- Adjustable captive swivel ball
- Black reinforced thermoplastic polyester
- Stainless steel mounting and swivel locking hardware included

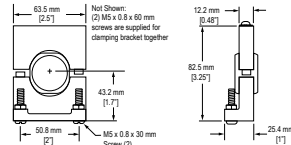

SMB30C

- 30 mm split clamp, black PBT bracket
- Stainless steel mounting hardware included
- Mounting hole for 30 mm sensor

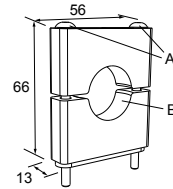

Hole center spacing: A=ø 45
Hole size: B=ø 27.2

SMB30MM

- 12-ga. stainless steel bracket with curved mounting slots for versatile orientation
- Clearance for M6 (¼ in) hardware
- Mounting hole for 30 mm sensor

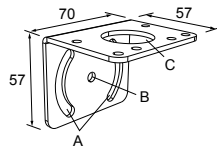

Hole center spacing: A = 51, A to B = 25.4
Hole size: A = 42.6 x 7, B = ø 6.4, C = ø 30.1

Banner Engineering Corp. Limited Warranty

Banner Engineering Corp. warrants its products to be free from defects in material and workmanship for one year following the date of shipment. Banner Engineering Corp. will repair or replace, free of charge, any product of its manufacture which, at the time it is returned to the factory, is found to have been defective during the warranty period. This warranty does not cover damage or liability for misuse, abuse, or the improper application or installation of the Banner product.

THIS LIMITED WARRANTY IS EXCLUSIVE AND IN LIEU OF ALL OTHER WARRANTIES OR IMPLIED (INCLUDING, WITHOUT LIMITATION, ANY WARRANTY OF MERCHANTABILITY OR FITNESS FOR A PARTICULAR PURPOSE), AND WHETHER ARISING UNDER COURSE OF PERFORMANCE, COURSE OF DEALING OR TRADE USAGE.

This Warranty is exclusive and limited to repair or, at the discretion of Banner Engineering Corp., replacement. **IN NO EVENT SHALL BANNER ENGINEERING CORP. BE LIABLE TO BUYER OR ANY OTHER PERSON OR ENTITY FOR ANY EXTRA COSTS, EXPENSES, LOSSES, LOSS OF PROFITS, OR ANY INCIDENTAL, CONSEQUENTIAL OR SPECIAL DAMAGES RESULTING FROM ANY PRODUCT DEFECT OR FROM THE USE OR INABILITY TO USE THE PRODUCT, WHETHER ARISING IN CONTRACT OR WARRANTY, STATUTE, TORT, STRICT LIABILITY, NEGLIGENCE, OR OTHERWISE.**

Banner Engineering Corp. reserves the right to change, modify or improve the design of the product without assuming any obligations or liabilities relating to any product previously manufactured by Banner Engineering Corp. Any misuse, abuse, or improper application or installation of this product or use of the product for personal protection applications when the product is identified as not intended for such purposes will void the product warranty. Any modifications to this product without prior express approval by Banner Engineering Corp will void the product warranties. All specifications published in this document are subject to change; Banner reserves the right to modify product specifications or update documentation at any time. Specifications and product information in English supersede that which is provided in any other language. For the most recent version of any documentation, refer to: www.bannerengineering.com.

For patent information, see www.bannerengineering.com/patents.