

200 mA output current with thermal shutdown and output current limiter, 3.1 MHz, 36 V, BiCMOS dual operational amplifier

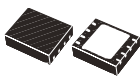

SO8 Exposed Pad

 DFN8 (3 x 3 mm)
Exposed Pad, Wettable Flank

Maturity status link

[TSB582](#)

Features

- Wide supply voltage: 4 V - 36 V
- High output current 200 mA
- Rail-to-rail output, low rail input
- Gain bandwidth product: 3.1 MHz
- High slew rate: 2 V/ μ s
- Internal thermal shutdown & output current limiter
- Enhanced RF noise immunity
- High tolerance to ESD: 4 kV HBM
- Extended temperature range: -40 °C to 125 °C
- Automotive grade
- Low noise 45 nV/ $\sqrt{\text{Hz}}$ @ 1 kHz
- I_{CC} (typ.) = 2.3 mA
- Unity gain stable
- Low offset 2.4 mV max. (25 °C) / 3 mV max. (full temperature range)
- Low input bias current
- Packages: SO8 & DFN8 exposed pad

Applications

- Servo driver
- Valve driver
- DC power supply, AC source
- Portable instrumentation
- Line drivers
- Motor control
- Angle resolver
- LED driver
- Industrial process control

Description

The **TSB582** is a unity gain stable, dual operational amplifier with high voltage and high current capability, featuring internal protections against overtemperature and current overload conditions. In addition, the **TSB582** has enhanced ESD and RF noise immunity.

It typically outputs up to 200 mA per channel to drive low resistance inductive loads such as angle resolvers, lineout cables and piezo actuators.

The two high current output amplifiers of the **TSB582** feature the advantage of driving loads directly in bridge tied mode or, connected in parallel, allow to double the output sink/source current. Additionally, the **TSB582** is available in the two space-saving packages, SO8 with exposed pad and DFN8 with wettable flanks and exposed pad. Where both of them are qualified for automotive applications over a temperature range of -40 °C to +125 °C.

1 Pin configuration

Figure 1. Pin connections for each package (top view)

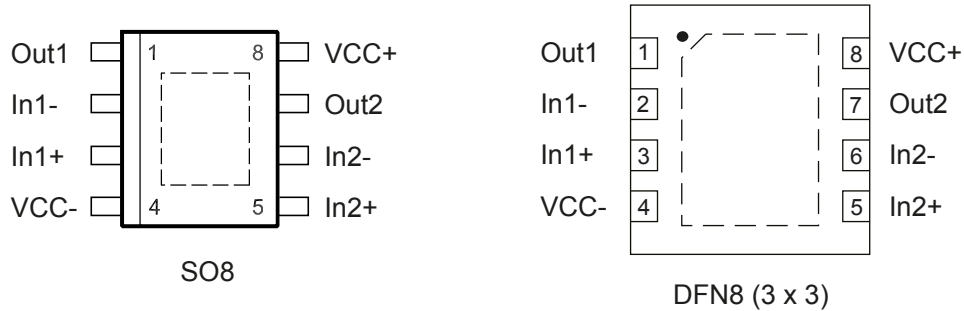

Table 1. Pin description (SO8/DFN8)

Pin n°	Pin name	Description
1	Out1	Output channel 1
2	In1-	Inverting input channel 1
3	In1+	Non-inverting input channel 1
4	VCC-	Negative supply voltage
5	In2+	Non-inverting input channel 2
6	In2-	Inverting input channel 2
7	Out2	Output channel 2
8	VCC+	Positive supply voltage
	ep	Exposed pad ⁽¹⁾

1. Exposed pad can be left floating or connected to VCC-.

2 Maximum ratings

Table 2. Absolute maximum ratings

Symbols	Parameters	Value	Unit
V_{CC}	Supply voltage ⁽¹⁾	42	V
V_{id}	Differential input voltage ⁽²⁾	± 42	
V_{in}	Input voltage ⁽³⁾	$V_{CC-} - 0.2\text{ V}$ to $V_{CC+} + 0.2\text{ V}$	
I_{in}	Input current ⁽⁴⁾	± 27	mA
V_O	Output voltage ⁽⁵⁾	$V_{CC-} - 0.5\text{ V}$ to $V_{CC+} + 0.5\text{ V}$	V
I_O	Output current	See Section 5.7 Safe operating area	
T_{stg}	Storage temperature	-65 to 150	°C
T_j	Maximum junction temperature	150	
R_{thJA}	Thermal resistance junction-to-ambient ⁽⁶⁾⁽⁷⁾		°C/W
	SO8 EP	45	
	DFN8 3x3 EP	40	
ESD	HBM ⁽⁸⁾	4	kV
	CDM ⁽⁹⁾	1.5	

- All voltage values, except the differential voltage, are with respect to the network ground terminal.
- Differential input voltage is the voltage difference between non-inverting input and inverting input. This voltage may be exceeded by using external resistors, see Section 5.2 ESD and input protection.
- Input voltage is the voltage allowed to apply to the input terminal independently from V_{CC} value.
- If the Input voltage exceeds the supply voltage or the differential input voltage V_{id} , the input current must be limited to 27 mA by using a series resistor on the inputs. See Section 5.2 ESD and input protection.
- Output voltage is the voltage allowed to apply independently from V_{CC} value.
- R_{th} are typical values for exposed pads soldered onto the circuit board. (JEDEC JESD51).
- Short-circuits can cause excessive heating and destructive dissipation.
- According to AECQ101-001.
- According to AECQ101-005.

2.1 Operating condition

Table 3. Operating condition

Symbol	Parameter	Min.	Typ.	Max.	Unit
V_{CC}	Supply voltage	4		36	V
V_{icm}	Common mode input voltage range	0		$V_{CC} - 1.5\text{ V}$	V
T_{oper}	Operating temperature range	- 40		125	°C

3 Electrical characteristics

Table 4. Electrical characteristics for $V_{CC+} = 36\text{ V}$, $V_{CC-} = 0\text{ V}$, $V_{icm} = V_{out} = V_{CC}/2$, and $T_{amb} = 25\text{ °C}$ (unless otherwise specified)

Symbol	Parameter	Conditions	Min.	Typ.	Max.	Unit
DC performance						
V _{io}	Input offset voltage		-2.4		2.4	mV
		T _{min} < T < T _{max}	-3		3	
		V _{icm} = V _{cc-}	-2.4		2.4	
ΔV _{io} /ΔT	Input offset voltage drift	T _{min} < T < T _{max}	-8	-2	4	μV/°C
I _{ib}	Input bias current				2	nA
		T _{min} < T < T _{max}			5	
I _{io}	Input offset current				2	nA
		T _{min} < T < T _{max}			5	
CMR	Common mode rejection ratio 20 log (ΔV _{icm} /ΔV _{io})	V _{CC-} ≤ V _{icm} ≤ V _{CC+} - 1.5 V, V _{out} = V _{CC} /2	85	110		dB
		T _{min} < T < T _{max}	81			
SVR	Supply voltage rejection ratio 20 log (ΔV _{cc} /ΔV _{io})	4 V < V _{cc+} - V _{cc-} < 36 V, -40 °C < T < +125 °C	116	130		dB
A _{VD}	Open loop gain	R _L = 10 kΩ, V _{out} = 0.3 to 35.7 V	115	125		
		T _{min} < T < T _{max}	111			
		R _L = 600 Ω, V _{out} = 1 to 35 V	115	125		
V _{OH}	High level output voltage Voltage drop from V _{cc+}	I _{source} = 150 mA		1.2	1.8	V
		T _{min} < T < T _{max}			2	
V _{OL}	Low level output voltage	I _{sink} = 150 mA		1.2	1.8	V
		T _{min} < T < T _{max}			2.2	
I _{CC}	Supply current (per channel)	No load, V _{out} = V _{CC} /2		2.5	3.3	mA
		T _{min} < T < T _{max}			3.5	
I _{OUT} ⁽¹⁾	I _{sink}	V _{out} = V _{cc}	160	200		mA
		T _{min} < T < T _{max}	150			
	I _{source}	V _{out} = 0 V	160	200		
		T _{min} < T < T _{max}	150			
AC performance						
GBP	Gain bandwidth product	R _L = 10 kΩ, C _L = 100 pF		3.1		MHz
φ _m	Phase margin	R _L = 10 kΩ, C _L = 100 pF		60		degrees
G _m	Gain margin	R _L = 10 kΩ, C _L = 100 pF		17		dB
SR	Negative slew rate	Comparator mode, 10% to 90% R _L = 10 kΩ, C _L = 100 pF		2		V/μs
	Positive slew rate	Comparator mode, 10% to 90% R _L = 10 kΩ, C _L = 100 pF		2		
e _n	Equivalent input noise voltage	f = 1 kHz		45		nV/√Hz
		f = 0.1 Hz to 10 Hz		300		μV _{pp}

Symbol	Parameter	Conditions	Min.	Typ.	Max.	Unit
THD+N	Total harmonic distortion + noise	f = 1 kHz, V _{in} = 2 V _{pp} , R _L = 10 kΩ, C _L = 100 pF		0.003		%
	Overload recovery time	100 mV from rail in comparator mode V _{id} = ± 1 V		10		μs
Shutdown						
	Junction temperature	Shutdown		168	180	°C
		Reset from shutdown	130	146		

1. While respecting the maximum junction temperature.

Table 5. Electrical characteristics for $V_{CC+} = 12\text{ V}$, $V_{CC-} = 0\text{ V}$, $V_{icm} = V_{out} = V_{CC}/2$, and $T_{amb} = 25\text{ °C}$ (unless otherwise specified)

Symbol	Parameter	Conditions	Min.	Typ.	Max.	Unit
DC performance						
V_{io}	Input offset voltage		-2.4		2.4	mV
		$T_{min} < T < T_{max}$	-3		3	
		$V_{icm} = V_{CC-}$	-2.4		2.4	
$\Delta V_{io}/\Delta T$	Input offset voltage drift	$T_{min} < T < T_{max}$	-8	-2	4	$\mu\text{V}/\text{°C}$
I_{ib}	Input bias current				2	nA
		$T_{min} < T < T_{max}$			5	
I_{io}	Input offset current				2	nA
		$T_{min} < T < T_{max}$			5	
CMR	Common mode rejection ratio 20 log ($\Delta V_{icm}/\Delta V_{io}$)	$V_{CC-} \leq V_{ICM} \leq V_{CC+} - 1.5\text{ V}$, $V_{out} = V_{CC}/2$	75	100		dB
		$T_{min} < T < T_{max}$	70			
SVR	Supply voltage rejection ratio 20 log ($\Delta V_{icm}/\Delta V_{io}$)	$4\text{ V} < V_{CC+} - V_{CC-} < 36\text{ V}$, $-40\text{ °C} < T < +125\text{ °C}$	116	130		dB
A_{VD}	Open loop gain	$R_L = 10\text{ k}\Omega$, $V_{out} = 0.3\text{ to }11.7\text{ V}$	110	125		
		$T_{min} < T < T_{max}$	101			
		$R_L = 600\ \Omega$, $V_{out} = 1\text{ to }11\text{ V}$	110	125		
		$T_{min} < T < T_{max}$	101			
V_{OH}	High level output voltage. Voltage drop from V_{CC+}	$I_{source} = 150\text{ mA}$		1.2	1.8	V
		$T_{min} < T < T_{max}$			2	
V_{OL}	Low level output voltage	$I_{sink} = 150\text{ mA}$		1.2	1.8	V
		$T_{min} < T < T_{max}$			2.2	
I_{CC}	Supply current (per channel)	No load, $V_{out} = V_{CC}/2$		2.3	3	mA
		$T_{min} < T < T_{max}$			3.4	
$I_{OUT}^{(1)}$	I_{sink}	$V_{out} = V_{CC}$	160			mA
		$T_{min} < T < T_{max}$	150			
	I_{source}	$V_{out} = 0\text{ V}$	160			
		$T_{min} < T < T_{max}$	150			
AC performance						
GBP	Gain bandwidth product	$R_L = 10\text{ k}\Omega$, $C_L = 100\text{ pF}$		3		MHz
ϕ_m	Phase margin	$R_L = 10\text{ k}\Omega$, $C_L = 100\text{ pF}$		60		degrees
Gm	Gain margin	$R_L = 10\text{ k}\Omega$, $C_L = 100\text{ pF}$		17		dB
SR	Negative slew rate	Comparator mode, 10% to 90% $R_L = 10\text{ k}\Omega$, $C_L = 100\text{ pF}$		1.9		V/ μs
	Positive slew rate	Comparator mode, 10% to 90% $R_L = 10\text{ k}\Omega$, $C_L = 100\text{ pF}$		1.9		
en	Equivalent input noise voltage	$f = 1\text{ kHz}$		45		nV/ $\sqrt{\text{Hz}}$
		$f = 0.1\text{ Hz to }10\text{ Hz}$		300		μVpp
THD+N	Total harmonic distortion + noise	$f = 1\text{ kHz}$, $V_{in} = 2\text{ Vpp}$, $R_L = 10\text{ k}\Omega$, $C_L = 100\text{ pF}$		0.005		%

Symbol	Parameter	Conditions	Min.	Typ.	Max.	Unit
	Overload recovery time	100 mV from rail in comparator mode $V_{id} = \pm 1\text{ V}$		10		μs
Shutdown						
	Junction temperature	Shutdown		168	180	$^{\circ}\text{C}$
		Reset from shutdown	130	146		

1. While respecting the maximum junction temperature.

Table 6. Electrical characteristics for $V_{CC+} = 5\text{ V}$, $V_{CC-} = 0\text{ V}$, $V_{ICM} = V_{out} = V_{CC}/2$, and $T_{amb} = 25\text{ °C}$ (unless otherwise specified).

Symbol	Parameter	Conditions	Min.	Typ.	Max.	Unit
DC performance						
V_{io}	Input offset voltage		-2.4		2.4	mV
		$T_{min} < T < T_{max}$	-3		3	
		$V_{ICM} = V_{CC-}$	-2.4		2.4	
$\Delta V_{io}/\Delta T$	Input offset voltage drift	$T_{min} < T < T_{max}$	-8	-2	4	$\mu\text{V}/\text{°C}$
I_{ib}	Input bias current				2	nA
		$T_{min} < T < T_{max}$			5	
I_{io}	Input offset current				2	nA
		$T_{min} < T < T_{max}$			5	
CMR	Common mode rejection ratio $20 \log(\Delta V_{ICM}/\Delta V_{io})$	$V_{CC-} \leq V_{ICM} \leq V_{CC+} - 1.5\text{ V}$, $V_{out} = V_{CC}/2$	65	90		dB
		$T_{min} < T < T_{max}$	60			
SVR	Supply voltage rejection ratio $20 \log(\Delta V_{CC}/\Delta V_{io})$	$4\text{ V} < V_{CC+} - V_{CC-} < 36\text{ V}$, $-40\text{ °C} < T < 125\text{ °C}$	116	130		dB
A_{VD}	Open loop gain	$R_L = 10\text{ k}\Omega$, $V_{out} = 0.3\text{ to }4.7\text{ V}$	100	120		
		$T_{min} < T < T_{max}$	98			
		$R_L = 600\ \Omega$, $V_{out} = 1\text{ to }4\text{ V}$	100	115		
		$T_{min} < T < T_{max}$	98			
V_{OH}	High level output voltage Voltage drop from V_{CC+}	$I_{source} = 150\text{ mA}$		1.2	1.8	V
		$T_{min} < T < T_{max}$			2	
V_{OL}	Low level output voltage	$I_{sink} = 150\text{ mA}$		1.2	1.8	V
		$T_{min} < T < T_{max}$			2.2	
I_{CC}	Supply current (per channel)	No load, $V_{out} = V_{CC}/2$		2.3	3	mA
		$T_{min} < T < T_{max}$			3.4	
$I_{OUT}^{(1)}$	I_{sink}	$V_{out} = V_{CC}$	160			mA
		$T_{min} < T < T_{max}$	150			
	I_{source}	$V_{out} = 0\text{ V}$	160			
		$T_{min} < T < T_{max}$	150			
AC performance						
GBP	Gain bandwidth product	$R_L = 10\text{ k}\Omega$, $C_L = 100\text{ pF}$		2.7		MHz
ϕ_m	Phase margin	$R_L = 10\text{ k}\Omega$, $C_L = 100\text{ pF}$		60		degrees
Gm	Gain margin	$R_L = 10\text{ k}\Omega$, $C_L = 100\text{ pF}$		17		dB
SR	Negative slew rate	Comparator mode, 10% to 90% $R_L = 10\text{ k}\Omega$, $C_L = 100\text{ pF}$		1.7		V/ μs
	Positive slew rate	Comparator mode, 10% to 90% $R_L = 10\text{ k}\Omega$, $C_L = 100\text{ pF}$		1.7		
en	Equivalent input noise voltage	$f = 1\text{ kHz}$		45		$\text{nV}/\sqrt{\text{Hz}}$
		$f = 0.1\text{ Hz to }10\text{ Hz}$		300		μV_{pp}
THD+N	Total harmonic distortion + noise	$f = 1\text{ kHz}$, $V_{in} = 2\text{ V}_{pp}$, $R_L = 10\text{ k}\Omega$, $C_L = 100\text{ pF}$		0.007		%

Symbol	Parameter	Conditions	Min.	Typ.	Max.	Unit
	Overload recovery time	100 mV from rail in comparator mode $V_{id} = \pm 1 \text{ V}$		10		μs
Shutdown						
	Junction temperature	Shutdown		168	180	$^{\circ}\text{C}$
		Reset from shutdown	130	146		

1. While respecting the maximum junction temperature.

4 Typical performance characteristics

R_L connected to $V_{CC}/2$ (unless otherwise specified).

Figure 2. Supply current vs. supply voltage (per channel)

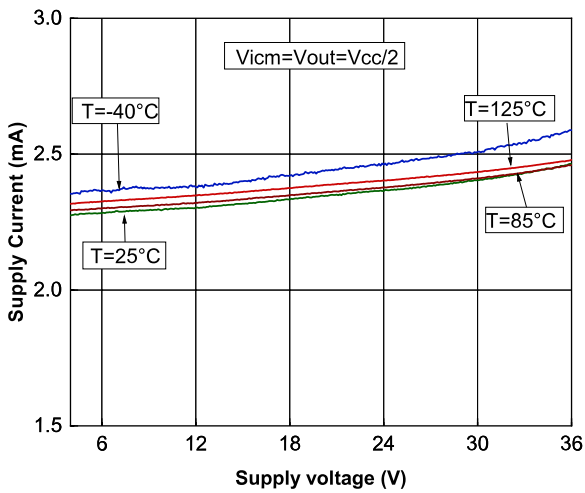
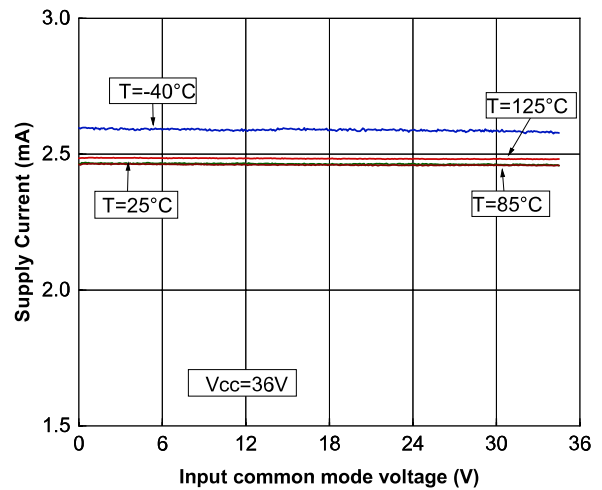

Figure 3. Supply current vs. input common mode voltage per channel ($V_{CC} = 36\text{ V}$)



**Figure 4. Input offset voltage distribution, $T = 25^\circ\text{C}$
 $V_{CC} = 12\text{ V}$**

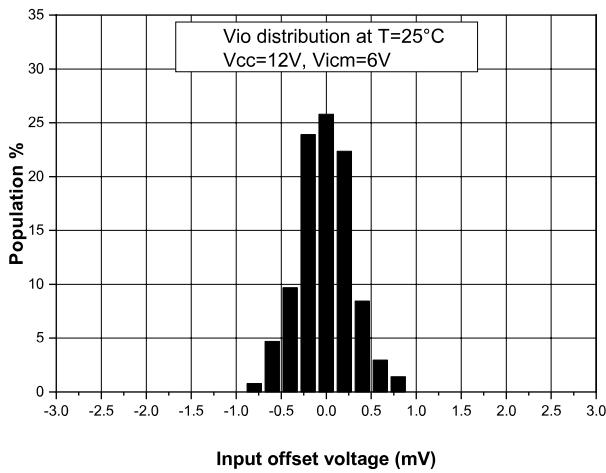

Figure 5. Input offset voltage temperature coefficient distribution from -40°C to 25°C ($\mu\text{V}/^\circ\text{C}$), $V_{CC} = 12\text{ V}$

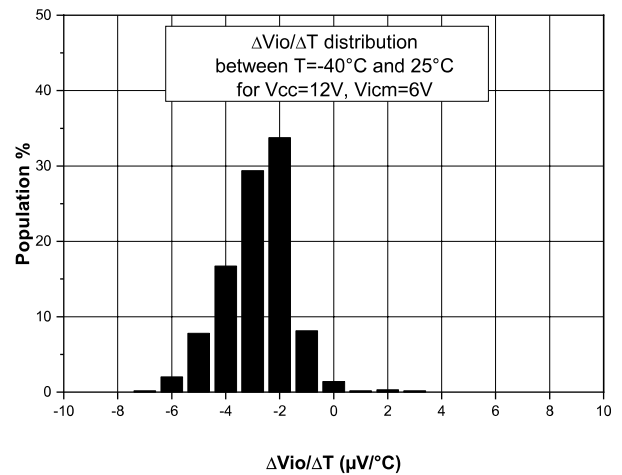

Figure 6. Input offset voltage temperature coefficient distribution from 25 °C to 125 °C ($\mu\text{V}/^\circ\text{C}$), $V_{CC} = 12\text{ V}$

Figure 7. Input offset voltage vs. supply voltage

Figure 8. Input offset voltage vs. input common mode voltage $V_{CC} = 36\text{ V}$

Figure 9. Input bias current vs. temperature at mid V_{ICM}

Figure 10. Output voltage drop vs. output current load, $V_{CC} = 36\text{ V}$, $V_{icm} = V_{CC}/2$, $V_{id} = -1\text{ V}$ for sink, $+1\text{ V}$ for source

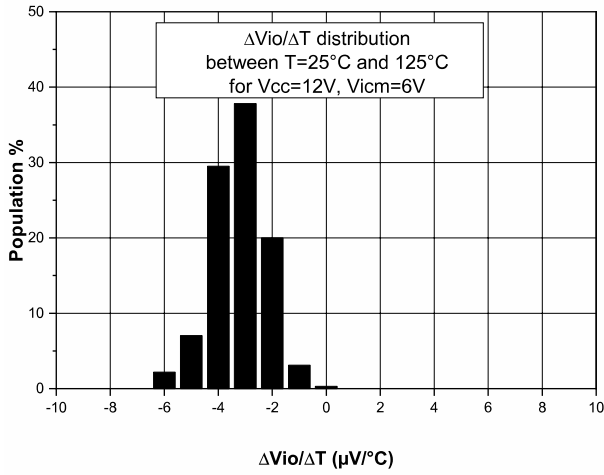
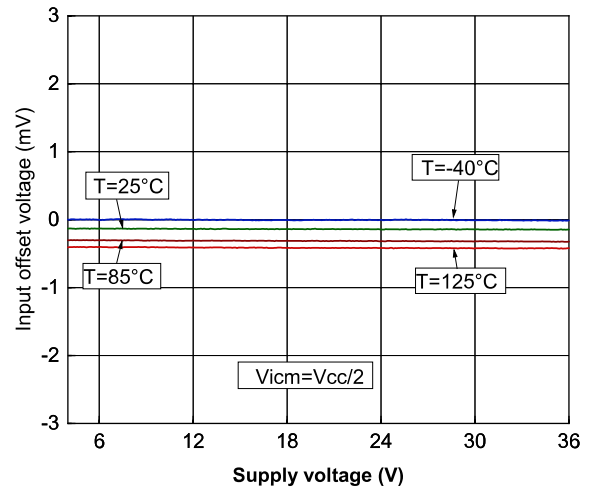
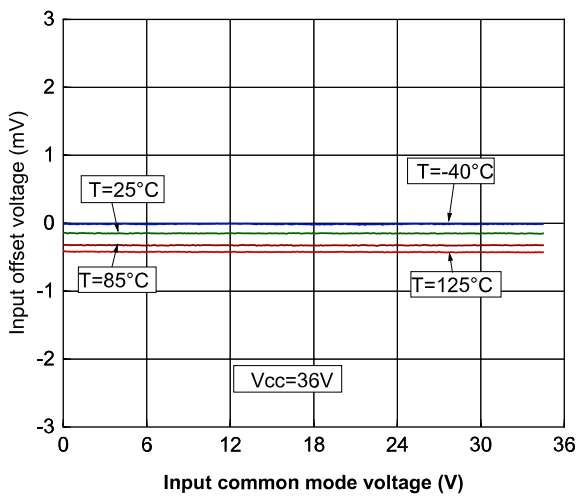
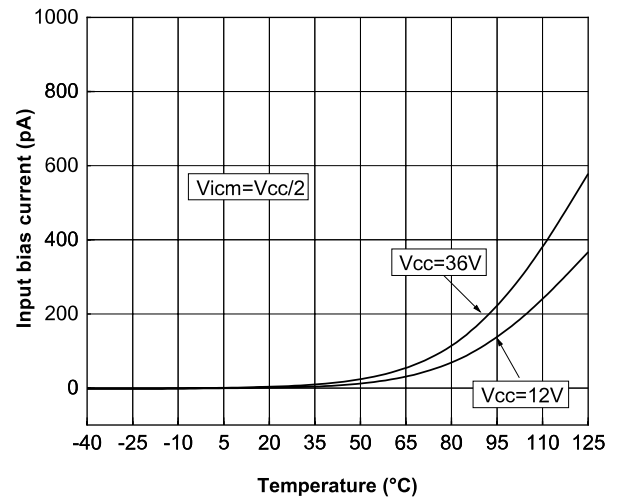
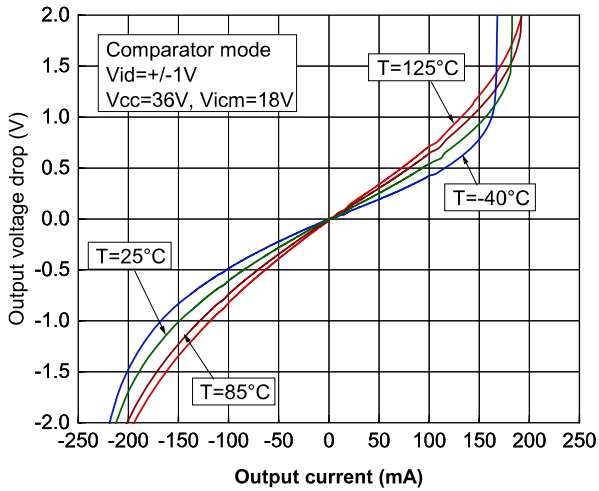

Figure 11. High-level output voltage (drop from V_{CC+}) vs. V_{CC} , $I_{load} = 160\text{ mA}$

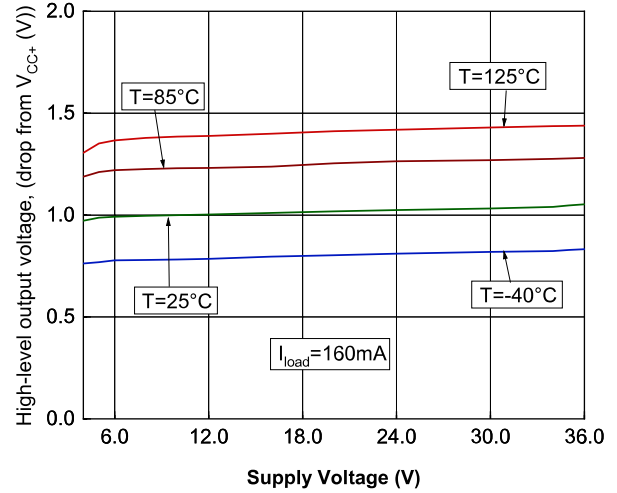

Figure 12. High-level output voltage, (drop from V_{CC+}) vs. temperature, $I_{load} = 160\text{ mA}$

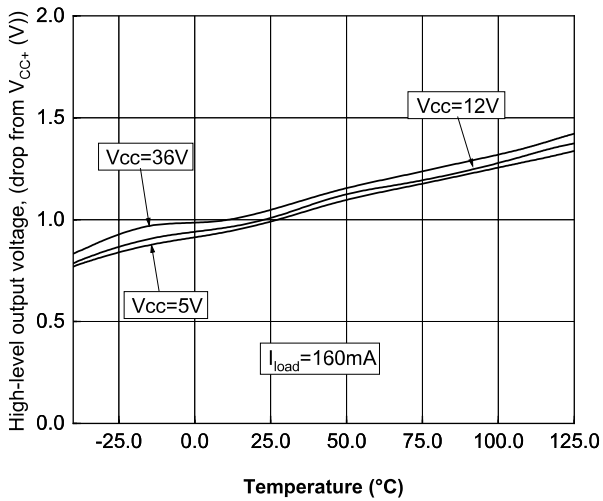

Figure 13. Low-level output voltage vs. V_{CC} , $I_{load} = 160\text{ mA}$

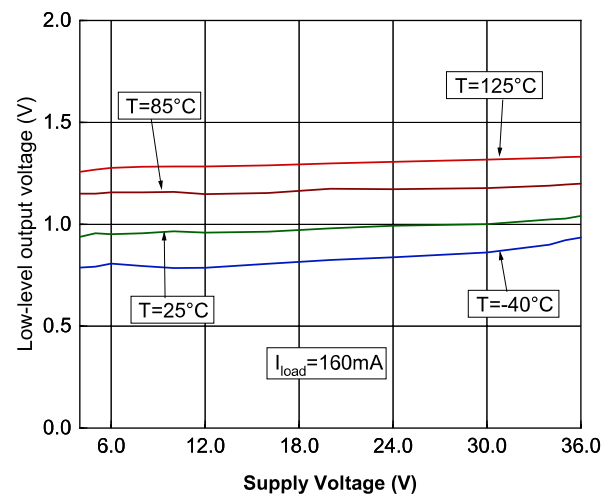

Figure 14. Low-level output voltage vs. temperature, $I_{load} = 160 \text{ mA}$

Figure 15. Slew rate vs. V_{cc} , $R_{load} = 10 \text{ k}\Omega$, $C_{load} = 100 \text{ pF}$, comparator mode, $V_{diff} = 5 \text{ V}$

Figure 16. Small signal response at 36 V supply voltage

Figure 17. Bode Diagram, $V_{cc} = 36 \text{ V}$, $R_l = 10 \text{ k}\Omega$, $C_{load} = 100 \text{ pF}$, common mode voltage = 18 V

Figure 18. Unity gain frequency vs. temperature, $V_{CC} = 36\text{ V}$, $R_I = 10\text{ k}\Omega$

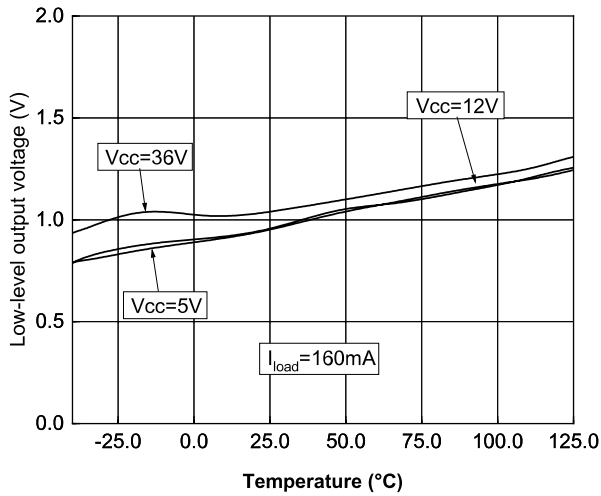
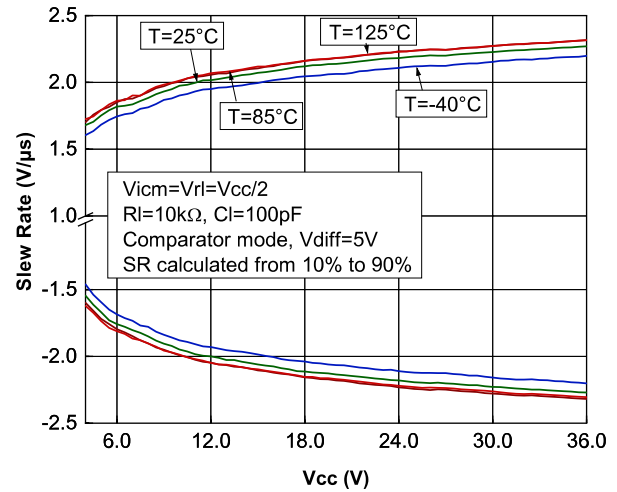
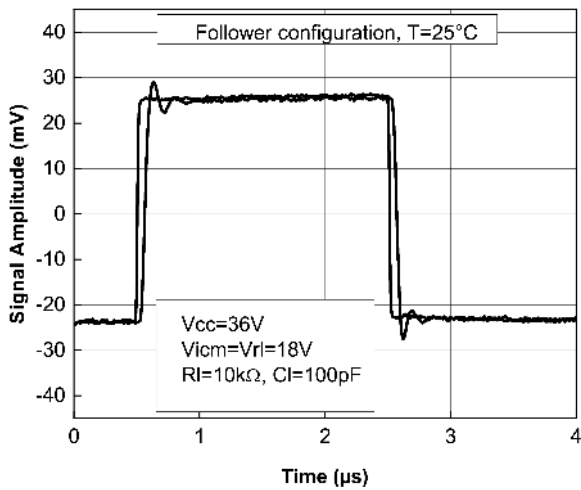
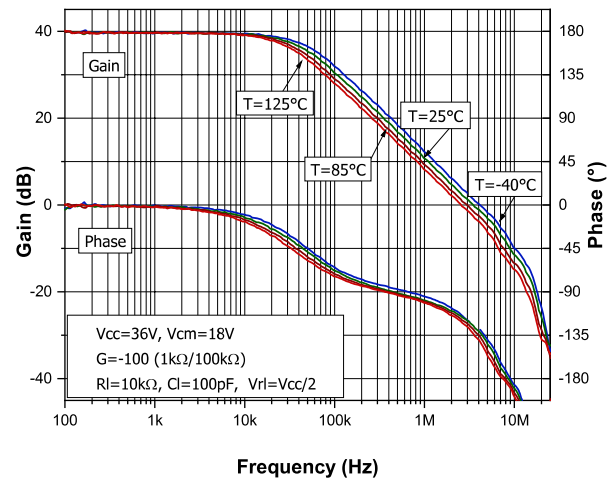
Figure 19. Phase margin vs. capacitive load $V_{CC} = 36\text{ V}$, $R_I = 10\text{ k}\Omega$

Figure 20. Gain margin vs. capacitive load $V_{CC} = 36\text{ V}$, $R_I = 10\text{ k}\Omega$

Figure 21. Overshoot vs. capacitive load

Figure 22. Noise vs. frequency for different supply voltages

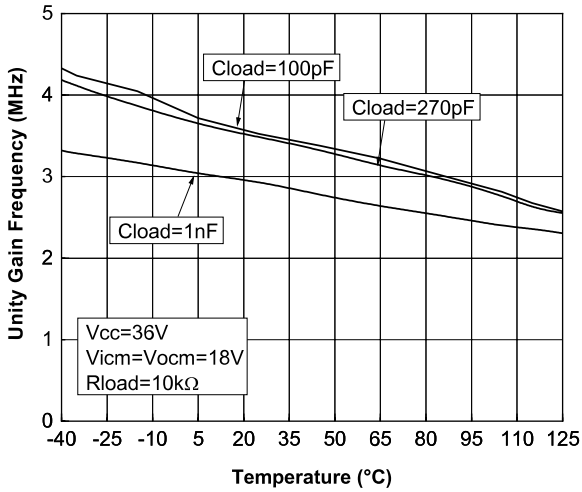
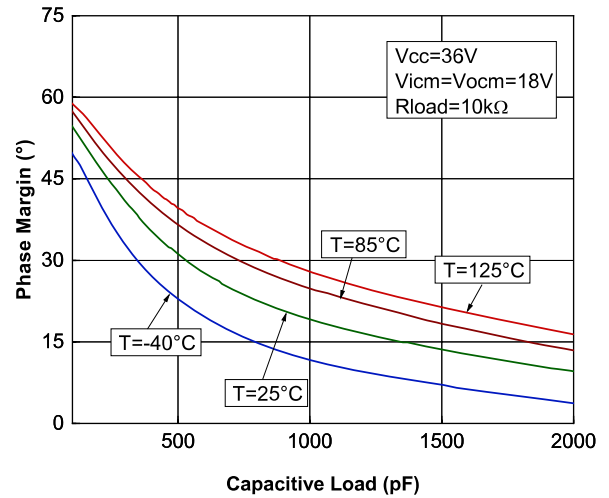
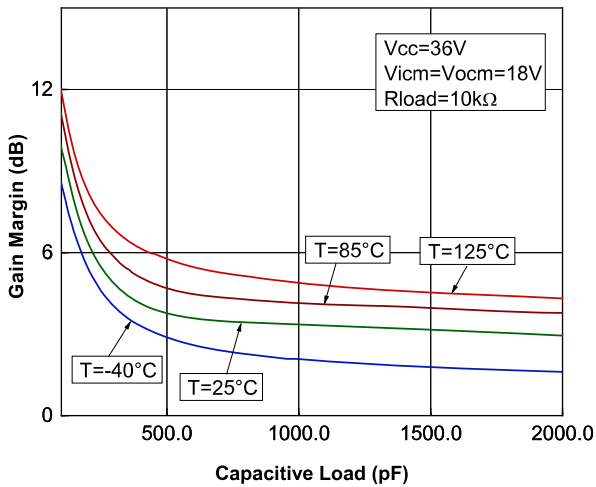
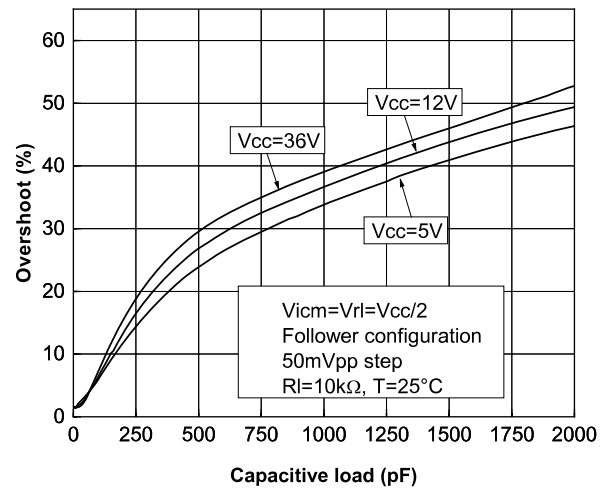
Figure 23. THD vs. Output voltage swing for different frequencies, $V_{CC} = 36\text{ V}$, $R_I = 10\text{ k}\Omega$, $C_I = 100\text{ pF}$

Figure 24. THD vs. frequency for different V_{cm} , $V_{CC} = 36\text{ V}$, $V_{icm} = V_{ocm} = V_{cm}$, $R_I = 10\text{ k}\Omega$, $C_I = 100\text{ pF}$

Figure 25. PSRR vs. frequency

Figure 26. Channel separation vs. frequency

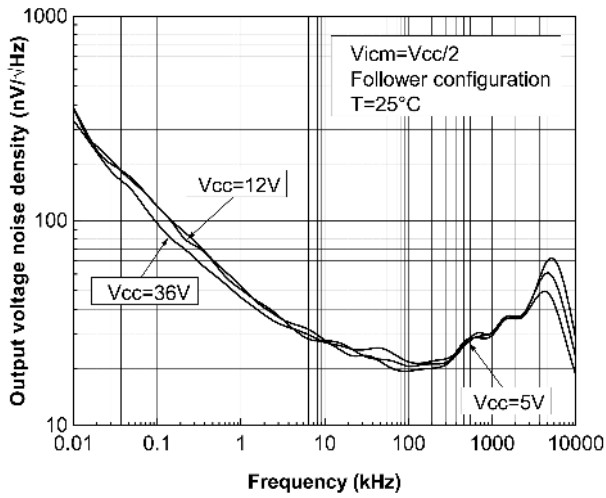
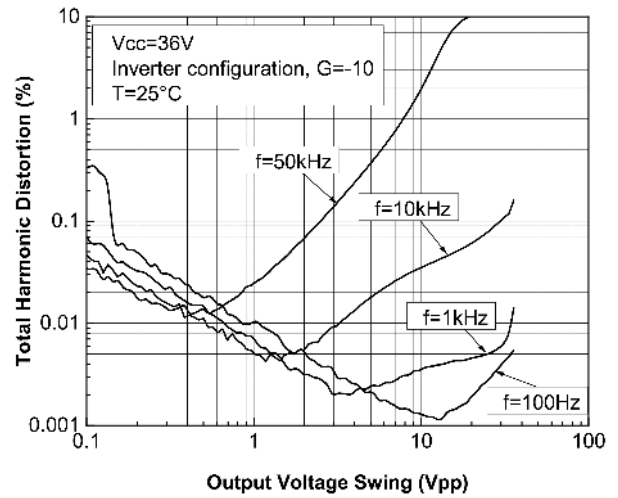
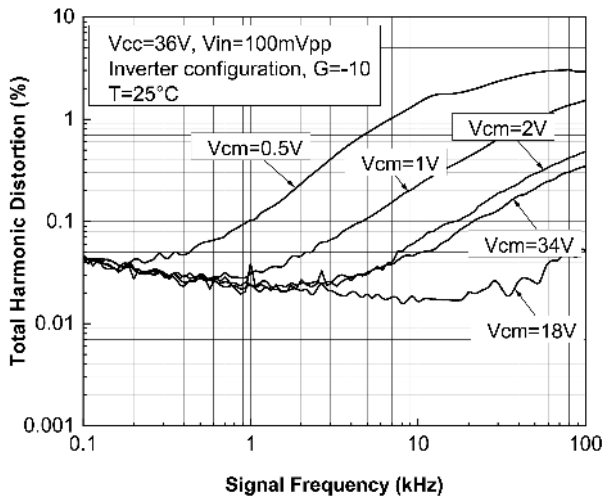
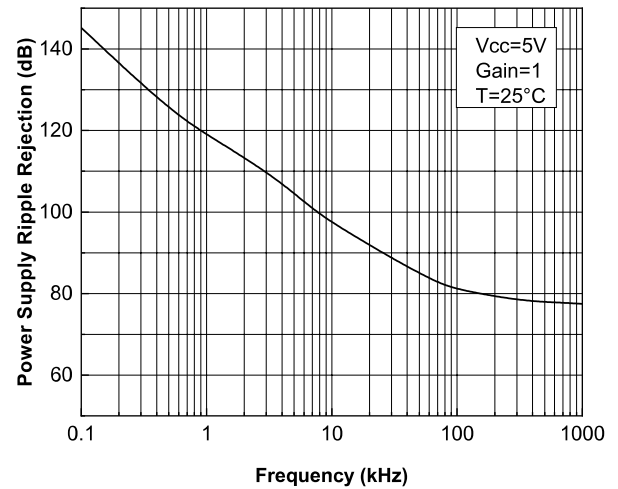
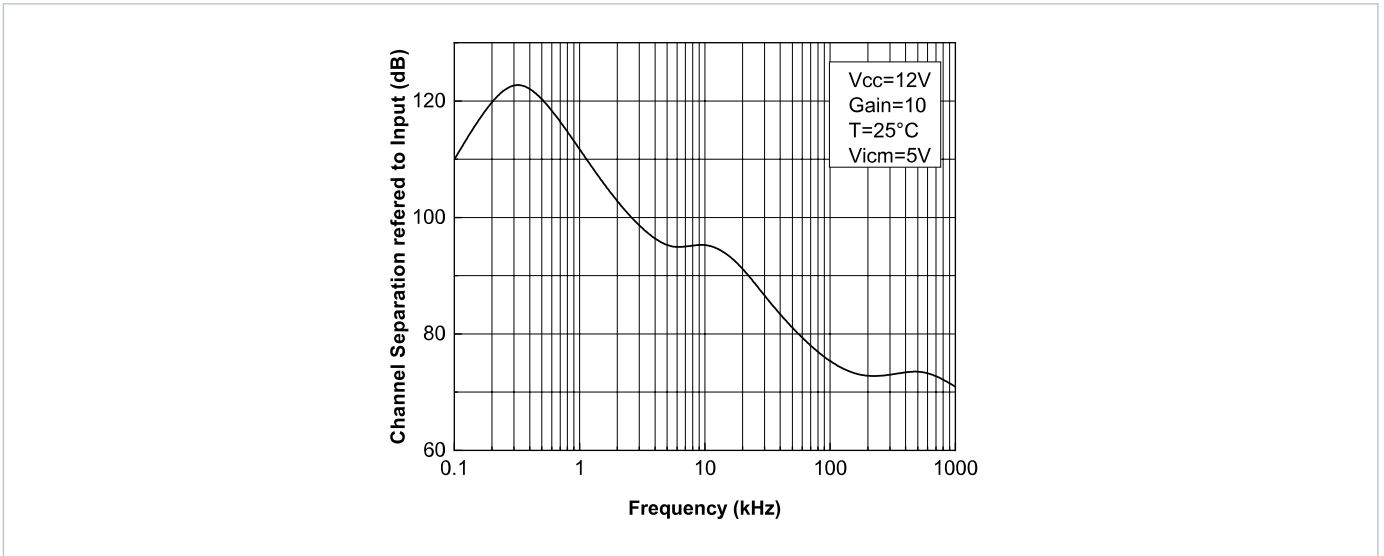
5 Application information

5.1 Operating voltages

The TSB582 can operate from 4 to 36 V. The parameters are fully specified at 5 V, 12 V and 36 V power supplies. However, the parameters are very stable over the full VCC range and several characterization curves show the TSB582 device characteristics over the full operating range. Additionally, the main specifications are guaranteed in extended temperature range from -40 to 125 °C.

5.2 ESD and input protection

Figure 27 illustrates an equivalent circuit of the TSB582's protection against ESD events and high differential input voltages. The TSB582 is designed for input common mode voltages ranging from the low rail up to $V_{CC} - 1.5$ V with input currents I_{in} that must not exceed 27 mA. Input resistors in combination with a voltage limitation prevent excessive differential voltages from damaging the differential input stage of the operational amplifier. However, note that differential input voltages of more than $V_{id} = 1.3$ V (typical) cause a non-negligible current flow through the input protection stage that might be considered when calculating the thermal budget of the amplifier. A high input current in comparator mode might also impact the input signal at application level. In case the differential input voltage of the application should exceed the absolute maximum rating of $V_{id} = \pm 42$ V, it is recommended to add external resistors to the design to keep the maximum current below $I_{in} = 27$ mA.

Figure 27. Equivalent internal ESD and input protection circuit

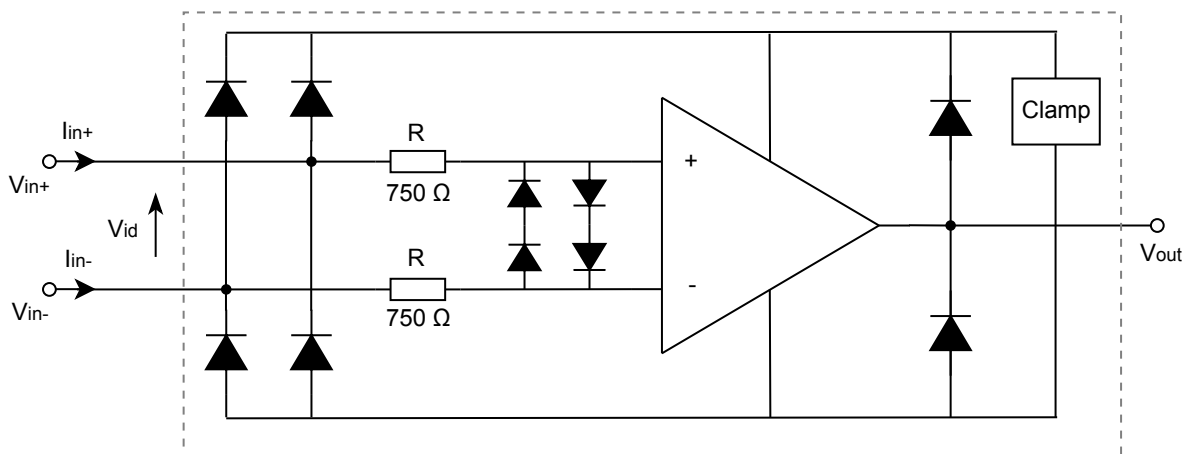

5.3 EMI rejection

The electromagnetic interference (EMI) rejection ratio, or EMIRR, describes the EMI immunity of operational amplifiers. An adverse effect that is common to many op amps is a change in the offset voltage as a result of RF signal rectification. EMIRR is defined as follows:

$$EMIRR = 20 \cdot \log \left(\frac{V_{inpp}}{\Delta V_{io}} \right) \quad (1)$$

The TSB582 has been specially designed to minimize susceptibility to EMIRR and shows a low sensitivity. As visible in the figure below, the EMI rejection ratio has been measured on both inputs and outputs, from 10 MHz to 2.4 GHz.

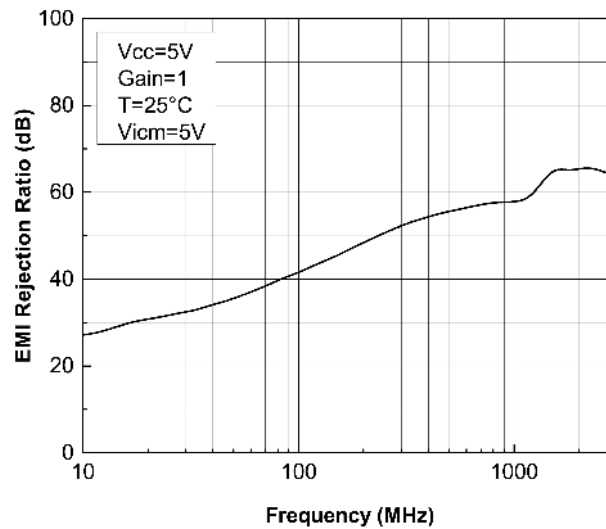
Figure 28. EMI rejection ratio vs. frequency

EMIRR performance might be improved by adding small capacitances (in the pF range) on the inputs, power supply, and output pins. These capacitances help in minimizing the impedance of these nodes at high frequencies.

5.4 Input offset voltage drift versus temperature

The maximum input voltage drift overtemperature is defined as the offset variation related to the offset value measured at 25 °C. The operational amplifier is one of the main circuits of the signal conditioning chain, and the amplifier input offset (V_{io}) is a major contributor to the chain accuracy. The signal chain accuracy at 25 °C can be compensated during production at application level. The maximum input voltage drift overtemperature enables the system designer to anticipate the effect of temperature variations. The maximum input voltage drift overtemperature is computed using Equation:

$$\frac{\Delta V_{io}}{\Delta T} = \max \left| \frac{V_{io}(T) - V_{io}(25^{\circ}\text{C})}{T - 25^{\circ}\text{C}} \right|_{T = -40^{\circ}\text{C to } T = 125^{\circ}\text{C}} \quad (2)$$

The datasheet maximum value is guaranteed by a measurement on a representative sample size ensuring a C_{pk} (process capability index) greater than 1.3.

5.5 Maximum power dissipation

The usable output load current drive is limited by the maximum power dissipation allowed by the device package. The absolute maximum junction temperature for the TSB582 is 150 °C. The junction temperature can be estimated as follows:

$$T_j = P_d \times R_{thja} + T_a \quad (3)$$

T_j is the die junction temperature

P_d is the power dissipated in the package

R_{thja} is the junction to ambient thermal resistance of the package

T_a is the ambient temperature

The power dissipated in the package P_d is the sum of three main sources of both amplifier channels. The quiescent power, the power dissipated by the output stage transistor, and the input protection circuit in case the differential input voltage is forced to $|V_{id}| > 1.3\text{ V}$ (see [Section 5.2 ESD and input protection](#)). It is calculated as follows.

$$P_d = P_{d_amp1} + P_{d_amp2} \quad (4)$$

$$P_{d_amp} = V_{cc} \times I_{cc} + (V_{cc} + -V_{out}) \times I_{load} + \left[\frac{(|V_{id}| - 1.3\text{V}) \times |V_{id}|}{1.5\text{k}\Omega} \right] \text{ if } |V_{id}| > 1.3\text{V} \quad (5)$$

when the op amp sources the current.

$$P_{d_amp} = V_{cc} \times I_{cc} + (V_{out} - V_{cc-}) \times I_{load} + \left[\frac{(|V_{id}| - 1.3V) \times |V_{id}|}{1.5k\Omega} \right] \text{ if } |V_{id}| > 1.3V \quad (6)$$

when the op amp sinks the current.

Do not exceed the 150 °C maximum junction temperature for the device. Exceeding the junction temperature limit can cause degradation in the parametric performance or even destroy the device.

5.6 Thermal shutdown considerations

To guarantee proper operation, precautions must be taken to keep the device die temperature below the maximum junction temperature. This is achieved by computing the dissipated power in the device and using a large enough copper area or heatsink on the PCB to reduce the thermal resistance between the device and its ambient.

To protect the device, a thermal shutdown mechanism is implemented:

- A thermal sensor continuously measures the average die temperature
- If the temperature goes above a high threshold, the output power stage is turned OFF to allow the device to cool down
- When the temperature goes back below a low threshold, the output power stage is turned ON again

This safety behavior prevents the die from reaching a destructive temperature. Nevertheless, the device is not intended to continuously operate in such a condition. The application shall thus be designed with consideration to the maximum dissipated power and maximum temperature to keep the die below the thermal shutdown temperature threshold. When safe operating conditions cannot be guaranteed, external protection such as PTC or fuses shall be used.

5.7 Safe operating area

Figure 29 and Figure 30 show the typical safe operating area (SOA) of the TSB582, where one amplifier is in load condition whereas the second one stays in idle mode without load. Depending on the intended application, the total power dissipation might be split over the two amplifiers. In case both amplifiers are used simultaneously, or the differential input voltage is forced to continuously exceed $|V_{id}| = 1.3\text{ V}$, a calculation of the junction temperature based on the total power dissipation is recommended, as demonstrated in [Section 5.5 Maximum power dissipation](#).

Figure 29. SO8 safe operating area, one channel active

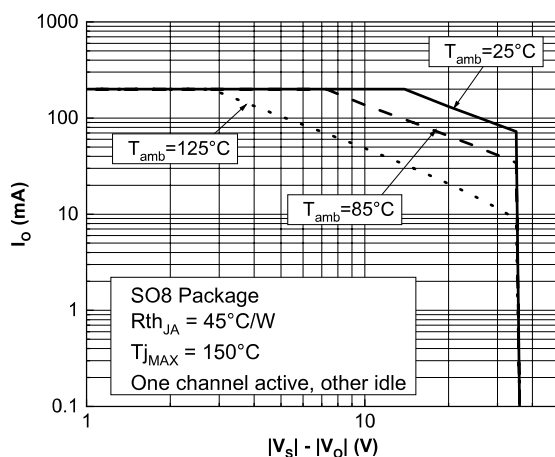
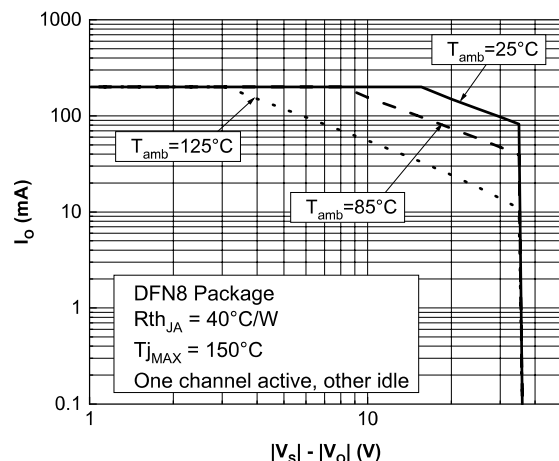

Figure 30. DFN8 safe operating area, one channel active



5.8 Capacitive load and stability

Stability analysis must be performed for large capacitive loads over 100 pF. Increasing the load capacitance to high values produces gain peaking in the frequency response, with overshoot and ringing in the step response. Generally, unity gain configuration is the worst situation for stability and the ability to drive large capacitive loads. For additional capacitive load drive capability in unity-gain configuration, stability can be improved by inserting a small resistor R_{ISO} (10 Ω to 30 Ω) in series with the output. This resistor significantly reduces ringing while maintaining DC performance for purely capacitive loads. However, if there is a resistive load in parallel with the capacitive load, a voltage divider is created introducing a gain error on the output and slightly reducing the output swing. The error introduced is proportional to the ratio R_{ISO} / R_L . R_{ISO} modifies the maximum capacitive load acceptable from a stability point-of-view as described in the following figure:

Figure 31. Stability criteria with a serial resistor at different capacitive loads

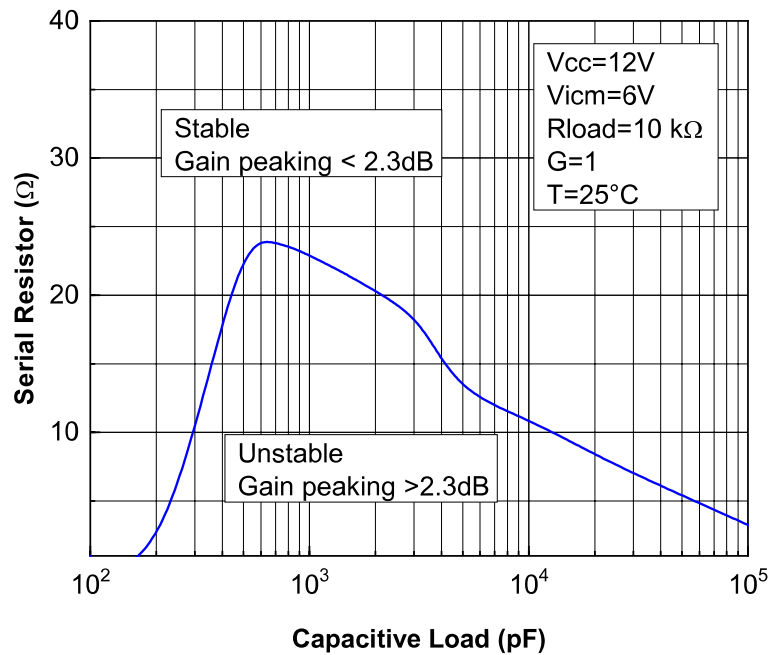
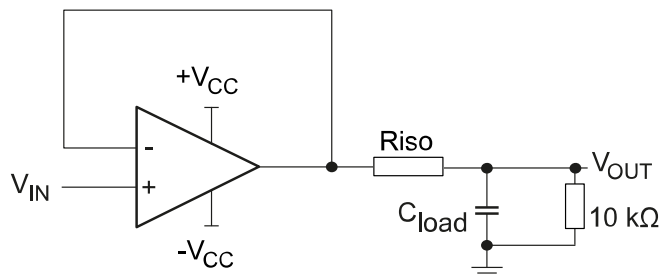

Figure 32. Test configuration for R_{ISO}



Please note that $R_{ISO} = 30 \Omega$ is sufficient to make the TSB512 stable whatever the capacitive load. However, for high output currents, voltage drops across R_{ISO} should be considered.

5.9 PCB layout recommendations

Particular attention must be paid to the layout of the PCB tracks connected to the amplifier, load, and power supply. The power and ground traces are critical as they must provide adequate energy and grounding for all circuits. The best practice is to use short and wide PCB traces to minimize voltage drops and parasitic inductance. In addition, to minimize parasitic impedance over the entire surface, a multi-via technique that connects the bottom and top layer ground planes together in many locations is often used. The copper traces connecting the output pins to the load and supply pins should be as wide as possible to minimize trace resistance.

5.10 Decoupling capacitor

In order to ensure op amp full functionality, it is mandatory to place a decoupling capacitor of at least 22 nF as close as possible to the op amp supply pin. A good decoupling helps to reduce electromagnetic interference impact.

6 Typical applications

6.1 Rotary resolver

In closed-loop motor control systems, a preferred way to read out the shaft's angular position is the rotary resolver. It essentially exists of one primary reference winding plus two secondary windings, the sin- and cos-winding in the stator. Since the primary winding is typically powered through a rotary transformer, no brushes or rings are needed. This increases the overall reliability and robustness of the resolver and makes it perfectly suitable for harsh environments with varying temperature and in oily, dusty, or humid surroundings.

Closed-loop motor control systems help to navigate factory robots and to maneuver vehicles in autonomous parking mode. The TSB582 manages the power amplification to pilot the primary winding of a resolver device as can be seen in Figure 33.

6.2 Design requirements

The shown schematic essentially takes a low voltage sinusoidal input signal with 3.3 V peak-to-peak at 1 kHz to 20 kHz and transforms it into a differential output of 24 V peak-to-peak with high current capability to drive the primary winding of a resolver in bridged mode.

Figure 33. Rotary resolver excitation amplifier

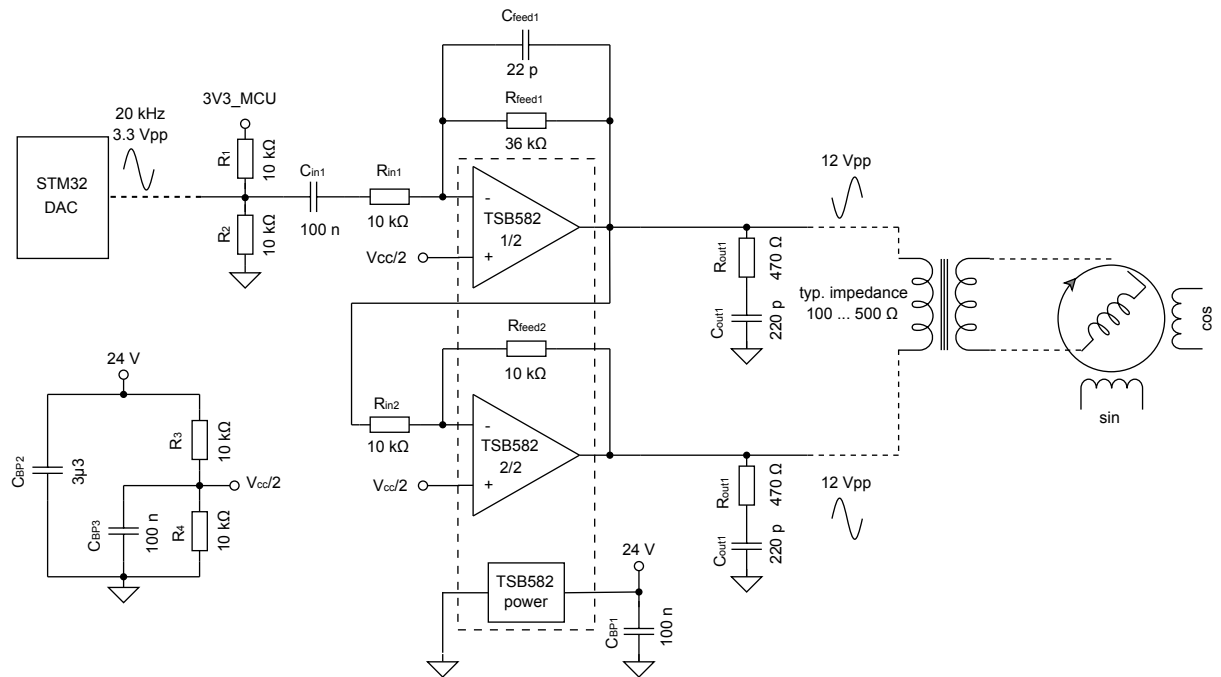

The gain resistance should be adapted to the desired input / output voltage levels:

$$A_V = \frac{V_{out}}{V_{in}} = \frac{12 V_{pp}}{3.3 V_{pp}} = 3.63 \quad (7)$$

$$R_{feed1} = A_V \cdot R_{in1} = 3.63 \cdot 10 k\Omega = 36.36 k\Omega \approx 36 k\Omega \quad (8)$$

$$\left(A_{V_{final}} = 3.6, \text{ error} = 1.01 \% \right) \quad (9)$$

6.3 Increasing output current

To increase the output currents up to 400 mA, the two operational amplifiers can be tied in parallel, as shown in Figure 34. The output resistors R_S prevent differential current flow between the output stages of the two operational amplifiers due to deviations in V_{i0} . Care must be taken when selecting R_S , since they introduce a non-negligible voltage drop to the design at high currents.

Figure 34. Increasing output current

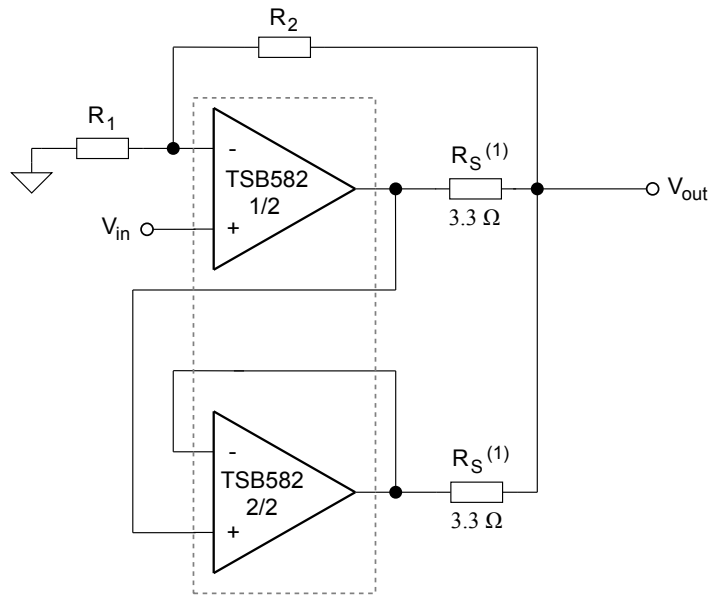

7 Package information

In order to meet environmental requirements, ST offers these devices in different grades of **ECOPACK** packages, depending on their level of environmental compliance. ECOPACK specifications, grade definitions and product status are available at: www.st.com. ECOPACK is an ST trademark.

7.1 SO8 exposed pad package information

Figure 35. SO8 exposed pad package outline

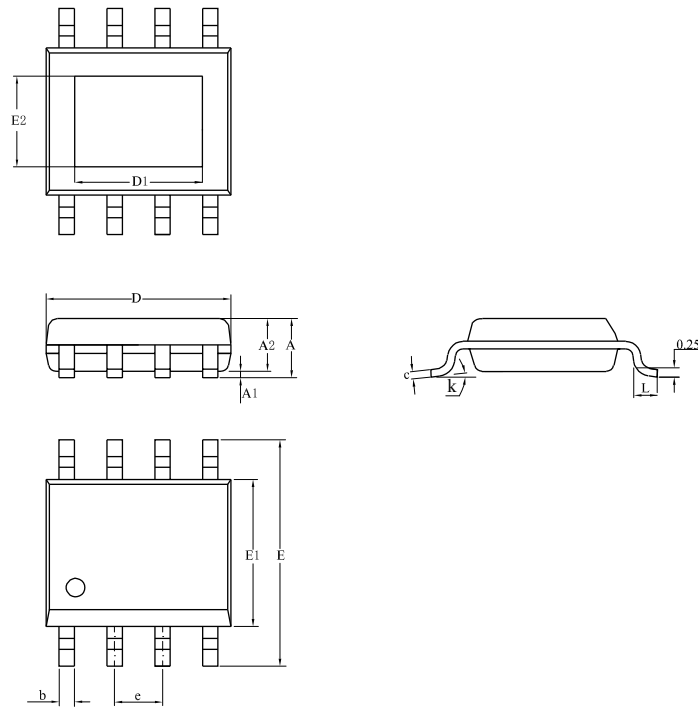
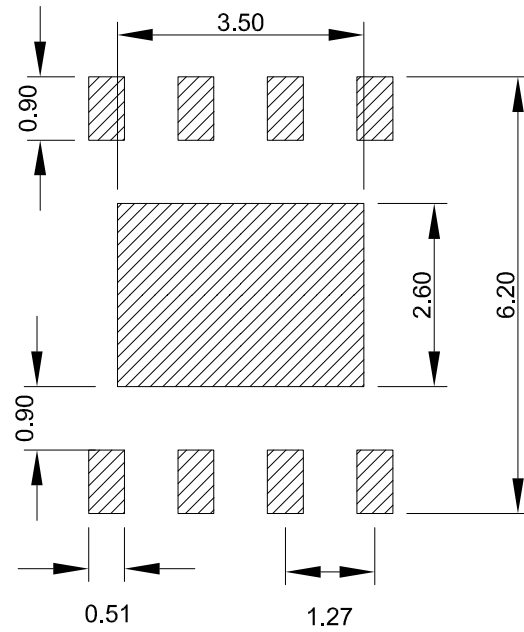

Table 7. SO8 exposed pad mechanical data

Symbol	Dimensions (mm)		
	Min.	Typ.	Max.
A			1.70
A1	0.00		0.15
A2	1.25		
b	0.31		0.51
c	0.17		0.25
D ⁽¹⁾	4.80	4.90	5.00
D1		2.09	
E	5.80	6.00	6.20
E1 ⁽²⁾	3.80	3.90	4.00
E2		2.09	
e		1.27	
L	0.40		1.27
k	0°		8°

1. Dimension "D" does not include mold flash, protrusions or gate burrs. Mold flash, protrusions or gate burrs shall not exceed 0.15 mm in total (both side).
2. Dimension "E1" does not include interlead flash or protrusions. Interlead flash or protrusions shall not exceed 0.25 mm per side.

Figure 36. SO8 exposed pad footprint data



7.2 DFN8 3x3 exposed pad, wettable flank package information

Figure 37. DFN8 3x3 exposed pad, wettable flank package outline and mechanical data

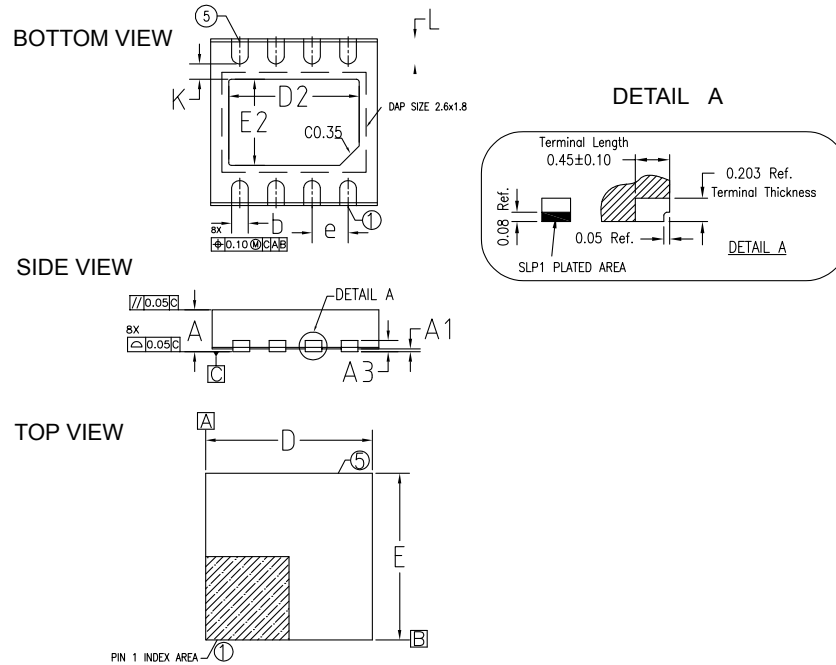
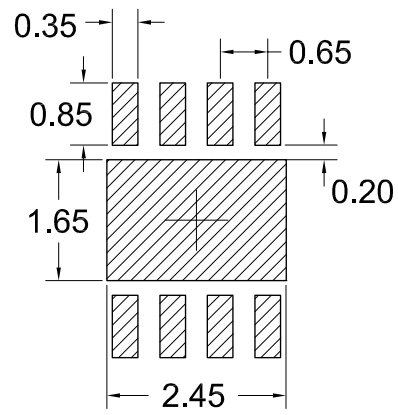

Table 8. DFN8 3x3 exposed pad, wettable flank mechanical data

Symbol	mm		
	Min.	Typ.	Max.
A	0.70	0.75	0.80
A1	0.0		0.05
A3		0.20 Ref.	
b	0.25	0.30	0.35
D	2.95	3.00	3.05
D2	2.25	2.35	2.45
e		0.65 BSC	
E	2.95	3.00	3.05
E2	1.45	1.55	1.65
L	0.35	0.45	0.55
K		0.275 Ref.	
N		8	

Figure 38. DFN8 3x3 exposed pad, wettable flank footprint data

8 Ordering information

Table 9. Order codes

Order code	Temperature range	Package	Packing	Marking
TSB582IDT	-40 °C to +125 °C	SO8 exposed pad	Tape and reel	K2H
TSB582IYDT ⁽¹⁾				K2I
TSB582IQ2T		DFN8 exposed pad		K2H
TSB582IYQ2T ⁽¹⁾				K2I

1. Qualified and characterized according to AEC Q100 and Q003 or equivalent, advanced screening according to AEC Q001 & Q002 or equivalent.

Revision history

Table 10. Document revision history

Date	Revision	Changes
22-Apr-2022	1	Initial release.
05-Aug-2022	2	Updated title and features on the cover page. Added exposed pad information in Table 1 .

Contents

1	Pin configuration	2
2	Maximum ratings	3
2.1	Operating condition	3
3	Electrical characteristics	4
4	Typical performance characteristics	10
5	Application information	17
5.1	Operating voltages	17
5.2	ESD and input protection	17
5.3	EMI rejection	17
5.4	Input offset voltage drift versus temperature	18
5.5	Maximum power dissipation	18
5.6	Thermal shutdown considerations	19
5.7	Safe operating area	19
5.8	Capacitive load and stability	20
5.9	PCB layout recommendations	21
5.10	Decoupling capacitor	21
6	Typical applications	22
6.1	Rotary resolver	22
6.2	Design requirements	22
6.3	Increasing output current	23
7	Package information	24
7.1	SO8 exposed pad package information	25
7.2	DFN8 3x3 exposed pad, wettable flank package information	27
8	Ordering information	29
	Revision history	30

List of tables

Table 1.	Pin description (SO8/DFN8)	2
Table 2.	Absolute maximum ratings	3
Table 3.	Operating condition	3
Table 4.	Electrical characteristics for $V_{CC+} = 36\text{ V}$, $V_{CC-} = 0\text{ V}$, $V_{icm} = V_{out} = V_{cc}/2$, and $T_{amb} = 25\text{ °C}$ (unless otherwise specified)	4
Table 5.	Electrical characteristics for $V_{CC+} = 12\text{ V}$, $V_{CC-} = 0\text{ V}$, $V_{icm} = V_{out} = V_{cc}/2$, and $T_{amb} = 25\text{ °C}$ (unless otherwise specified)	6
Table 6.	Electrical characteristics for $V_{CC+} = 5\text{ V}$, $V_{CC-} = 0\text{ V}$, $V_{icm} = V_{out} = V_{cc}/2$, and $T_{amb} = 25\text{ °C}$ (unless otherwise specified)	8
Table 7.	SO8 exposed pad mechanical data	25
Table 8.	DFN8 3x3 exposed pad, wettable flank mechanical data	27
Table 9.	Order codes	29
Table 10.	Document revision history	30

List of figures

Figure 1.	Pin connections for each package (top view)	2
Figure 2.	Supply current vs. supply voltage (per channel)	10
Figure 3.	Supply current vs. input common mode voltage per channel ($V_{CC} = 36\text{ V}$)	10
Figure 4.	Input offset voltage distribution, $T = 25\text{ }^{\circ}\text{C}$, $V_{CC} = 12\text{ V}$	10
Figure 5.	Input offset voltage temperature coefficient distribution from $-40\text{ }^{\circ}\text{C}$ to $25\text{ }^{\circ}\text{C}$ ($\mu\text{V}/^{\circ}\text{C}$), $V_{CC} = 12\text{ V}$	10
Figure 6.	Input offset voltage temperature coefficient distribution from $25\text{ }^{\circ}\text{C}$ to $125\text{ }^{\circ}\text{C}$ ($\mu\text{V}/^{\circ}\text{C}$), $V_{CC} = 12\text{ V}$	11
Figure 7.	Input offset voltage vs. supply voltage	11
Figure 8.	Input offset voltage vs. input common mode voltage $V_{CC} = 36\text{ V}$	11
Figure 9.	Input bias current vs. temperature at mid V_{ICM}	11
Figure 10.	Output voltage drop vs. output current load, $V_{CC} = 36\text{ V}$, $V_{icm} = V_{CC}/2$, $V_{id} = -1\text{ V}$ for sink, $+1\text{ V}$ for source	12
Figure 11.	High-level output voltage (drop from V_{CC+}) vs. V_{CC} , $I_{load} = 160\text{ mA}$	12
Figure 12.	High-level output voltage, (drop from V_{CC+}) vs. temperature, $I_{load} = 160\text{ mA}$	12
Figure 13.	Low-level output voltage vs. V_{CC} , $I_{load} = 160\text{ mA}$	12
Figure 14.	Low-level output voltage vs. temperature, $I_{load} = 160\text{ mA}$	13
Figure 15.	Slew rate vs. V_{CC} , $R_{load} = 10\text{ k}\Omega$, $C_{load} = 100\text{ pF}$, comparator mode, $V_{diff} = 5\text{ V}$	13
Figure 16.	Small signal response at 36 V supply voltage	13
Figure 17.	Bode Diagram, $V_{CC} = 36\text{ V}$, $R_I = 10\text{ k}\Omega$, $C_{load} = 100\text{ pF}$, common mode voltage = 18 V	13
Figure 18.	Unity gain frequency vs. temperature, $V_{CC} = 36\text{ V}$, $R_I = 10\text{ k}\Omega$	14
Figure 19.	Phase margin vs. capacitive load $V_{CC} = 36\text{ V}$, $R_I = 10\text{ k}\Omega$	14
Figure 20.	Gain margin vs. capacitive load $V_{CC} = 36\text{ V}$, $R_I = 10\text{ k}\Omega$	14
Figure 21.	Overshoot vs. capacitive load	14
Figure 22.	Noise vs. frequency for different supply voltages	15
Figure 23.	THD vs. Output voltage swing for different frequencies, $V_{CC} = 36\text{ V}$, $R_I = 10\text{ k}\Omega$, $C_I = 100\text{ pF}$	15
Figure 24.	THD vs. frequency for different V_{cm} , $V_{CC} = 36\text{ V}$, $V_{icm} = V_{ocm} = V_{cm}$, $R_I = 10\text{ k}\Omega$, $C_I = 100\text{ pF}$	15
Figure 25.	PSRR vs. frequency	15
Figure 26.	Channel separation vs. frequency	16
Figure 27.	Equivalent internal ESD and input protection circuit	17
Figure 28.	EMI rejection ratio vs. frequency	18
Figure 29.	SO8 safe operating area, one channel active	19
Figure 30.	DFN8 safe operating area, one channel active	19
Figure 31.	Stability criteria with a serial resistor at different capacitive loads	20
Figure 32.	Test configuration for R_{ISO}	20
Figure 33.	Rotary resolver excitation amplifier	22
Figure 34.	Increasing output current	23
Figure 35.	SO8 exposed pad package outline	25
Figure 36.	SO8 exposed pad footprint data	26
Figure 37.	DFN8 3x3 exposed pad, wettable flank package outline and mechanical data	27
Figure 38.	DFN8 3x3 exposed pad, wettable flank footprint data	28

IMPORTANT NOTICE – READ CAREFULLY

STMicroelectronics NV and its subsidiaries (“ST”) reserve the right to make changes, corrections, enhancements, modifications, and improvements to ST products and/or to this document at any time without notice. Purchasers should obtain the latest relevant information on ST products before placing orders. ST products are sold pursuant to ST’s terms and conditions of sale in place at the time of order acknowledgment.

Purchasers are solely responsible for the choice, selection, and use of ST products and ST assumes no liability for application assistance or the design of purchasers’ products.

No license, express or implied, to any intellectual property right is granted by ST herein.

Resale of ST products with provisions different from the information set forth herein shall void any warranty granted by ST for such product.

ST and the ST logo are trademarks of ST. For additional information about ST trademarks, refer to www.st.com/trademarks. All other product or service names are the property of their respective owners.

Information in this document supersedes and replaces information previously supplied in any prior versions of this document.

© 2022 STMicroelectronics – All rights reserved