

170 V, 3 A power Schottky rectifier

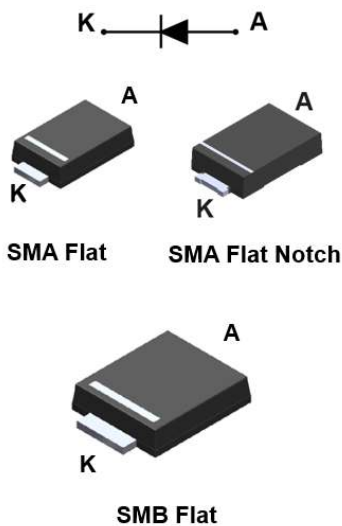

Features

- Negligible switching losses
- High junction temperature capability
- Very small conduction losses
- Low leakage current
- Avalanche rated
- ECOPACK2 component

Applications

- Switching diode
- SMPS
- DC / DC converter
- Telecom power

Description

The STPS3170 is a 170 V Schottky rectifier suited for switch mode power supplies and high frequency DC to DC converters.

Packaged in SMA Flat, SMA Flat Notch and SMB Flat, the **STPS3170** is ideal for use in low voltage, high frequency inverters, freewheeling and polarity protection. Also ideal for all LED lighting applications where efficiency and space constraint are required.

Product status	
STPS3170	
Product summary	
Symbol	Value
$I_{F(AV)}$	3 A
V_{RRM}	170 V
$T_{j(max.)}$	175 °C
$V_{F(typ.)}$	0.63 V

1 Characteristics

Table 1. Absolute ratings (limiting values at 25 °C, unless otherwise specified)

Symbol	Parameter	Value	Unit	
V _{RRM}	Repetitive peak reverse voltage	170	V	
V _{RRM}	Repetitive peak reverse voltage, T _j = -40 °C	160	V	
I _{F(RMS)}	Forward rms current	15	A	
I _{F(AV)}	Average forward current, δ = 0.5, square wave	SMA Flat, SMA Flat Notch T _L = 130 °C	3	A
		SMB Flat T _L = 140 °C		
I _{FSM}	Surge non repetitive forward current	SMA Flat, SMA Flat Notch	75	A
		SMB Flat		
P _{ARM}	Repetitive peak avalanche power	t _p = 10 μs, T _j = 125 °C	210	W
T _{stg}	Storage temperature range	-65 to +175	°C	
T _j	Maximum operating junction temperature ⁽¹⁾	+175	°C	

1. $(dP_{tot}/dT_j) < (1/R_{th(j-a)})$ condition to avoid thermal runaway for a diode on its own heatsink.

Table 2. Thermal resistance parameter

Symbol	Parameter	Max. value	Unit
R _{th(j-l)}	Junction to lead	SMA Flat, SMA Flat Notch	20
		SMB Flat	15

For more information, please refer to the following application note :

- AN5088 : Rectifiers thermal management, handling and mounting recommendations

Table 3. Static electrical characteristics

Symbol	Parameter	Test conditions	Min.	Typ.	Max.	Unit
I _R ⁽¹⁾	Reverse leakage current	T _j = 25 °C	V _R = V _{RRM}	-	4.0	μA
		T _j = 125 °C		-	0.73	4.0
V _F ⁽²⁾	Forward voltage drop	T _j = 25 °C	I _F = 3 A	-	0.82	V
		T _j = 125 °C		-	0.63	
		T _j = 25 °C	I _F = 6 A	-	0.89	
		T _j = 125 °C		-	0.70	

1. Pulse test: t_p = 5 ms, δ < 2%

2. Pulse test: t_p = 380 μs, δ < 2%

To evaluate the conduction losses, use the following equation: $P = 0.59 \times I_{F(AV)} + 0.027 \times I_{F(RMS)}^2$

For more information, please refer to the following application notes related to the power losses :

- AN604: Calculation of conduction losses in a power rectifier
- AN4021: Calculation of reverse losses on a power diode

1.1 Characteristics (curves)

Figure 1. Average forward power dissipation versus average forward current

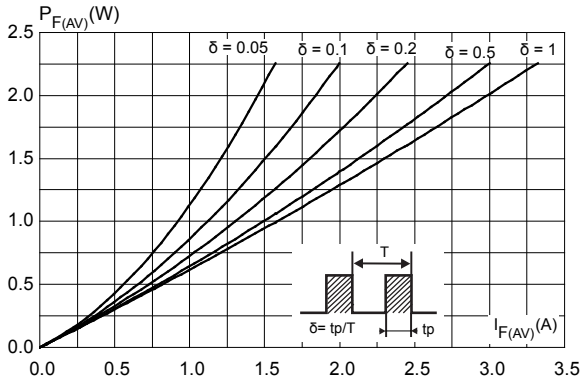

Figure 2. Average forward current versus ambient temperature ($\delta = 0.5$)

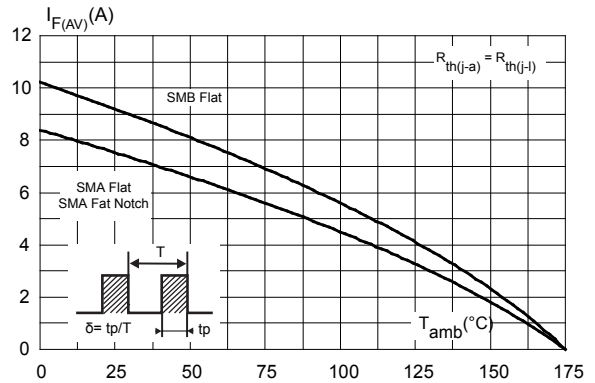

Figure 3. Relative variation of thermal impedance junction to lead versus pulse duration

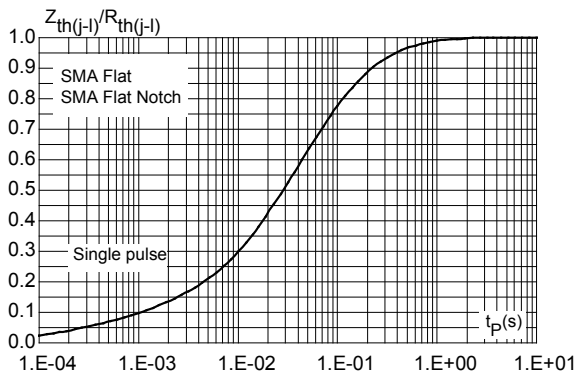

Figure 4. Relative variation of thermal impedance junction to lead versus pulse duration

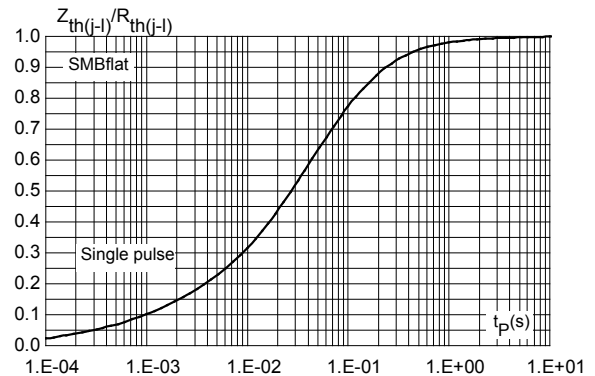

Figure 5. Reverse leakage current versus reverse voltage applied (typical values)

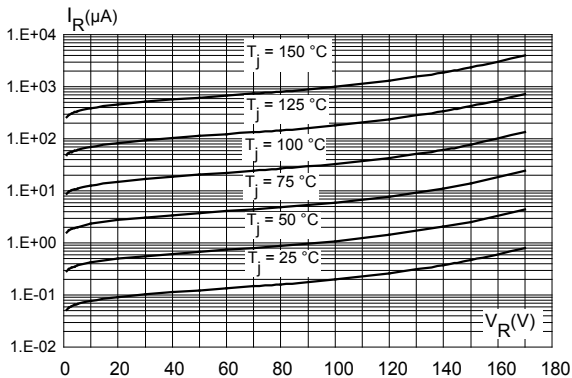

Figure 6. Junction capacitance versus reverse voltage applied (typical values)

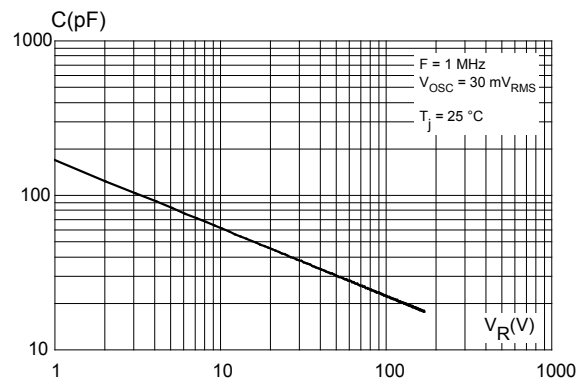

Figure 7. Forward voltage drop versus forward current (typical values)

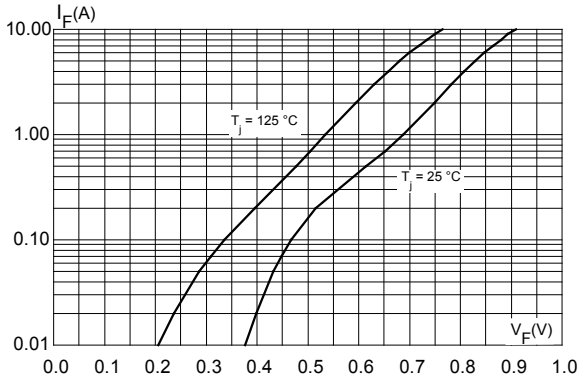

Figure 8. Forward voltage drop versus forward current (maximum values)

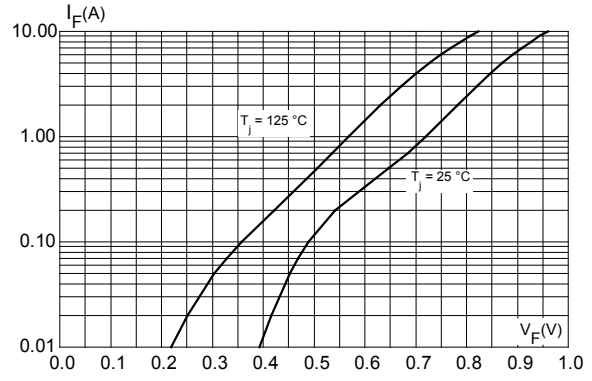

Figure 9. Thermal resistance junction to ambient versus copper surface under each lead (SMB Flat)

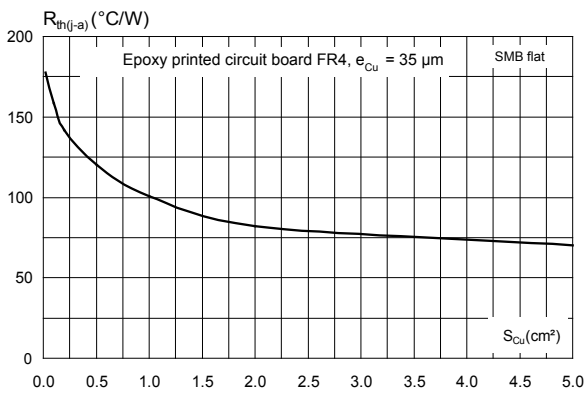

Figure 10. Thermal resistance junction to ambient versus copper surface under each lead (SMA Flat, SMA Flat Notch)

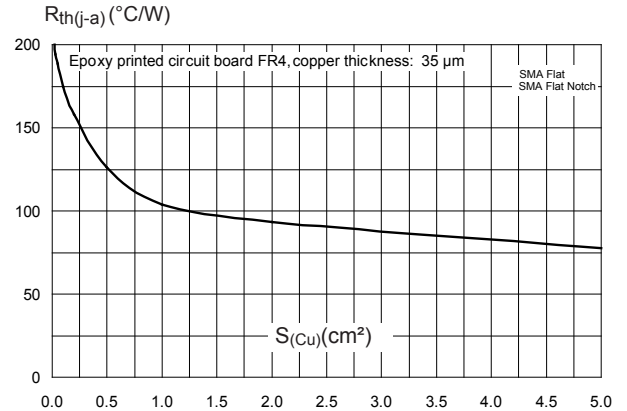
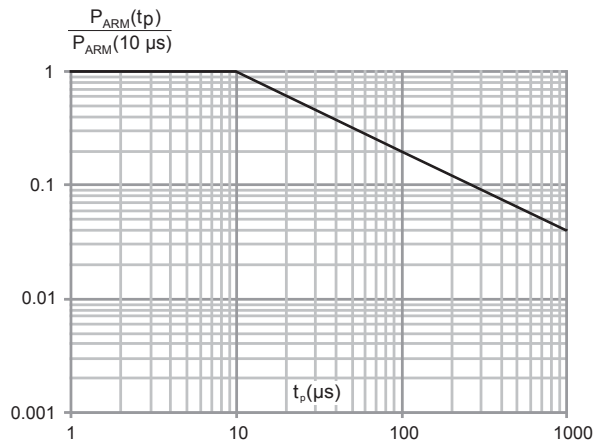

Figure 11. Normalized avalanche power derating versus pulse duration ($T_j = 125^\circ\text{C}$)



2 Package information

In order to meet environmental requirements, ST offers these devices in different grades of **ECOPACK** packages, depending on their level of environmental compliance. ECOPACK specifications, grade definitions and product status are available at: www.st.com. ECOPACK is an ST trademark.

2.1 SMB Flat package information

- Epoxy meets UL94, V0
- Lead-free package

Figure 12. SMB Flat package outline

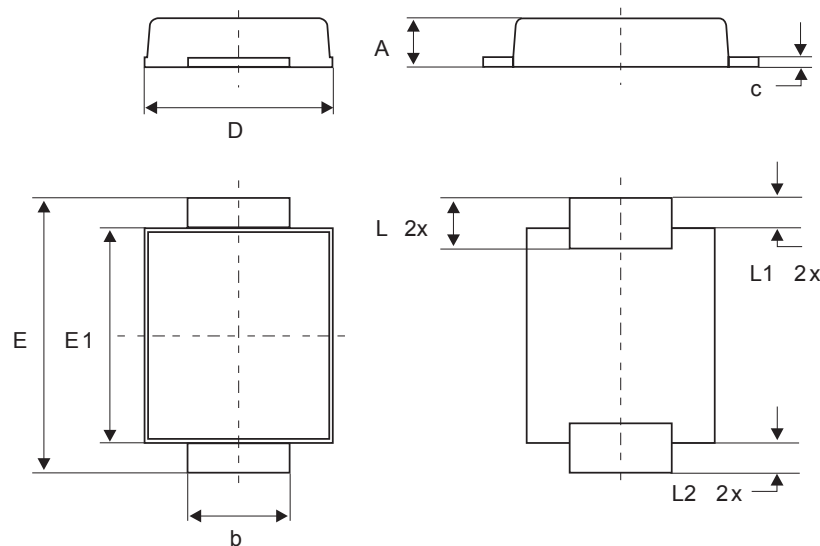
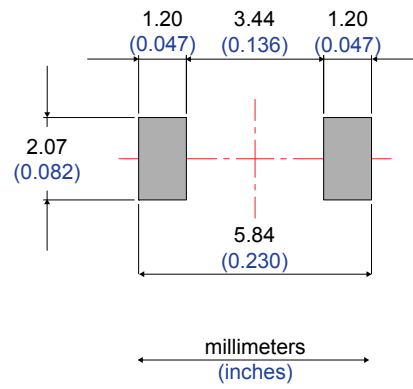

Table 4. SMB Flat mechanical data

Ref.	Dimensions					
	Millimeters			Inches		
	Min.	Typ.	Max.	Min.	Typ.	Max.
A	0.90		1.10	0.035		0.044
b	1.95		2.20	0.076		0.087
c	0.15		0.40	0.005		0.016
D	3.30		3.95	0.129		0.156
E	5.10		5.60	0.200		0.221
E1	4.05		4.60	0.159		0.182
L	0.75		1.50	0.029		0.060
L1		0.40			0.016	
L2		0.60			0.024	

Figure 13. Footprint recommendations, dimensions in mm (inches)



2.2 SMA Flat package information

- Epoxy meets UL94, V0
- Lead-free package

Figure 14. SMA Flat package outline

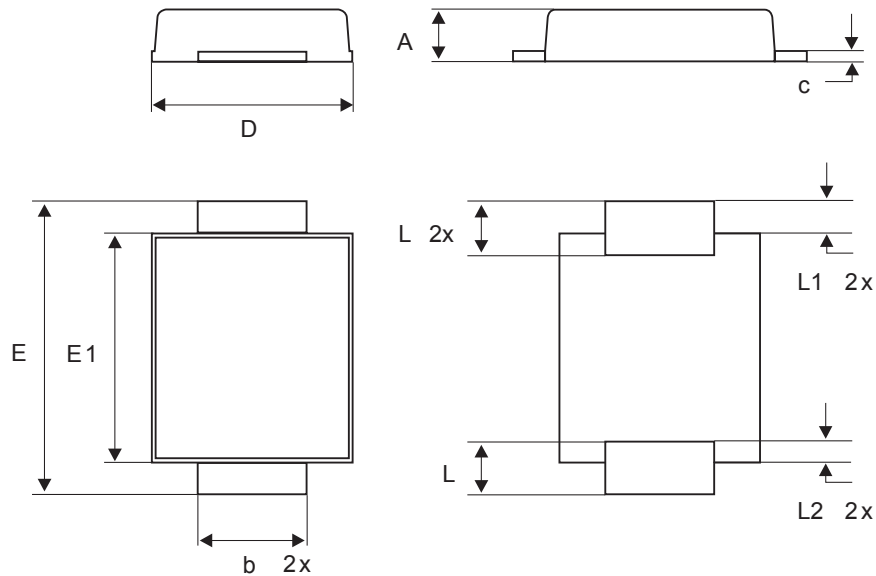
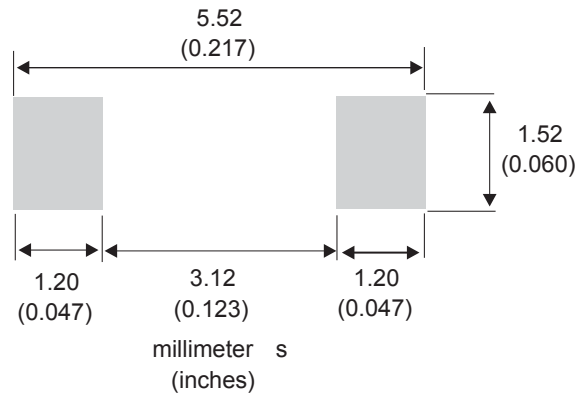

Table 5. SMA Flat package mechanical data

Ref.	Dimensions					
	Millimeters			Inches (for reference only)		
	Min.	Typ.	Max.	Min.	Typ.	Max.
A	0.90		1.10	0.035		0.044
b	1.25		1.65	0.049		0.065
c	0.15		0.40	0.005		0.016
D	2.25		2.95	0.088		0.117
E	4.80		5.60	0.188		0.221
E1	3.95		4.60	0.155		0.182
L	0.75		1.50	0.029		0.060
L1		0.50			0.020	
L2		0.50			0.020	

Figure 15. SMA Flat recommended footprint in mm (inches)



2.3 SMA Flat Notch package information

- Epoxy meets UL94, V0
- Cooling method: by conduction (C)
- Band indicates cathode

Figure 16. SMA Flat Notch package outline

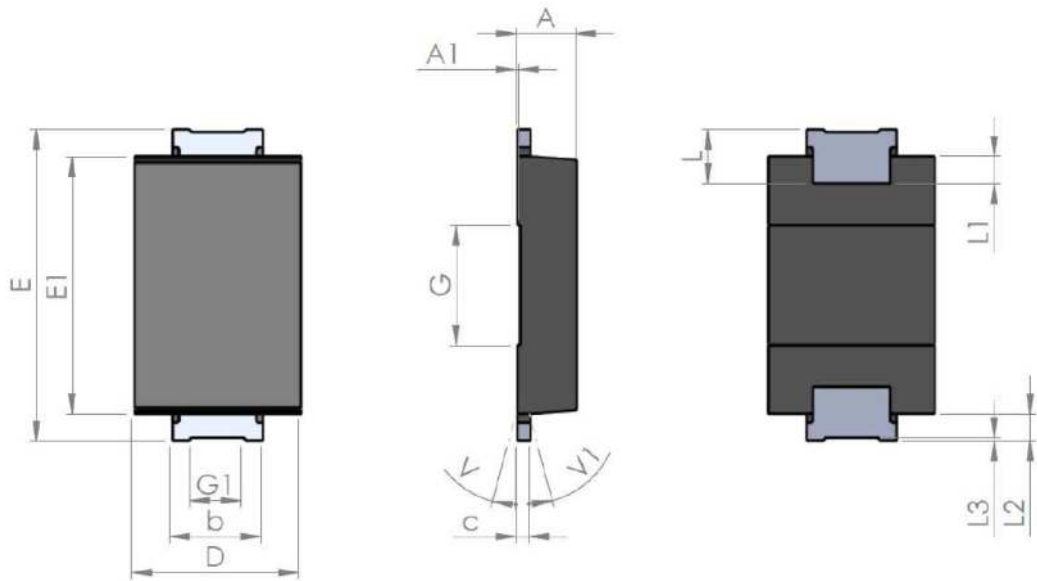
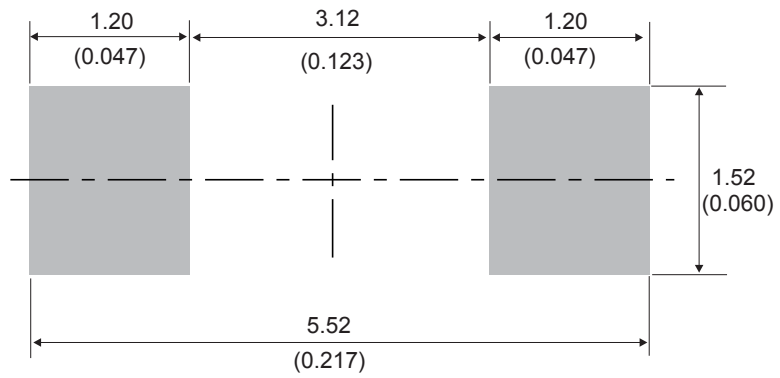

Table 6. SMA Flat Notch package mechanical data

Ref.	Dimensions					
	Millimeters			Inches (for reference only)		
	Min.	Typ.	Max.	Min.	Typ.	Max.
A1	0.90		1.10	0.035		0.044
A1		0.05			0.002	
b	1.25		1.65	0.049		0.065
C	0.15		0.40	0.005		0.016
D	2.25		2.90	0.088		0.115
E	5.00		5.35	0.196		0.211
E1	3.95		4.60	0.155		0.182
G		2.00			0.079	
G1		0.85			0.033	
L	0.75		1.20	0.029		
L1		0.45			0.018	
L2		0.45			0.018	
L3		0.05			0.002	
V			8°			8°
V1			8°			8°

Figure 17. SMA Flat Notch recommended footprint in mm (inches)



3 Ordering information

Table 7. Ordering information

Order code	Marking	Package	Weight	Base qty.	Delivery mode
STPS3170AF	F317	SMA Flat	0.035 g	10 000	Tape and reel
STPS3170AFN	A3170	SMA Flat Notch	0.039 g	10 000	Tape and reel
STPS3170UF	FG317	SMB Flat	0.050 g	5000	Tape and reel

Revision history

Table 8. Document revision history

Date	Version	Changes
17-Oct-2014	1	First release.
08-Oct-2019	2	Added Section 2.3 SMA Flat Notch package information .

IMPORTANT NOTICE – PLEASE READ CAREFULLY

STMicroelectronics NV and its subsidiaries (“ST”) reserve the right to make changes, corrections, enhancements, modifications, and improvements to ST products and/or to this document at any time without notice. Purchasers should obtain the latest relevant information on ST products before placing orders. ST products are sold pursuant to ST’s terms and conditions of sale in place at the time of order acknowledgement.

Purchasers are solely responsible for the choice, selection, and use of ST products and ST assumes no liability for application assistance or the design of Purchasers’ products.

No license, express or implied, to any intellectual property right is granted by ST herein.

Resale of ST products with provisions different from the information set forth herein shall void any warranty granted by ST for such product.

ST and the ST logo are trademarks of ST. For additional information about ST trademarks, please refer to www.st.com/trademarks. All other product or service names are the property of their respective owners.

Information in this document supersedes and replaces information previously supplied in any prior versions of this document.

© 2019 STMicroelectronics – All rights reserved