

Using the TPS51103EVM Integrated 3.3-V/5-V Power LDO with Clock Output

This document includes information regarding absolute operating conditions, power-supply requirements, and hardware configuration for the evaluation module. The electrical schematics and bill of materials are also included for reference purposes. Throughout this document, the phrase *evaluation module* and the abbreviation *EVM* are both synonymous with the TPS51103EVM.

Contents

1	Introduction	2
2	TPS51103EVM Electrical Performance Specifications	3
3	Schematic.....	4
4	Test Setup	5
5	Typical Characteristics	9
6	EVM Assembly Drawings and Layout	13
7	Bill of Materials	14

List of Figures

1	TPS51103EVM Power Stage/Control Schematic.....	4
2	TPS51103EVM Recommended Test Setup.....	6
3	5-V and 3.3-V Enable Configuration	7
4	Switchover Function Enabled	7
5	VREG5 Load Regulation.....	9
6	VREG3 Load Regulation.....	9
7	15V_OUT Load Regulation.....	9
8	VRTC3 Load Regulation	9
9	0-mA to 100-mA Load Step on 5-V Output	10
10	0-mA to 100-mA Load Step on 3.3-V Output	10
11	5.0-V Switch Over	11
12	5.0-V Switch Over	11
13	3.3-V Switch Over	11
14	3.3-V Switch Over	11
15	Clock Startup.....	12
16	Clock Steady.....	12
17	TPS51103EVM Component Placement (Top View)	13
18	TPS51103EVM Top Copper (Top View)	13
19	TPS51103EVM Bottom Copper (X-Ray View from Top).....	14

List of Tables

1	Electrical Performance Specifications.....	3
2	Meters	5
3	Test Points.....	8
8	TPS51103EVM Bill of Materials	14

All trademarks are the property of their respective owners.

1 Introduction

The TPS51103EVM evaluation module (EVM) is an integrated power LDO solution platform for testing and evaluation of the TPS51103, an integrated LDO with switch-over circuit for notebook computers (TI Literature Number [SLUS808](#)) The EVM delivers 3.3-V and 5-V of output voltage at 100 mA. It also produces an *always-on* 3.3-V low-dropout (LDO) output at 5 mA.

1.1 Description

The EVM generates 3.3-V and 5-V LDO output from a wide input range of 5.5 V to 28 V. The rated current for each output is 100 mA. The EVM also delivers an *always-on* 3.3-V, 5 m-A output. The glitch-free switchover function offers better system efficiency under light load conditions. When the switchover function is enabled, the LDO load is supplied by an external input source that eliminates the power loss generated as a result of the voltage drop across the LDO. A 250-kHz clock is generated for the charge pump feature. The clock is enabled when 5VIN is greater than 2 V. On the EVM, 15V_OUT is generated by a charge pump and is only available when 5VIN is applied and the 250-kHz clock is generated.

1.2 Applications

- Computing power, including notebooks and servers
- Networking equipment
- Telecommunications equipment
- Distributed dc power systems
- Broad market

1.3 Features

- 5.5-V to 28-V wide input range
- 3.3-V/5-V, 100-mA LDO output with enable
- *Always-on* 3.3-V LDO output at 5 mA
- 250-kHz clock output for charge pump
- Glitch-free switchover circuit

2 TPS51103EVM Electrical Performance Specifications

Table 1. Electrical Performance Specifications

PARAMETER		CONDITIONS	MIN	TYP	MAX	UNITS
INPUT CHARACTERISTICS						
V_{IN}	Input voltage range		5.5		28	V
OUTPUT1 (5V_OUT)						
	Output voltage			5		V
	Load regulation	$0\text{ A} < I_{OUT1} < 100\text{ mA}$, $V_{IN} = 12\text{ V}$			5%	
	Output load current	I_{OUT1}	0		100	mA
	Output overcurrent			160		
OUTPUT1 (3.3V_OUT)						
	Output voltage			3.3		V
	Load regulation	$0\text{ A} < I_{OUT2} < 100\text{ mA}$, $V_{IN} = 12\text{ V}$			5%	
	Output load current		0		100	mA
	Output overcurrent			150		
OUTPUT1 (3.3V_RTC)						
	Output voltage			3.3		V
	Load regulation	$0\text{ A} < I_{OUT3} < 5\text{ mA}$, $V_{IN} = 12\text{ V}$			5%	
	Output load current	I_{OUT3}	0		5	mA
OUTPUT1 (15V_OUT)						
	Output voltage			12		V
	Output load current		0		10	mA

3 Schematic

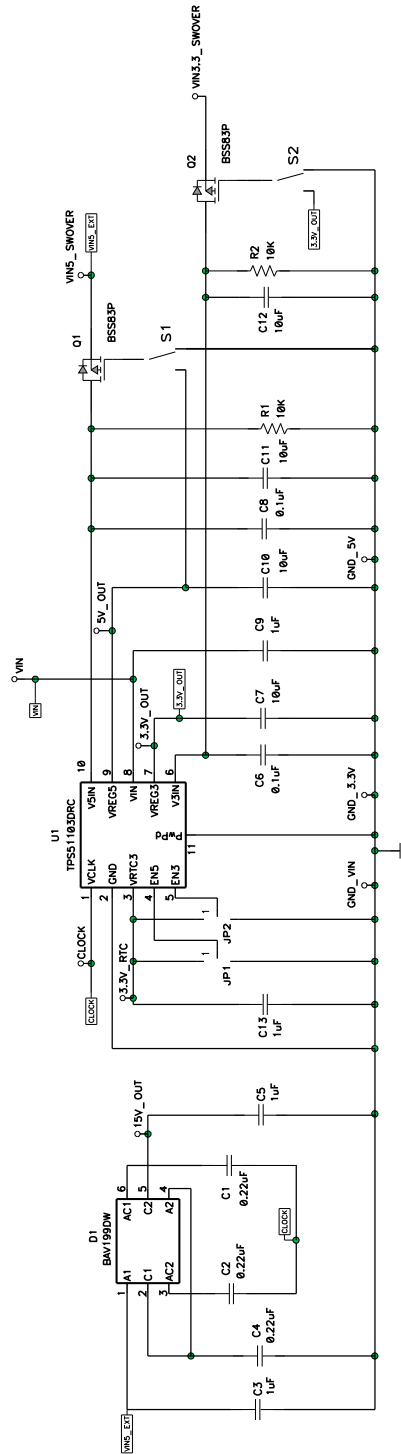

Figure 1. TPS51103EVM Power Stage/Control Schematic

Note: For reference only; see the enclosed [Bill of Materials](#) for specific values.

4 Test Setup

4.1 Recommended Test Equipment

4.1.1 Voltage Source

4.1.1.1 V_{IN}

The input voltage source, V_{IN} , should be a variable dc source, capable of 1-A dc, between 0 V and 30 V. Connect V_{IN} as shown in [Figure 2](#).

4.1.1.2 V_{IN5}

This voltage source is applied only when the switchover function is tested. The voltage source should be a variable dc source, capable of 1-A dc, between 0 V and 6 V .

4.1.1.3 $V_{IN3.3}$

This voltage source is applied only when the switchover function is tested. The voltage source should be a variable dc source, capable of 1-A dc, between 0 V and 6 V .

4.1.2 Meters

Table 2. Meters

NODE	SOURCE	VOLTMETER RANGE (V)
V1	VIN	0-30
V2	VIN5	0-6
V3	VIN3.3	
V4	5V_OUT	
V5	3.3V_OUT	
V6	3.3V_RTC	
V7	15V_OUT	0-20

4.1.3 Loads

Either electronic load resistors or adjustable resistors can be used.

4.2 Equipment Setup

4.2.1 Electrostatic Discharge Warning

CAUTION

Failure to observe proper ESD handling procedures may result in damage to the EVM components.

Many of the components used in the assembly of the TPS51103EVM are susceptible to damage by electrostatic discharge (ESD). Customers are advised to observe proper ESD handling procedures when unpacking and handling the TPS51103EVM. All handling should be performed at an approved ESD workstation or test bench, using a grounded wrist strap. Failure to observe proper handling procedures may result in damage to EVM components. An electrostatic smock and safety glasses should also be worn.

4.2.2 Input Connections

Figure 2 shows the recommended test setup to evaluate the TPS51103EVM.

Before connecting the dc input sources, make sure that all sources are initially set to 0 V and connected as shown in Figure 2.

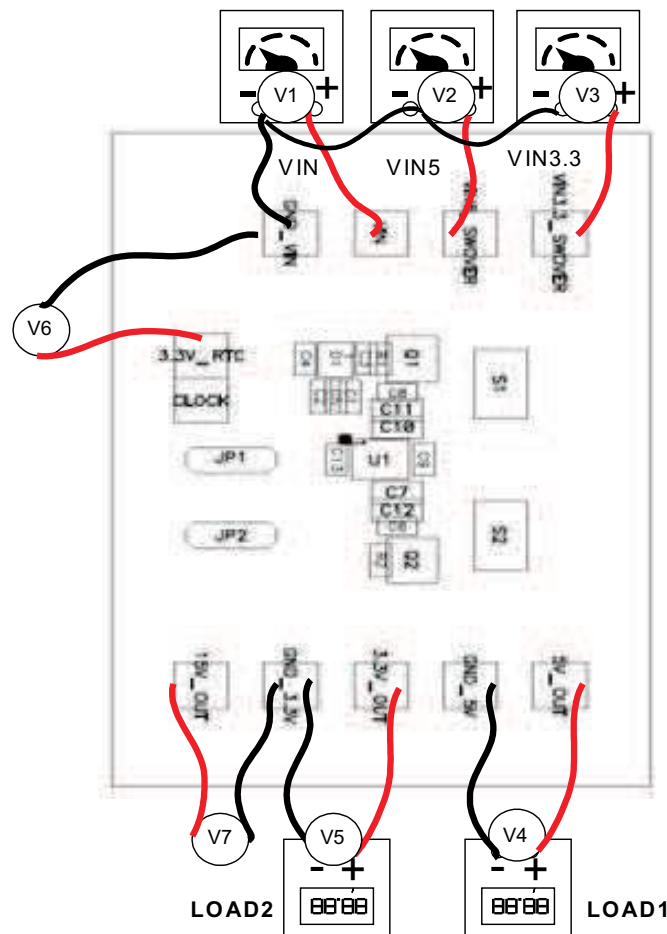

Figure 2. TPS51103EVM Recommended Test Setup

4.2.3 Output Connections

Configure the output connections in the following order.

- Step 1. Connect LOAD1 and LOAD2 to 5V_OUT and 3.3V_OUT, respectively. Set LOAD1 and LOAD2 to sink 0 A dc before V_{IN} is applied.
- Step 2. Connect voltmeters V4-V7 as shown in [Figure 2](#).

4.3 Startup and Test Procedure

1. Ensure that LOAD1 and LOAD2 are set to constant current mode and to sink 0 A dc.
2. Increase V_{IN} (V1) from 0 V to 10 V dc. 5V_OUT (V4), 3.3V_OUT (V5), and 3.3V_RTC (V6) should correspond to the specifications shown in [Table 1](#).
3. Vary the LOAD of 5V_OUT and 3.3V_OUT from 0 mA dc to 100 mA dc. 5V_OUT and 3.3V_OUT should remain within the specifications given [Table 1](#) for all load combinations on LOAD up to 100 mA.
4. Vary V_{IN} from 5.5 V dc to 28 V dc. 5V_OUT (V4), 3.3V_OUT (V5), and 3.3V_RTC (V6) should correspond to the specifications shown in [Table 1](#).
5. Keep V_{IN} at 12 V. Increase VIN5 (V2) to 5.5 V; then toggle switch S1 as shown in [the following EVM configuration](#) to enable a 5-V switchover function. Measure 5V_OUT (V4) at a no load condition; V4 should be very close to V2. Measure 15V_OUT (V7) at a no load state; it should be within the limits given in [Table 1](#).
6. Keep V_{IN} at 12 V. Increase VIN3.3 (V3) to 3.5 V, and toggle switch S2 as shown in [the following EVM configuration](#) to enable a 3.3-V switchover function. Measure 3.3V_OUT (V5) at a no load condition; V5 should be very close to V3.

4.4 Evaluation Module Configuration

By default, the switchover function is disabled. To enable the switchover function, simply toggle switches S1 and S2 for a 5-V and 3.3-V switchover, respectively. The position of the switch is opposite of the pins shorted.

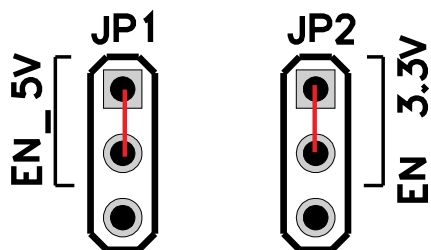

Figure 3. 5-V and 3.3-V Enable Configuration

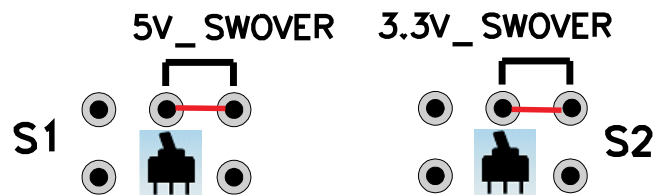

Figure 4. Switchover Function Enabled

4.5 Test Points

Several test points are located around the board. [Table 3](#) lists these various test points and the respective uses of each.

Table 3. Test Points

TEST POINT LABEL	DESCRIPTION
VIN	Input voltage positive sense point
GND_VIN	Input voltage negative sense point
VIN5	5-V input voltage for switch over
VIN3.3	3.3-V input voltage for switch over
5V_OUT	5-V LDO output positive sense point
GND_5V	5-V LDO output negative sense point
3.3V_OUT	3.3-V LDO output positive sense point
GND_3.3V	3.3-V LDO output negative sense point
15V_OUT	Charge pump output positive sense point
3.3V_RTC	3.3-V LDO output for real time clock
CLOCK	250-kHz clock for charge pump

4.6 Equipment Shutdown

Follow these procedures to properly shut down the EVM.

- Step 1. Shut down LOAD.
- Step 2. Shut down all input voltage sources.
- Step 3. Restore the default positions of all switches.

5 Typical Characteristics

5.1 Load Regulation

Figure 5 through Figure 16 present typical performance graphs for the TPS51103EVM. Because actual performance data can be affected by measurement techniques and environmental variables, these curves are presented for reference only and may differ from actual field measurements.

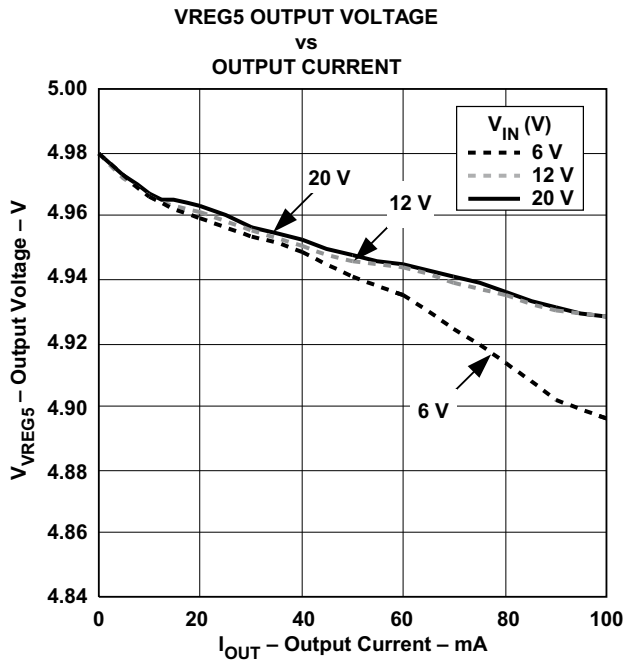

Figure 5. VREG5 Load Regulation

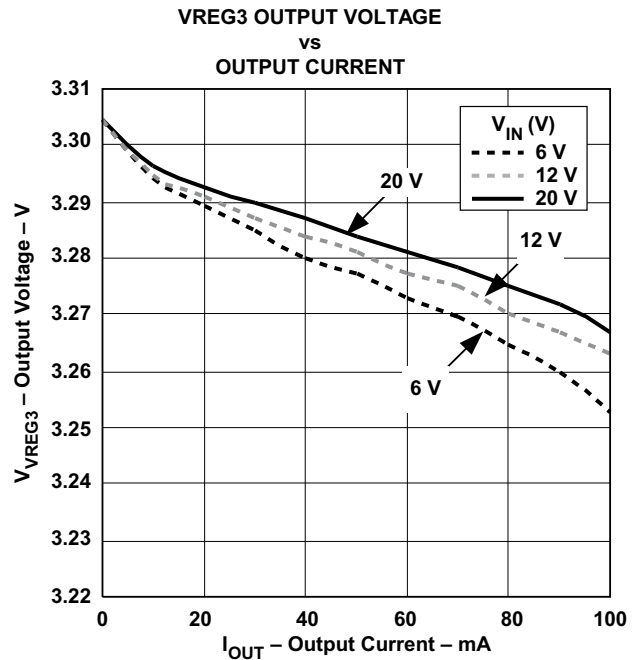

Figure 6. VREG3 Load Regulation

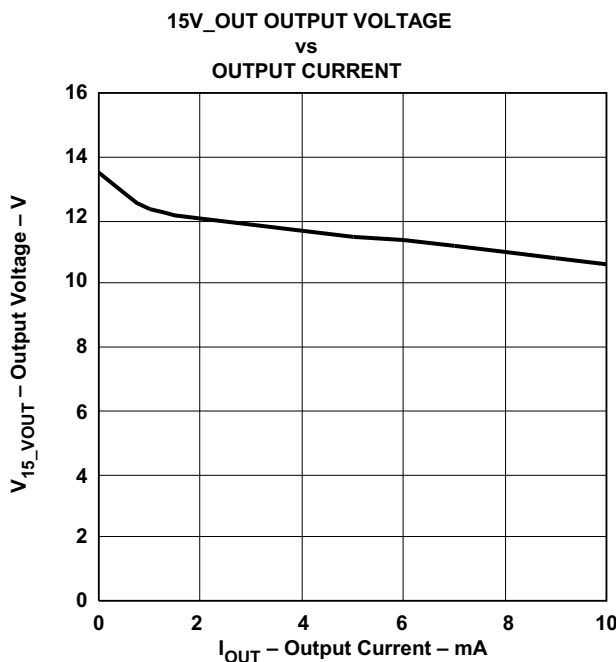

Figure 7. 15V_OUT Load Regulation

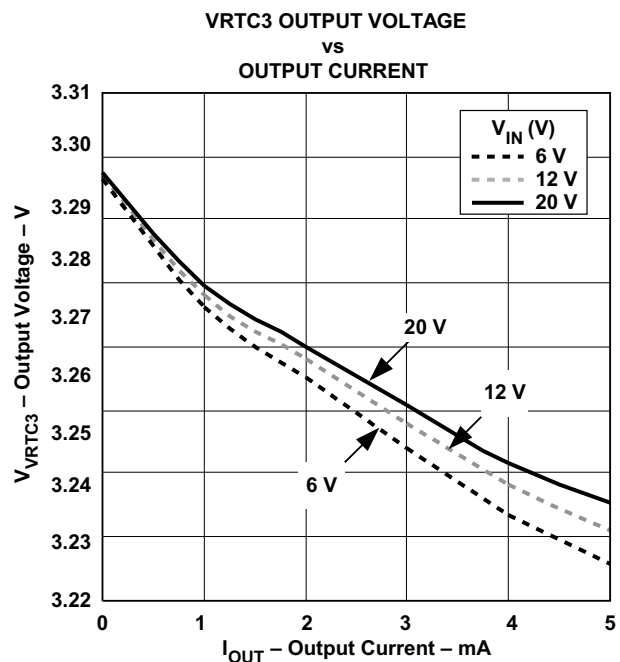

Figure 8. VRTC3 Load Regulation

5.2 Transient Response

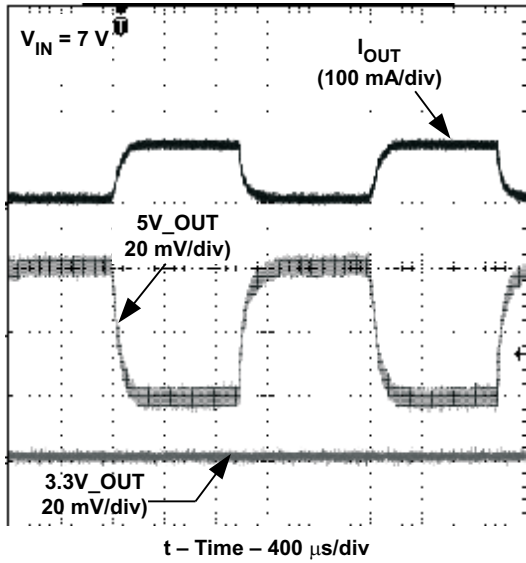

Figure 9. 0-mA to 100-mA Load Step on 5-V Output

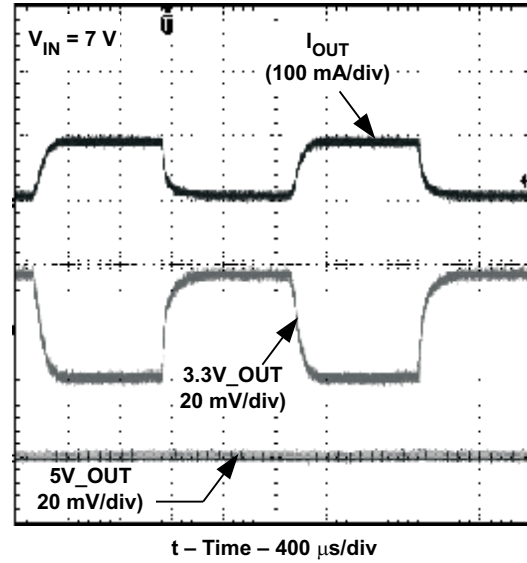

Figure 10. 0-mA to 100-mA Load Step on 3.3-V Output

5.3 Switchover Function

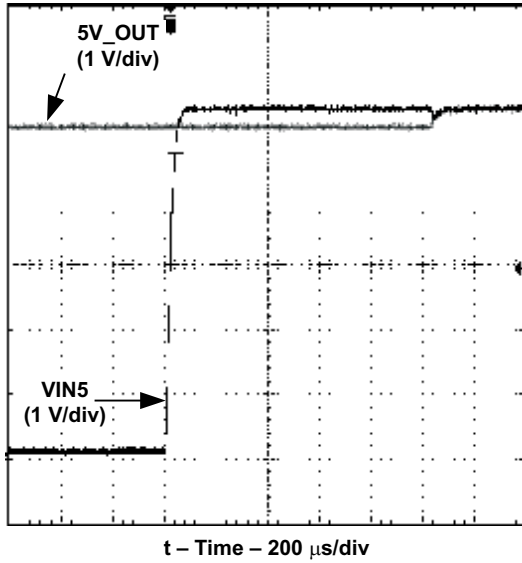

Figure 11. 5.0-V Switchover

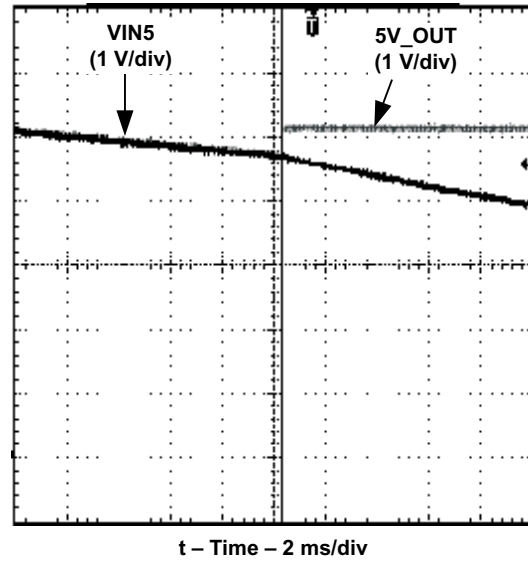

Figure 12. 5.0-V Switchover

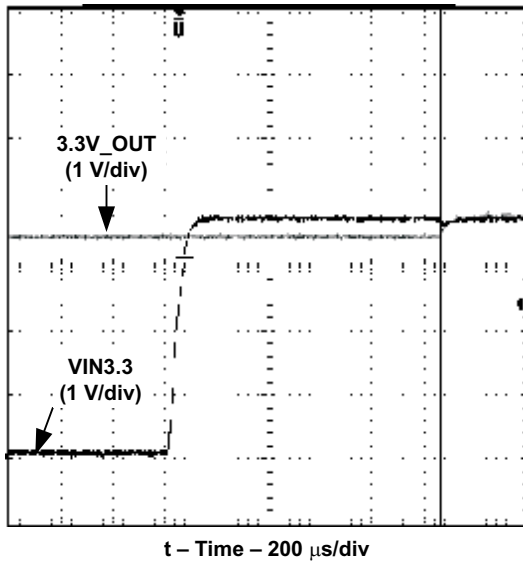

Figure 13. 3.3-V Switchover

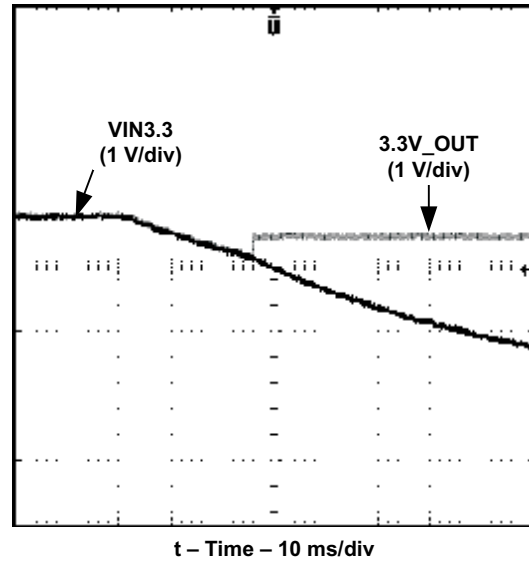

Figure 14. 3.3-V Switchover

5.4 Clock and 15V_OUT

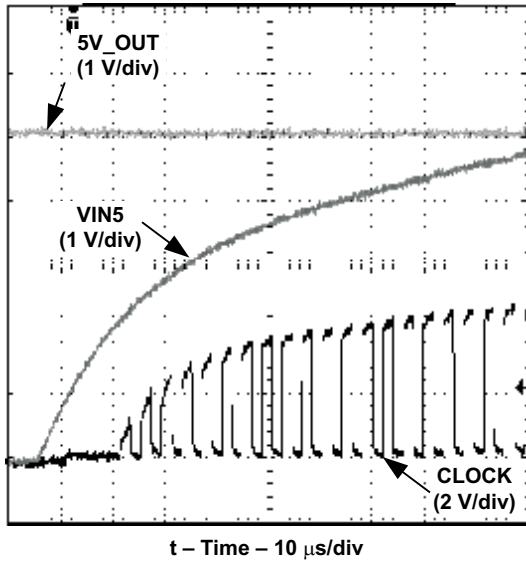

Figure 15. Clock Startup

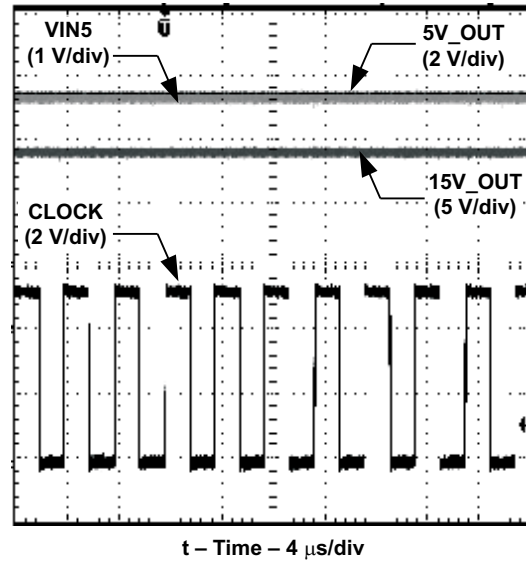

Figure 16. Clock Steady

6 EVM Assembly Drawings and Layout

Figure 17 through Figure 19 show the design of the TPS51103EVM printed circuit board (PCB). This EVM was designed using a two-layer, 2-oz. copper-clad PCB with all components on the top side to allow the user to easily view, probe, and evaluate the TPS51103 control IC in a practical application. Moving components to both sides of the PCB or using additional internal layers can offer additional size reduction for space constrained systems.

Note: Board layouts are not to scale. These drawings are intended to show how the board is laid out; they are not intended to be used for manufacturing TPS51103EVM PCBs.

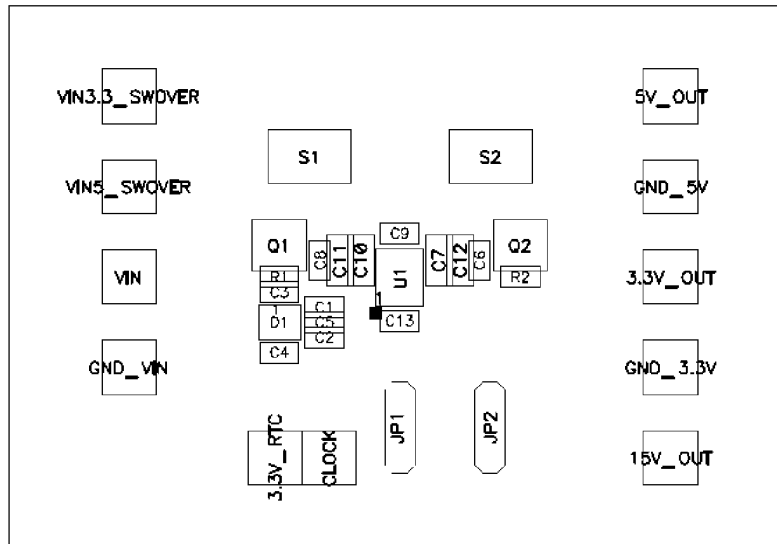

Figure 17. TPS51103EVM Component Placement (Top View)

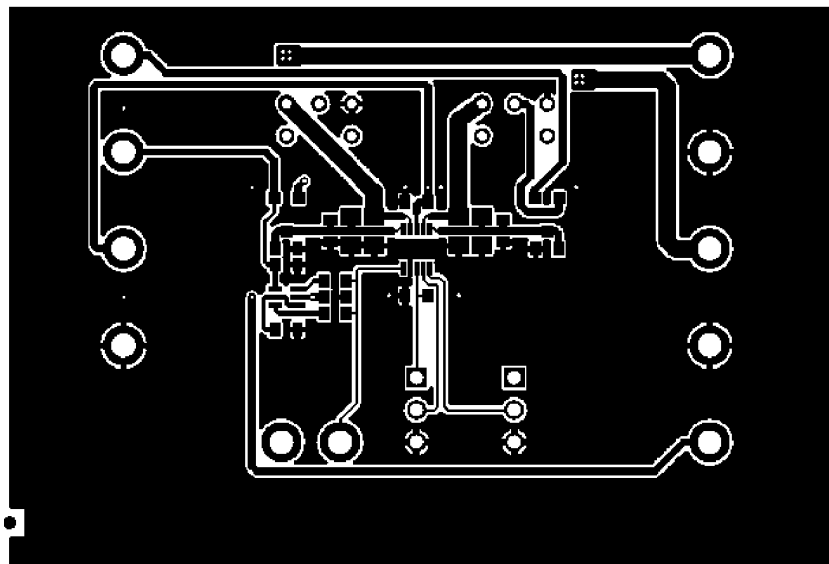

Figure 18. TPS51103EVM Top Copper (Top View)

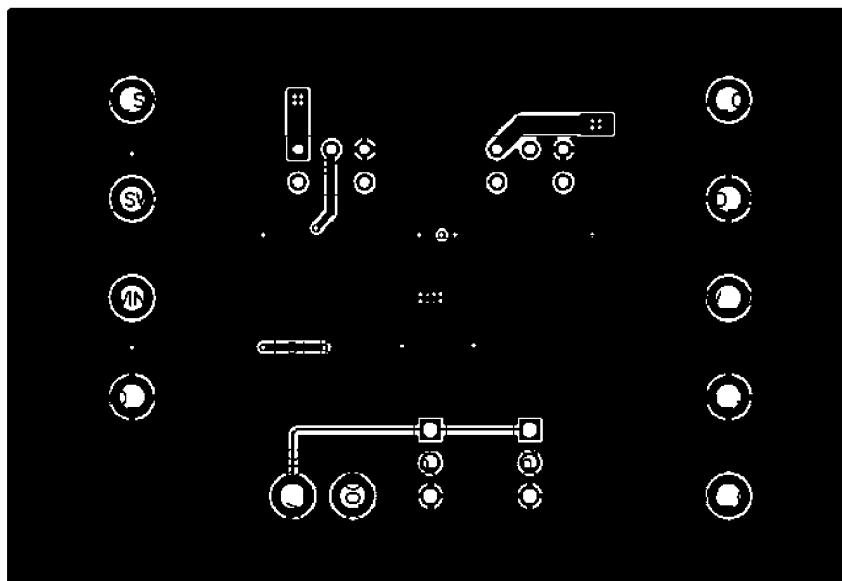

Figure 19. TPS51103EVM Bottom Copper (X-Ray View from Top)

7 Bill of Materials

Table 8. TPS51103EVM Bill of Materials

REFDES	VALUE	DESCRIPTION	SIZE	PART NUMBER	MFR
R1, R2	10 kΩ	Resistor, Chip, 1/16w, 1%	603	std	std
	3138-2	Pin, Wiring Terminal	0.09(D) X 0.31 inch	3138-2-00-15-00-00-080	Mill Max
C1, C2, C4	0.22 μF	Capacitor, Ceramic, 50 V, X7R, ±10%	0603	std	std
C3, C5, C9, C13	1 μF	Capacitor, Ceramic, 25 V, X5R, ±10%	0603	std	std
C6, C8	0.1 μF	Capacitor, Ceramic, 50 V, X7R, ±10%	0603	std	std
C7, C10, C11, C12	10 μF	Capacitor, Ceramic, 10 V, X5R, ±20%	0805	std	std
D1	BAV199DW	Diode, Quad Low Leakage, 160-mA, 85-V	SOT363	BAV199DW	Diodes
JP1, JP2		Header, 3-pin, 100-mil spacing, (36-pin strip)	0.100 x 3 inch	PTC36SAAN	Sullins
Q1, Q2		MOSFET, P-channel, -60 V, -0.33 A, 2 Ω	SOT23	BSS83P	Infineon
		MOSFET, P-channel, -12 V, -0.75 A, 0.18 Ω	SOT23	BSH205	NXP
S1, S2	G12AP	Switch, ON-ON Mini Toggle	0.28 x 0.18 inch	G12AP	NKK
U1		IC, Integrated Power LDO	DGS10	TPS51103DRC	TI
	2-382811-1	Jumper, 0.1-in, 2 contacts		2-382811-1	Tyco/AMP

EVALUATION BOARD/KIT IMPORTANT NOTICE

Texas Instruments (TI) provides the enclosed product(s) under the following conditions:

This evaluation board/kit is intended for use for **ENGINEERING DEVELOPMENT, DEMONSTRATION, OR EVALUATION PURPOSES ONLY** and is not considered by TI to be a finished end-product fit for general consumer use. Persons handling the product(s) must have electronics training and observe good engineering practice standards. As such, the goods being provided are not intended to be complete in terms of required design-, marketing-, and/or manufacturing-related protective considerations, including product safety and environmental measures typically found in end products that incorporate such semiconductor components or circuit boards. This evaluation board/kit does not fall within the scope of the European Union directives regarding electromagnetic compatibility, restricted substances (RoHS), recycling (WEEE), FCC, CE or UL, and therefore may not meet the technical requirements of these directives or other related directives.

Should this evaluation board/kit not meet the specifications indicated in the User's Guide, the board/kit may be returned within 30 days from the date of delivery for a full refund. **THE FOREGOING WARRANTY IS THE EXCLUSIVE WARRANTY MADE BY SELLER TO BUYER AND IS IN LIEU OF ALL OTHER WARRANTIES, EXPRESSED, IMPLIED, OR STATUTORY, INCLUDING ANY WARRANTY OF MERCHANTABILITY OR FITNESS FOR ANY PARTICULAR PURPOSE.**

The user assumes all responsibility and liability for proper and safe handling of the goods. Further, the user indemnifies TI from all claims arising from the handling or use of the goods. Due to the open construction of the product, it is the user's responsibility to take any and all appropriate precautions with regard to electrostatic discharge.

EXCEPT TO THE EXTENT OF THE INDEMNITY SET FORTH ABOVE, NEITHER PARTY SHALL BE LIABLE TO THE OTHER FOR ANY INDIRECT, SPECIAL, INCIDENTAL, OR CONSEQUENTIAL DAMAGES.

TI currently deals with a variety of customers for products, and therefore our arrangement with the user **is not exclusive**.

TI assumes **no liability for applications assistance, customer product design, software performance, or infringement of patents or services described herein.**

Please read the User's Guide and, specifically, the Warnings and Restrictions notice in the User's Guide prior to handling the product. This notice contains important safety information about temperatures and voltages. For additional information on TI's environmental and/or safety programs, please contact the TI application engineer or visit www.ti.com/esh.

No license is granted under any patent right or other intellectual property right of TI covering or relating to any machine, process, or combination in which such TI products or services might be or are used.

FCC Warning

This evaluation board/kit is intended for use for **ENGINEERING DEVELOPMENT, DEMONSTRATION, OR EVALUATION PURPOSES ONLY** and is not considered by TI to be a finished end-product fit for general consumer use. It generates, uses, and can radiate radio frequency energy and has not been tested for compliance with the limits of computing devices pursuant to part 15 of FCC rules, which are designed to provide reasonable protection against radio frequency interference. Operation of this equipment in other environments may cause interference with radio communications, in which case the user at his own expense will be required to take whatever measures may be required to correct this interference.

EVM WARNINGS AND RESTRICTIONS

It is important to operate this EVM within the input voltage range of xxx V to xxx V and the output voltage range of xxx V to xxx V.

Exceeding the specified input range may cause unexpected operation and/or irreversible damage to the EVM. If there are questions concerning the input range, please contact a TI field representative prior to connecting the input power.

Applying loads outside of the specified output range may result in unintended operation and/or possible permanent damage to the EVM. Please consult the EVM User's Guide prior to connecting any load to the EVM output. If there is uncertainty as to the load specification, please contact a TI field representative.

During normal operation, some circuit components may have case temperatures greater than xxx C. The EVM is designed to operate properly with certain components above xxx C as long as the input and output ranges are maintained. These components include but are not limited to linear regulators, switching transistors, pass transistors, and current sense resistors. These types of devices can be identified using the EVM schematic located in the EVM User's Guide. When placing measurement probes near these devices during operation, please be aware that these devices may be very warm to the touch.

Mailing Address: Texas Instruments, Post Office Box 655303, Dallas, Texas 75265
Copyright © 2008, Texas Instruments Incorporated

IMPORTANT NOTICE

Texas Instruments Incorporated and its subsidiaries (TI) reserve the right to make corrections, modifications, enhancements, improvements, and other changes to its products and services at any time and to discontinue any product or service without notice. Customers should obtain the latest relevant information before placing orders and should verify that such information is current and complete. All products are sold subject to TI's terms and conditions of sale supplied at the time of order acknowledgment.

TI warrants performance of its hardware products to the specifications applicable at the time of sale in accordance with TI's standard warranty. Testing and other quality control techniques are used to the extent TI deems necessary to support this warranty. Except where mandated by government requirements, testing of all parameters of each product is not necessarily performed.

TI assumes no liability for applications assistance or customer product design. Customers are responsible for their products and applications using TI components. To minimize the risks associated with customer products and applications, customers should provide adequate design and operating safeguards.

TI does not warrant or represent that any license, either express or implied, is granted under any TI patent right, copyright, mask work right, or other TI intellectual property right relating to any combination, machine, or process in which TI products or services are used. Information published by TI regarding third-party products or services does not constitute a license from TI to use such products or services or a warranty or endorsement thereof. Use of such information may require a license from a third party under the patents or other intellectual property of the third party, or a license from TI under the patents or other intellectual property of TI.

Reproduction of TI information in TI data books or data sheets is permissible only if reproduction is without alteration and is accompanied by all associated warranties, conditions, limitations, and notices. Reproduction of this information with alteration is an unfair and deceptive business practice. TI is not responsible or liable for such altered documentation. Information of third parties may be subject to additional restrictions.

Resale of TI products or services with statements different from or beyond the parameters stated by TI for that product or service voids all express and any implied warranties for the associated TI product or service and is an unfair and deceptive business practice. TI is not responsible or liable for any such statements.

TI products are not authorized for use in safety-critical applications (such as life support) where a failure of the TI product would reasonably be expected to cause severe personal injury or death, unless officers of the parties have executed an agreement specifically governing such use. Buyers represent that they have all necessary expertise in the safety and regulatory ramifications of their applications, and acknowledge and agree that they are solely responsible for all legal, regulatory and safety-related requirements concerning their products and any use of TI products in such safety-critical applications, notwithstanding any applications-related information or support that may be provided by TI. Further, Buyers must fully indemnify TI and its representatives against any damages arising out of the use of TI products in such safety-critical applications.

TI products are neither designed nor intended for use in military/aerospace applications or environments unless the TI products are specifically designated by TI as military-grade or "enhanced plastic." Only products designated by TI as military-grade meet military specifications. Buyers acknowledge and agree that any such use of TI products which TI has not designated as military-grade is solely at the Buyer's risk, and that they are solely responsible for compliance with all legal and regulatory requirements in connection with such use.

TI products are neither designed nor intended for use in automotive applications or environments unless the specific TI products are designated by TI as compliant with ISO/TS 16949 requirements. Buyers acknowledge and agree that, if they use any non-designated products in automotive applications, TI will not be responsible for any failure to meet such requirements.

Following are URLs where you can obtain information on other Texas Instruments products and application solutions:

Products

Amplifiers	amplifier.ti.com
Data Converters	dataconverter.ti.com
DSP	dsp.ti.com
Clocks and Timers	www.ti.com/clocks
Interface	interface.ti.com
Logic	logic.ti.com
Power Mgmt	power.ti.com
Microcontrollers	microcontroller.ti.com
RFID	www.ti-rfid.com
RF/IF and ZigBee® Solutions	www.ti.com/lprf

Applications

Audio	www.ti.com/audio
Automotive	www.ti.com/automotive
Broadband	www.ti.com/broadband
Digital Control	www.ti.com/digitalcontrol
Medical	www.ti.com/medical
Military	www.ti.com/military
Optical Networking	www.ti.com/opticalnetwork
Security	www.ti.com/security
Telephony	www.ti.com/telephony
Video & Imaging	www.ti.com/video
Wireless	www.ti.com/wireless

Mailing Address: Texas Instruments, Post Office Box 655303, Dallas, Texas 75265
Copyright © 2008, Texas Instruments Incorporated