

N ATTENUATOR

8 DB 12.4 GHZ 2W

R414.708.000

Series : ATTENUATOR

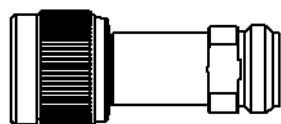
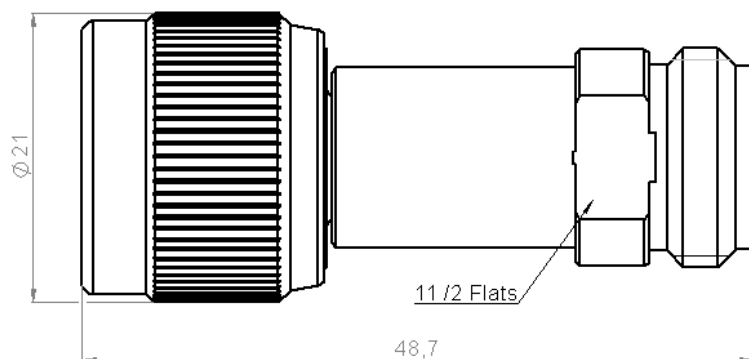

SCALE 1/1

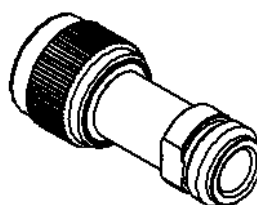

All dimensions are in mm.

COMPONENTS	MATERIALS	PLATING(μm)
BODY	BRASS	NICKEL 5
MALE CENTER CONTACT	BERYLLIUM COPPER	GOLD 2.5 OVER NICKEL 1
FEMALE CENTER CONTACT	BERYLLIUM COPPER	GOLD 2.5 OVER NICKEL 1
OUTER CONTACT		
INSULATOR	PTFE	
GASKET	SILICONE RUBBER	
SUBSTRATE	ALUMINA	
RESISTOR	Thin film	
OTHERS PARTS		

Issue : 0823 F

In the effort to improve our products, we reserve the right to make changes judged to be necessary.

N ATTENUATOR

R414.708.000

8 DB 12.4 GHZ 2W

Series : ATTENUATOR

ELECTRICAL CHARACTERISTICS

Frequency (GHz)	DC - 4	4 - 8	8 - 12.4	
V.S.W.R (≤)	1.15	1.20	1.25	
Deviation(±dB)	0.30	0.50	0.70	
Operating Frequency Range	DC - 12.4			GHz
Impedance	50			Ω
Nominal Attenuation	8			dB
Peak power at 25°C (1μs, 1%)	100			W
Average power at 25°C	2			W (Free Air Cooled) W (Conduction Cooled)

MECHANICAL CHARACTERISTICS

Connectors	N	Male Female	MIL-C 39012
Weight	59,6200	g	

ENVIRONMENTAL CHARACTERISTICS

Operating temperature range	-55 /+125 °C
Storage temperature range	-55 /+125 °C

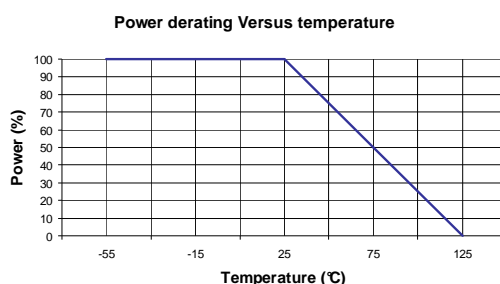

SPECIFICATION

OTHER CHARACTERISTICS

Issue : 0823 F

In the effort to improve our products, we reserve the right to make changes judged to be necessary.