

**OBSOLETE PRODUCT
POSSIBLE SUBSTITUTE PRODUCT
EL2480, EL5455**

Quad, 560MHz, Low Power, Video Operational Amplifier

The HFA1405 is a quad, high speed, low power current feedback amplifier built with Intersil's proprietary complementary bipolar UHF-1 process.

These amplifiers deliver up to 560MHz bandwidth and 2500V/ μ s slew rate, on only 58mW of quiescent power. They are specifically designed to meet the performance, power, and cost requirements of high volume video applications. The excellent gain flatness and differential gain/phase performance make these amplifiers well suited for component or composite video applications. Video performance is maintained even when driving a back terminated cable ($R_L = 150\Omega$), and degrades only slightly when driving two back terminated cables ($R_L = 75\Omega$). RGB applications will benefit from the high slew rates, and high full power bandwidth.

The HFA1405 is a pin compatible, low power, high performance upgrade for the popular Intersil HA5025, and for the CLC414 and CLC415.

Part # Information

PART NUMBER	TEMP. RANGE (°C)	PACKAGE	PKG. DWG. #
HFA1405IB	-40 to 85	14 Ld SOIC	M14.15
HFA1405IP	-40 to 85	14 Ld PDIP	E14.3
HA5025EVAL	High Speed Op Amp DIP Evaluation Board		

Features

- Low Supply Current 5.8mA/Op Amp
- High Input Impedance 1M Ω
- Wide -3dB Bandwidth ($A_V = +2$) 560MHz
- Very Fast Slew Rate 2500V/ μ s
- Gain Flatness (to 50MHz). ± 0.03 dB
- Differential Gain 0.02%
- Differential Phase. 0.03 Degrees
- All Hostile Crosstalk (5MHz) -60dB
- Pin Compatible Upgrade to HA5025, CLC414, and CLC415

Applications

- Flash A/D Drivers
- Professional Video Processing
- Video Digitizing Boards/Systems
- Multimedia Systems
- RGB Preamps
- Medical Imaging
- Hand Held and Miniaturized RF Equipment
- Battery Powered Communications
- High Speed Oscilloscopes and Analyzers

Related Literature

- Technical Brief TB363 "Guidelines for Handling and Processing Moisture Sensitive Surface Mount Devices (SMDs)"

Pinout

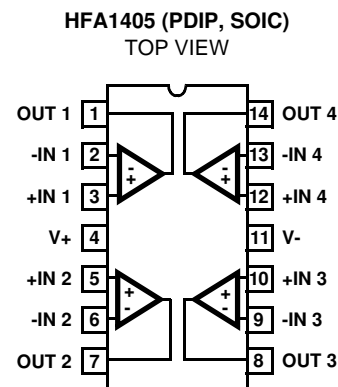

HFA1405

Absolute Maximum Ratings $T_A = 25^\circ\text{C}$

Voltage Between V+ and V-	11V
DC Input Voltage	V_{SUPPLY}
Differential Input Voltage	5V
Output Current (Note 2)	Short Circuit Protected
	30mA Continuous
	60mA \leq 50% Duty Cycle

ESD Rating

Human Body Model (Per MIL-STD-883 Method 3015.7) . . . 600V

Thermal Information

Thermal Resistance (Typical, Note 1)	θ_{JA} ($^\circ\text{C}/\text{W}$)
SOIC Package	120
PDIP Package	90
Maximum Junction Temperature (Die)	175 $^\circ\text{C}$
Maximum Junction Temperature (Plastic Package)	150 $^\circ\text{C}$
Maximum Storage Temperature Range	-65 $^\circ\text{C}$ to 150 $^\circ\text{C}$
Maximum Lead Temperature (Soldering 10s)	300 $^\circ\text{C}$ (SOIC - Lead Tips Only)

Operating Conditions

Temperature Range

CAUTION: Stresses above those listed in "Absolute Maximum Ratings" may cause permanent damage to the device. This is a stress only rating and operation of the device at these or any other conditions above those indicated in the operational sections of this specification is not implied.

NOTES:

- θ_{JA} is measured with the component mounted on a low effective thermal conductivity test board in free air. See Tech Brief TB379 for details.
- Output is short circuit protected to ground. Brief short circuits to ground will not degrade reliability, however continuous (100% duty cycle) output current must not exceed 30mA for maximum reliability.

Electrical Specifications $V_{\text{SUPPLY}} = \pm 5\text{V}$, $A_V = +1$, $R_F = 510\Omega$, $R_L = 100\Omega$, Unless Otherwise Specified

PARAMETER	TEST CONDITIONS	(NOTE 4) TEST LEVEL	TEMP ($^\circ\text{C}$)	HFA1405IB (SOIC)			HFA1405IP (PDIP)			UNITS
				MIN	TYP	MAX	MIN	TYP	MAX	
INPUT CHARACTERISTICS										
Input Offset Voltage		A	25	-	2	5	-	2	5	mV
		A	Full	-	3	8	-	3	8	mV
Average Input Offset Voltage Drift		B	Full	-	1	10	-	1	10	$\mu\text{V}/^\circ\text{C}$
Input Offset Voltage Common-Mode Rejection Ratio	$\Delta V_{\text{CM}} = \pm 1.8\text{V}$	A	25	45	48	-	45	48	-	dB
	$\Delta V_{\text{CM}} = \pm 1.8\text{V}$	A	85	43	46	-	43	46	-	dB
	$\Delta V_{\text{CM}} = \pm 1.2\text{V}$	A	-40	43	46	-	43	46	-	dB
Input Offset Voltage Power Supply Rejection Ratio	$\Delta V_{\text{PS}} = \pm 1.8\text{V}$	A	25	48	52	-	48	52	-	dB
	$\Delta V_{\text{PS}} = \pm 1.8\text{V}$	A	85	46	48	-	46	48	-	dB
	$\Delta V_{\text{PS}} = \pm 1.2\text{V}$	A	-40	46	48	-	46	48	-	dB
Non-Inverting Input Bias Current		A	25	-	6	15	-	6	15	μA
		A	Full	-	10	25	-	10	25	μA
Non-Inverting Input Bias Current Drift		B	Full	-	5	60	-	5	60	$\text{nA}/^\circ\text{C}$
Non-Inverting Input Bias Current Power Supply Sensitivity	$\Delta V_{\text{PS}} = \pm 1.8\text{V}$	A	25	-	0.5	1	-	0.5	1	$\mu\text{A}/\text{V}$
	$\Delta V_{\text{PS}} = \pm 1.8\text{V}$	A	85	-	0.8	3	-	0.8	3	$\mu\text{A}/\text{V}$
	$\Delta V_{\text{PS}} = \pm 1.2\text{V}$	A	-40	-	0.8	3	-	0.8	3	$\mu\text{A}/\text{V}$
Non-Inverting Input Resistance	$\Delta V_{\text{CM}} = \pm 1.8\text{V}$	A	25	0.8	1.2	-	0.8	1.2	-	$\text{M}\Omega$
	$\Delta V_{\text{CM}} = \pm 1.8\text{V}$	A	85	0.5	0.8	-	0.5	0.8	-	$\text{M}\Omega$
	$\Delta V_{\text{CM}} = \pm 1.2\text{V}$	A	-40	0.5	0.8	-	0.5	0.8	-	$\text{M}\Omega$
Inverting Input Bias Current		A	25	-	2	7.5	-	2	7.5	μA
		A	Full	-	5	15	-	5	15	μA
Inverting Input Bias Current Drift		B	Full	-	60	200	-	60	200	$\text{nA}/^\circ\text{C}$
Inverting Input Bias Current Common-Mode Sensitivity	$\Delta V_{\text{CM}} = \pm 1.8\text{V}$	A	25	-	3	6	-	3	6	$\mu\text{A}/\text{V}$
	$\Delta V_{\text{CM}} = \pm 1.8\text{V}$	A	85	-	4	8	-	4	8	$\mu\text{A}/\text{V}$
	$\Delta V_{\text{CM}} = \pm 1.2\text{V}$	A	-40	-	4	8	-	4	8	$\mu\text{A}/\text{V}$

HFA1405

Electrical Specifications $V_{SUPPLY} = \pm 5V$, $A_V = +1$, $R_F = 510\Omega$, $R_L = 100\Omega$, Unless Otherwise Specified (Continued)

PARAMETER	TEST CONDITIONS	(NOTE 4) TEST LEVEL	TEMP(°C)	HFA1405IB (SOIC)			HFA1405IP (PDIP)			UNITS
				MIN	TYP	MAX	MIN	TYP	MAX	
Inverting Input Bias Current Power Supply Sensitivity	$\Delta V_{PS} = \pm 1.8V$	A	25	-	2	5	-	2	5	$\mu A/V$
	$\Delta V_{PS} = \pm 1.8V$	A	85	-	4	8	-	4	8	$\mu A/V$
	$\Delta V_{PS} = \pm 1.2V$	A	-40	-	4	8	-	4	8	$\mu A/V$
Inverting Input Resistance		C	25	-	60	-	-	60	-	Ω
Input Capacitance		B	25	-	1.4	-	-	2.2	-	pF
Input Voltage Common Mode Range (Implied by V_{IO} CMRR, $+R_{IN}$, and $-I_{B-IAS}$ CMS Tests)		A	25, 85	± 1.8	± 2.4	-	± 1.8	± 2.4	-	V
		A	-40	± 1.2	± 1.7	-	± 1.2	± 1.7	-	V
Input Noise Voltage Density	f = 100kHz	B	25	-	3.5	-	-	3.5	-	nV/\sqrt{Hz}
Non-Inverting Input Noise Current Density	f = 100kHz	B	25	-	2.5	-	-	2.5	-	pA/\sqrt{Hz}
Inverting Input Noise Current Density	f = 100kHz	B	25	-	20	-	-	20	-	pA/\sqrt{Hz}
TRANSFER CHARACTERISTICS										
Open Loop Transimpedance Gain	$A_V = -1$	C	25	-	500	-	-	500	-	k Ω
AC CHARACTERISTICS (Note 3)										
-3dB Bandwidth ($V_{OUT} = 0.2V_{P-P}$, Notes 3, 5)	$A_V = -1$	B	25	-	420	-	-	360	-	MHz
	$A_V = +2$	B	25	-	560	-	-	400	-	MHz
	$A_V = +6$	B	25	-	140	-	-	100	-	MHz
Full Power Bandwidth ($V_{OUT} = 5V_{P-P}$, Notes 3, 5)	$A_V = -1$	B	25	-	260	-	-	260	-	MHz
	$A_V = +2$	B	25	-	165	-	-	165	-	MHz
	$A_V = +6$	B	25	-	140	-	-	100	-	MHz
Gain Flatness ($V_{OUT} = 0.2V_{P-P}$, Notes 3, 5)	$A_V = -1$, 25MHz	B	25	-	± 0.03	-	-	± 0.04	-	dB
	$A_V = -1$, 50MHz	B	25	-	± 0.04	-	-	± 0.04	-	dB
	$A_V = -1$, 100MHz	B	25	-	± 0.09	-	-	± 0.06	-	dB
	$A_V = +2$, 25MHz	B	25	-	± 0.03	-	-	± 0.04	-	dB
	$A_V = +2$, 50MHz	B	25	-	± 0.03	-	-	± 0.04	-	dB
	$A_V = +2$, 100MHz	B	25	-	± 0.07	-	-	± 0.06	-	dB
	$A_V = +6$, 15MHz	B	25	-	± 0.08	-	-	± 0.08	-	dB
	$A_V = +6$, 30MHz	B	25	-	± 0.19	-	-	± 0.27	-	dB
Minimum Stable Gain		A	Full	-	1	-	-	1	-	V/V
Crosstalk ($A_V = +1$, All Channels Hostile, Note 5)	5MHz	B	25	-	-60	-	-	-55	-	dB
	10MHz	B	25	-	-56	-	-	-52	-	dB
OUTPUT CHARACTERISTICS $A_V = +2$ (Note 3), Unless Otherwise Specified										
Output Voltage Swing (Note 5)	$A_V = -1$, $R_L = 100\Omega$	A	25	± 3	± 3.4	-	± 3	± 3.4	-	V
		A	Full	± 2.8	± 3	-	± 2.8	± 3	-	V
Output Current (Note 5)	$A_V = -1$, $R_L = 50\Omega$	A	25, 85	50	60	-	50	60	-	mA
		A	-40	28	42	-	28	42	-	mA
Output Short Circuit Current		B	25	-	90	-	-	90	-	mA
Closed Loop Output Impedance		B	25	-	0.2	-	-	0.2	-	Ω
Second Harmonic Distortion ($V_{OUT} = 2V_{P-P}$, Note 5)	10MHz	B	25	-	-51	-	-	-51	-	dBc
	20MHz	B	25	-	-46	-	-	-46	-	dBc
Third Harmonic Distortion ($V_{OUT} = 2V_{P-P}$, Note 5)	10MHz	B	25	-	-63	-	-	-63	-	dBc
	20MHz	B	25	-	-56	-	-	-56	-	dBc

HFA1405

Electrical Specifications $V_{SUPPLY} = \pm 5V$, $A_V = +1$, $R_F = 510\Omega$, $R_L = 100\Omega$, Unless Otherwise Specified (Continued)

PARAMETER	TEST CONDITIONS	(NOTE 4) TEST LEVEL	TEMP(°C)	HFA1405IB (SOIC)			HFA1405IP (PDIP)			UNITS
				MIN	TYP	MAX	MIN	TYP	MAX	
TRANSIENT CHARACTERISTICS $A_V = +2$ (Note 3), Unless Otherwise Specified										
Rise and Fall Times ($V_{OUT} = 0.5V_{P-P}$, Note 3)	$A_V = +2$	B	25	-	0.8	-	-	0.9	-	ns
	$A_V = +6$	B	25	-	2.9	-	-	4	-	ns
Overshoot ($V_{OUT} = 0.5V_{P-P}$, V_{IN} $t_{RISE} = 1ns$, Notes 3, 6)	$A_V = -1, +OS$	B	25	-	7	-	-	3	-	%
	$A_V = -1, -OS$	B	25	-	8	-	-	13	-	%
	$A_V = +2, +OS$	B	25	-	5	-	-	7	-	%
	$A_V = +2, -OS$	B	25	-	10	-	-	11	-	%
	$A_V = +6, +OS$	B	25	-	2	-	-	2	-	%
	$A_V = +6, -OS$	B	25	-	2	-	-	2	-	%
Slew Rate ($V_{OUT} = 5V_{P-P}$, Notes 3, 5)	$A_V = -1, +SR$	B	25	-	2500	-	-	2500	-	V/ μs
	$A_V = -1, -SR$	B	25	-	1900	-	-	1900	-	V/ μs
	$A_V = +2, +SR$	B	25	-	1700	-	-	1600	-	V/ μs
	$A_V = +2, -SR$	B	25	-	1700	-	-	1400	-	V/ μs
	$A_V = +6, +SR$	B	25	-	1500	-	-	1000	-	V/ μs
	$A_V = +6, -SR$	B	25	-	1100	-	-	1000	-	V/ μs
Settling Time ($V_{OUT} = +2V$ to $0V$ Step, Note 5)	To 0.1%	B	25	-	23	-	-	23	-	ns
	To 0.05%	B	25	-	30	-	-	30	-	ns
	To 0.025%	B	25	-	37	-	-	40	-	ns
Overdrive Recovery Time	$V_{IN} = \pm 2V$	B	25	-	8.5	-	-	8.5	-	ns
VIDEO CHARACTERISTICS $A_V = +2$ (Note 3), Unless Otherwise Specified										
Differential Gain ($f = 3.58MHz$)	$R_L = 150\Omega$	B	25	-	0.02	-	-	0.03	-	%
	$R_L = 75\Omega$	B	25	-	0.03	-	-	0.06	-	%
Differential Phase ($f = 3.58MHz$)	$R_L = 150\Omega$	B	25	-	0.03	-	-	0.03	-	Degrees
	$R_L = 75\Omega$	B	25	-	0.06	-	-	0.06	-	Degrees
POWER SUPPLY CHARACTERISTICS										
Power Supply Range		C	25	± 4.5	-	± 5.5	± 4.5	-	± 5.5	V
Power Supply Current (Note 5)		A	25	-	5.8	6.1	-	5.8	6.1	mA/Op Amp
		A	Full	-	5.9	6.3	-	5.9	6.3	mA/Op Amp

NOTES:

- The optimum feedback resistor depends on closed loop gain and package type. See the "Optimum Feedback Resistor" table in the Application Information section for details.
- Test Level: A. Production Tested; B. Typical or Guaranteed Limit Based on Characterization; C. Design Typical for Information Only.
- See Typical Performance Curves for more information.
- Undershoot dominates for output signal swings below GND (e.g., $2V_{P-P}$), yielding a higher overshoot limit compared to the $V_{OUT} = 0V$ to $2V$ condition. See the "Application Information" section for details.

Application Information

Performance Differences Between Packages

The amplifiers comprising the HFA1405 are high frequency current feedback amplifiers. As such, they are sensitive to feedback capacitance which destabilizes the op amp and causes overshoot and peaking. Unfortunately, the standard quad op amp pinout places the amplifier's output next to its inverting input, thus making the package capacitance an unavoidable parasitic feedback capacitor. The larger

parasitic capacitance of the PDIP requires an inherently more stable amplifier, which yields a PDIP device with lower performance than the SOIC device - see Electrical Specification tables for details.

Because of these performance differences, designers should evaluate and breadboard with the same package style to be used in production.

Note that the "Typical Performance Curves" section has separate pulse and frequency response graphs for each

package type. Graphs not labeled with a specific package type are applicable to all packages.

Optimum Feedback Resistor

Although a current feedback amplifier's bandwidth dependency on closed loop gain isn't as severe as that of a voltage feedback amplifier, there can be an appreciable decrease in bandwidth at higher gains. This decrease may be minimized by taking advantage of the current feedback amplifier's unique relationship between bandwidth and R_F . All current feedback amplifiers require a feedback resistor, even for unity gain applications, and R_F , in conjunction with the internal compensation capacitor, sets the dominant pole of the frequency response. Thus, the amplifier's bandwidth is inversely proportional to R_F . The HFA1405 design is optimized for $R_F = 402\Omega/510\Omega$ (PDIP/SOIC) at a gain of +2. Decreasing R_F decreases stability, resulting in excessive peaking and overshoot (Note: Capacitive feedback causes the same problems due to the feedback impedance decrease at higher frequencies). However, at higher gains the amplifier is more stable so R_F can be decreased in a trade-off of stability for bandwidth.

The table below lists recommended R_F values for various gains, and the expected bandwidth. For good channel-to-channel gain matching, it is recommended that all resistors (termination as well as gain setting) be $\pm 1\%$ tolerance or better.

TABLE 1. OPTIMUM FEEDBACK RESISTOR

GAIN (ACL)	R_F (Ω) PDIP/SOIC	BANDWIDTH (MHz) PDIP/SOIC
-1	310/360	360/420
+1	510 (+ $R_S = 510$)/ 464 (+ $R_S = 649$)	300/375
+2	402/510	400/560
+5	NA/200	NA/330
+6	500/500 (Note)	100/140
+10	NA/180	NA/140

NOTE: $R_F = 500\Omega$ is not the optimum value. It was chosen to match the R_F of the CLC414 and CLC415, for performance comparison purposes. Performance at $A_V = +6$ may be increased by reducing R_F below 500Ω .

Non-inverting Input Source Impedance

For best operation, the DC source impedance seen by the non-inverting input should be $\geq 50\Omega$. This is especially important in inverting gain configurations where the non-inverting input would normally be connected directly to GND.

Pulse Undershoot

The HFA1405 utilizes a quasi-complementary output stage to achieve high output current while minimizing quiescent supply current. In this approach, a composite device replaces the traditional PNP pull-down transistor. The composite device switches modes after crossing 0V,

resulting in added distortion for signals swinging below ground, and an increased undershoot on the negative portion of the output waveform (see Figure 6 and Figure 9). This undershoot isn't present for small bipolar signals, or large positive signals (see Figure 4 and Figure 5).

PC Board Layout

The frequency response of this amplifier depends greatly on the amount of care taken in designing the PC board. **The use of low inductance components such as chip resistors and chip capacitors is strongly recommended, while a solid ground plane is a must!**

Attention should be given to decoupling the power supplies. A large value ($10\mu\text{F}$) tantalum in parallel with a small value ($0.1\mu\text{F}$) chip capacitor works well in most cases.

Terminated microstrip signal lines are recommended at the input and output of the device. Capacitance, parasitic or planned, connected to the output must be minimized, or isolated as discussed in the next section.

Care must also be taken to minimize the capacitance to ground at the amplifier's inverting input (-IN). The larger this capacitance, the worse the gain peaking, resulting in pulse overshoot and eventual instability. To reduce this capacitance the designer should remove the ground plane under traces connected to -IN, and keep connections to -IN as short as possible.

An example of a good high frequency layout is the Evaluation Board shown in Figure 3.

Driving Capacitive Loads

Capacitive loads, such as an A/D input, or an improperly terminated transmission line will degrade the amplifier's phase margin resulting in frequency response peaking and possible oscillations. In most cases, the oscillation can be avoided by placing a resistor (R_S) in series with the output prior to the capacitance.

Figure 1 details starting points for the selection of this resistor. The points on the curve indicate the R_S and C_L combinations for the optimum bandwidth, stability, and settling time, but experimental fine tuning is recommended. Picking a point above or to the right of the curve yields an overdamped response, while points below or left of the curve indicate areas of underdamped performance.

R_S and C_L form a low pass network at the output, thus limiting system bandwidth well below the amplifier bandwidth of 560MHz. By decreasing R_S as C_L increases (as illustrated in the curve), the maximum bandwidth is obtained without sacrificing stability. In spite of this, bandwidth still decreases as the load capacitance increases.

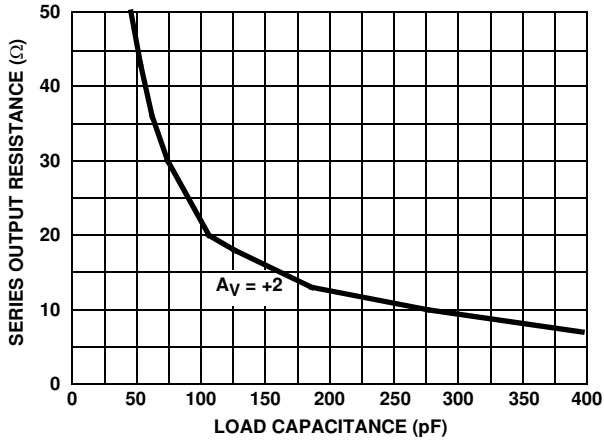

FIGURE 1. RECOMMENDED SERIES OUTPUT RESISTOR vs LOAD CAPACITANCE

Evaluation Board

The performance of the HFA1405 PDIP or SOIC can be evaluated using the HA5025 Evaluation Board. The HFA1405IB (SOIC) requires a SOIC to DIP adaptor like the Aries Electronics Part Number 14-350000-10.

The schematic for the PDIP/SOIC amplifier 1 and the HA5025EVAL board layout are shown in Figure 2 and Figure 3. Resistors R_F , R_G , and $+R_S$ may require a change to values applicable to the HFA1405.

To order evaluation board (part number HA5025EVAL), please contact your local sales office.

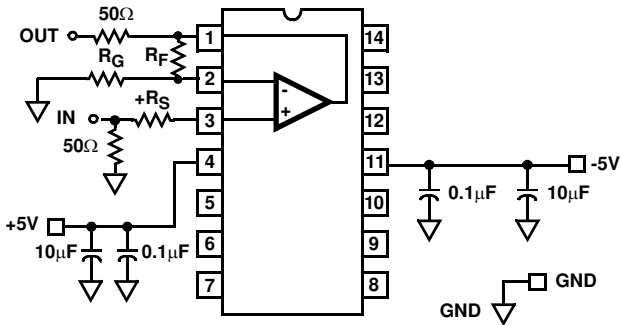
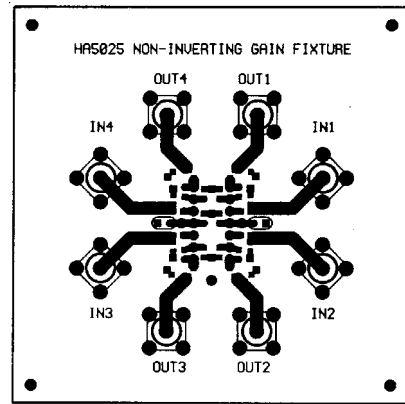

FIGURE 2. EVALUATION BOARD SCHEMATIC FOR PDIP/SOIC

TOP LAYOUT



BOTTOM LAYOUT

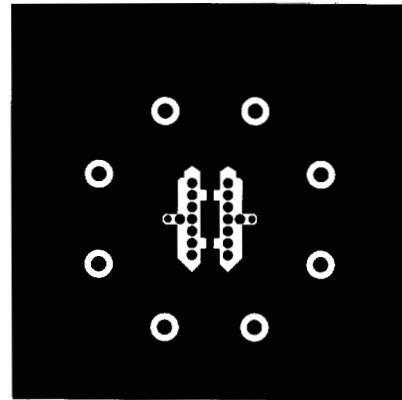

FIGURE 3. EVALUATION BOARD LAYOUT FOR PDIP/SOIC

Typical Performance Curves $V_{SUPPLY} = \pm 5V$, $T_A = 25^\circ C$, $R_F =$ Value From the Optimum Feedback Resistor Table,
 $R_L = 100\Omega$, Unless Otherwise Specified

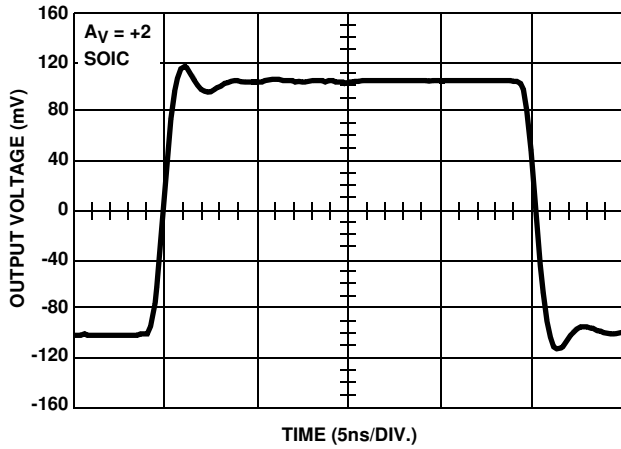

FIGURE 4. SMALL SIGNAL PULSE RESPONSE

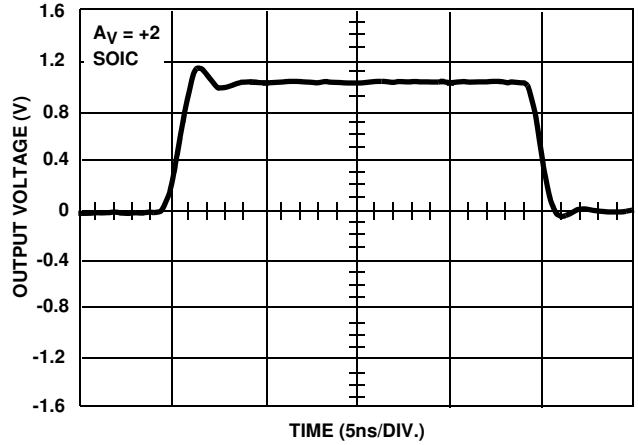

FIGURE 5. LARGE SIGNAL POSITIVE PULSE RESPONSE

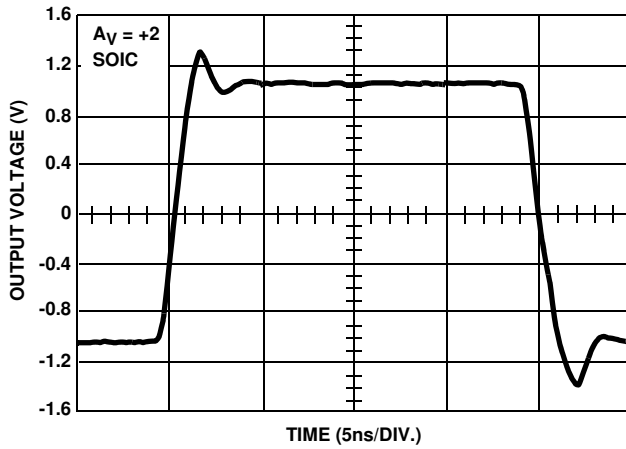

FIGURE 6. LARGE SIGNAL BIPOLAR PULSE RESPONSE

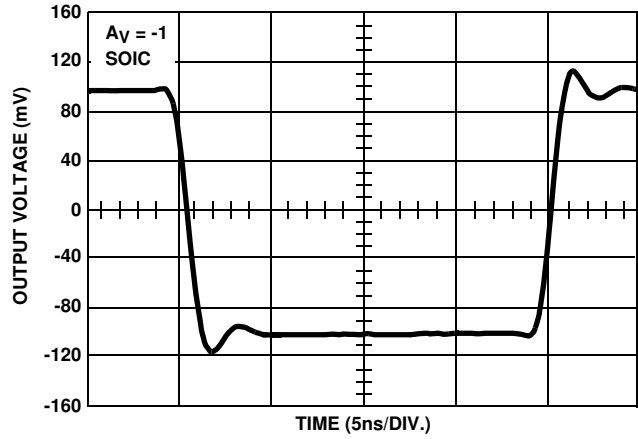

FIGURE 7. SMALL SIGNAL PULSE RESPONSE

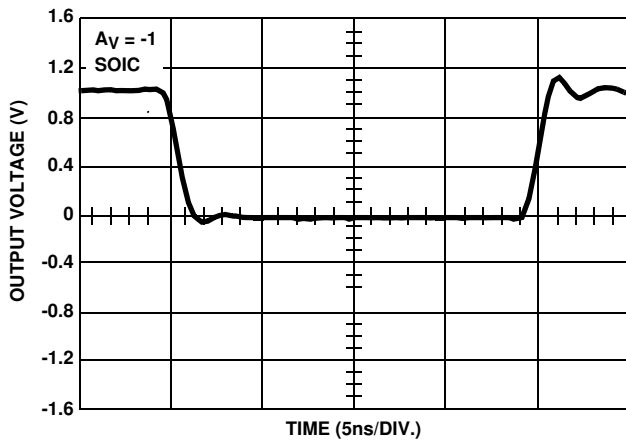

FIGURE 8. LARGE SIGNAL POSITIVE PULSE RESPONSE

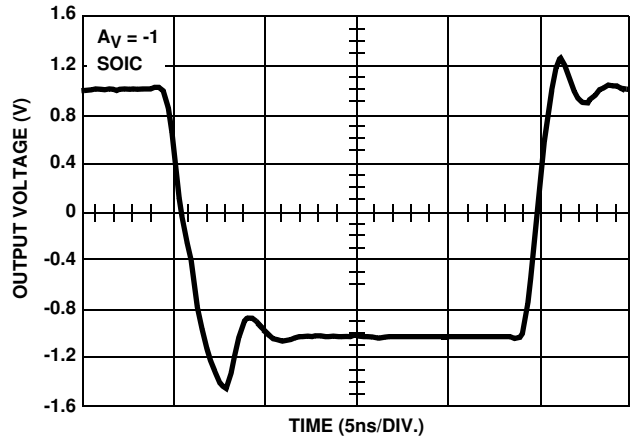

FIGURE 9. LARGE SIGNAL BIPOLAR PULSE RESPONSE

Typical Performance Curves $V_{SUPPLY} = \pm 5V$, $T_A = 25^\circ C$, $R_F =$ Value From the Optimum Feedback Resistor Table, $R_L = 100\Omega$, Unless Otherwise Specified (Continued)

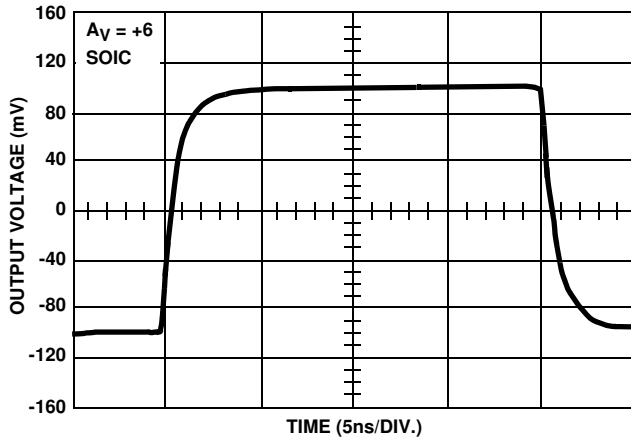

FIGURE 10. SMALL SIGNAL PULSE RESPONSE

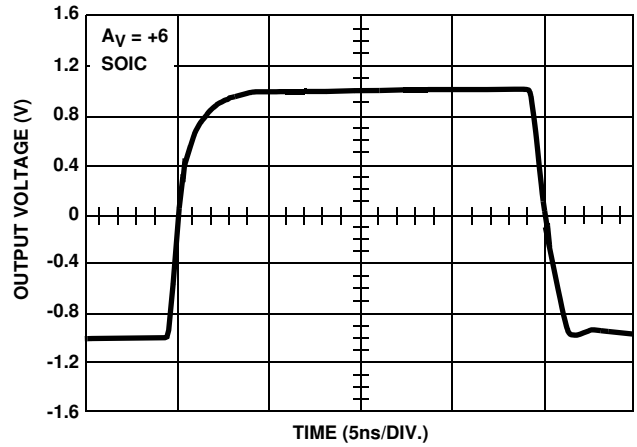

FIGURE 11. LARGE SIGNAL PULSE RESPONSE

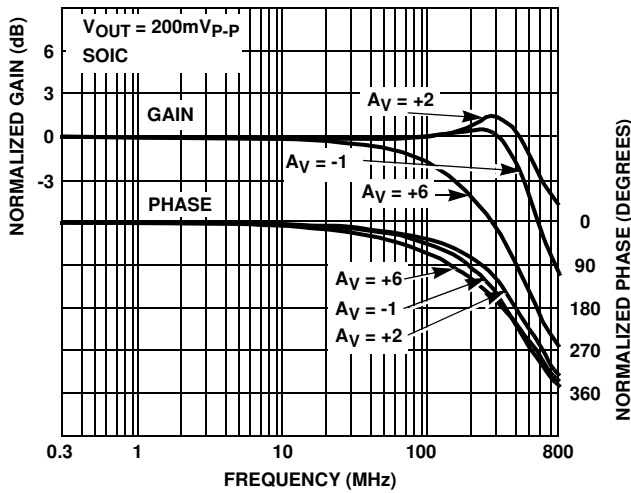

FIGURE 12. FREQUENCY RESPONSE

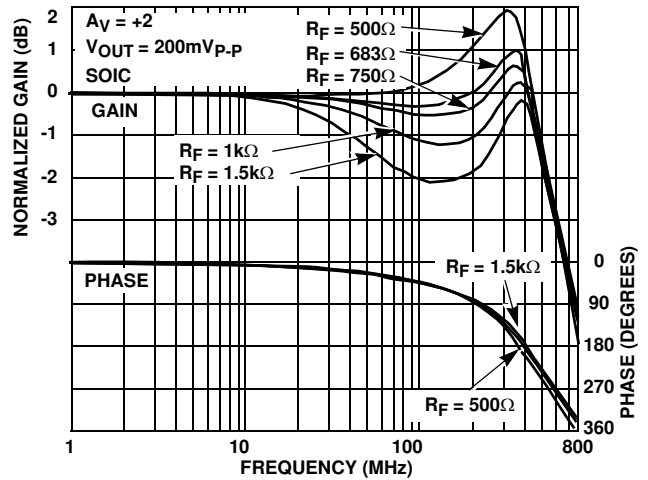

FIGURE 13. FREQUENCY RESPONSE vs FEEDBACK RESISTOR

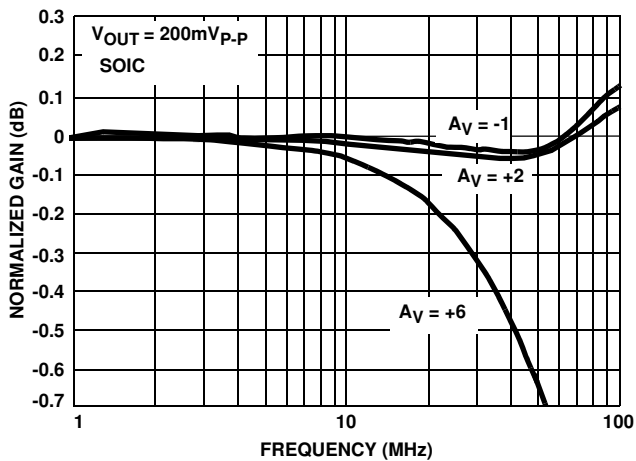

FIGURE 14. GAIN FLATNESS

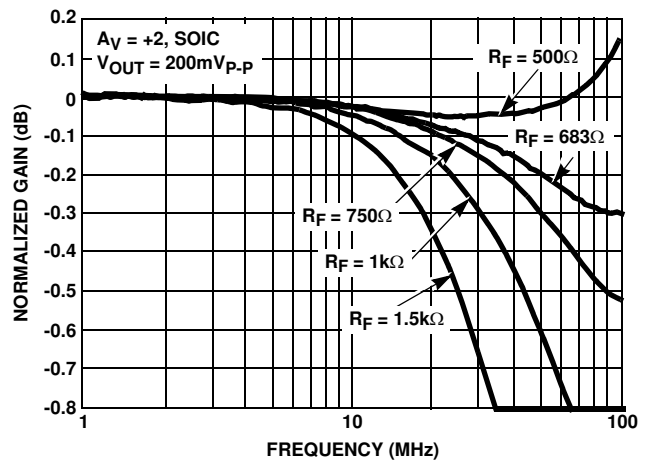

FIGURE 15. GAIN FLATNESS vs FEEDBACK RESISTOR

Typical Performance Curves $V_{SUPPLY} = \pm 5V$, $T_A = 25^\circ C$, $R_F =$ Value From the Optimum Feedback Resistor Table,
 $R_L = 100\Omega$, Unless Otherwise Specified (Continued)

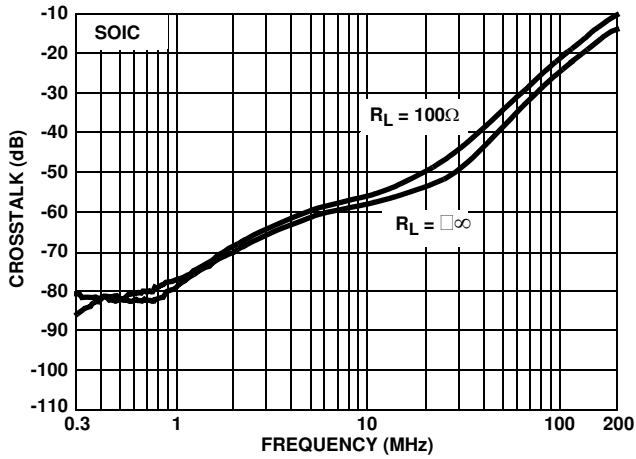

FIGURE 16. ALL HOSTILE CROSSTALK

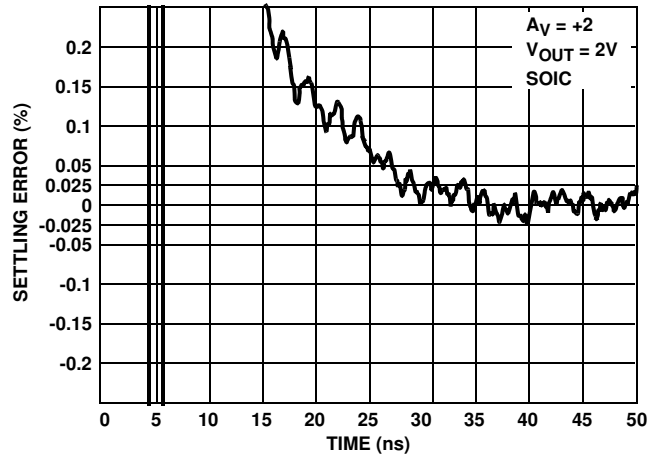

FIGURE 17. SETTLING RESPONSE

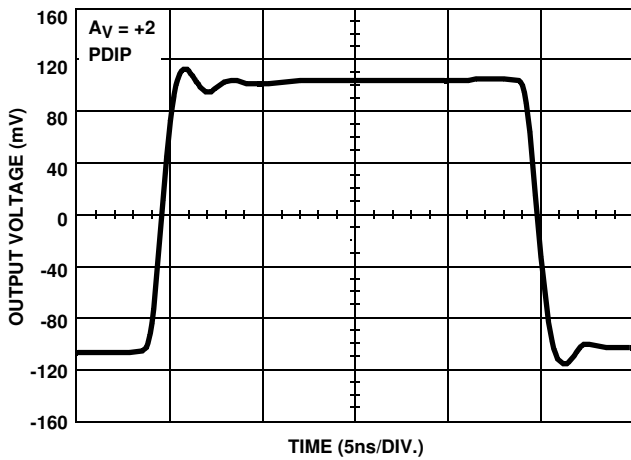

FIGURE 18. SMALL SIGNAL PULSE RESPONSE

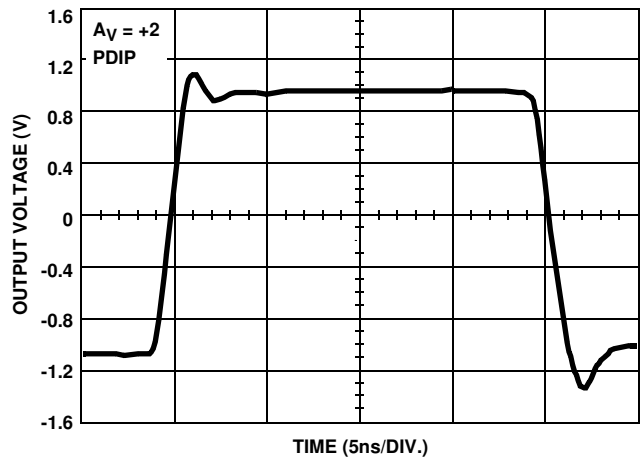

FIGURE 19. LARGE SIGNAL PULSE RESPONSE

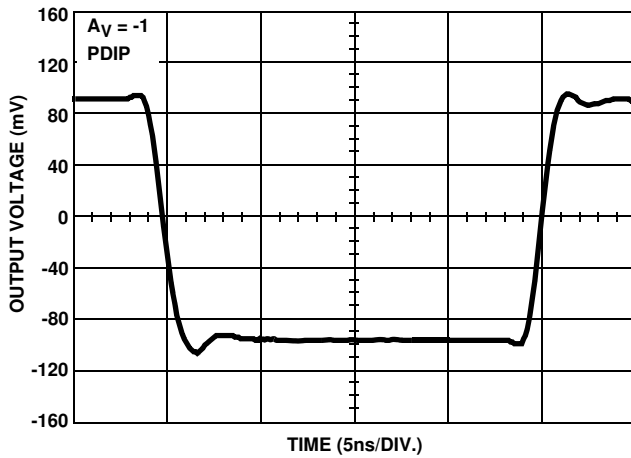

FIGURE 20. SMALL SIGNAL PULSE RESPONSE

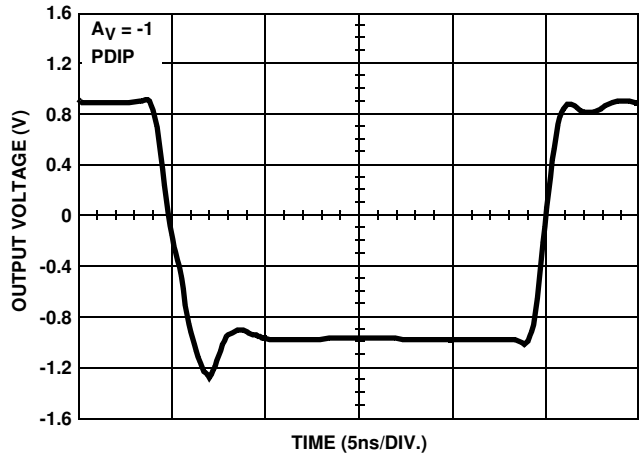

FIGURE 21. LARGE SIGNAL PULSE RESPONSE

Typical Performance Curves $V_{SUPPLY} = \pm 5V$, $T_A = 25^\circ C$, $R_F =$ Value From the Optimum Feedback Resistor Table,
 $R_L = 100\Omega$, Unless Otherwise Specified (Continued)

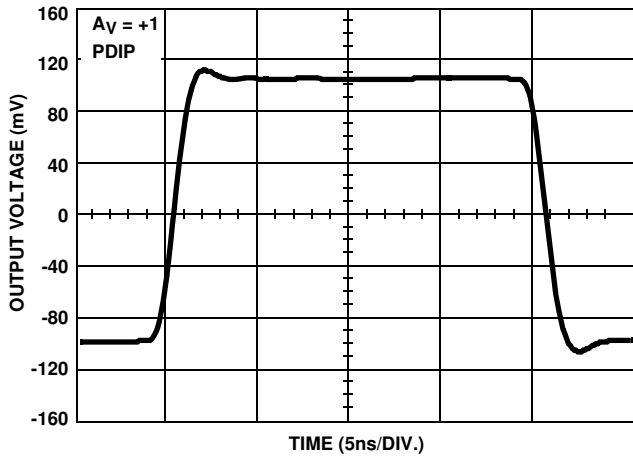

FIGURE 22. SMALL SIGNAL PULSE RESPONSE

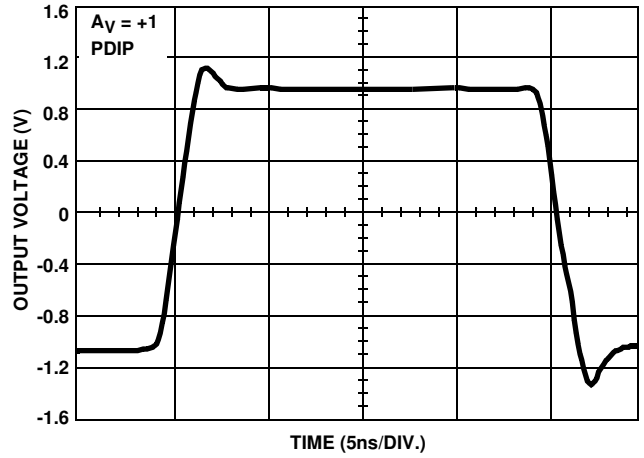

FIGURE 23. LARGE SIGNAL PULSE RESPONSE

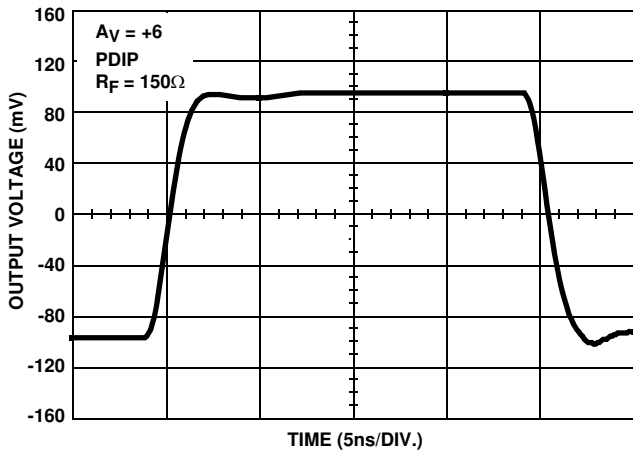

FIGURE 24. SMALL SIGNAL PULSE RESPONSE

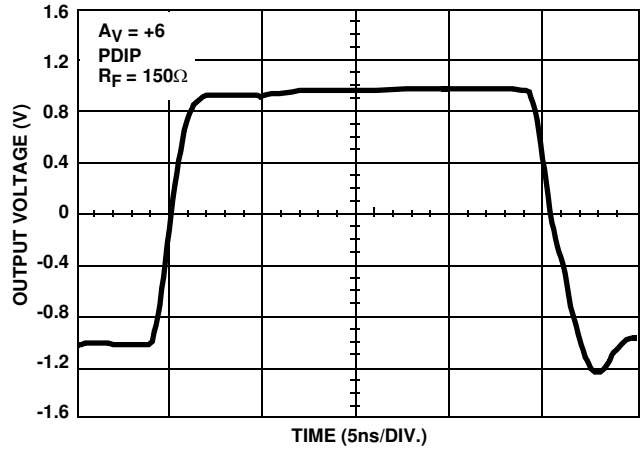

FIGURE 25. LARGE SIGNAL PULSE RESPONSE

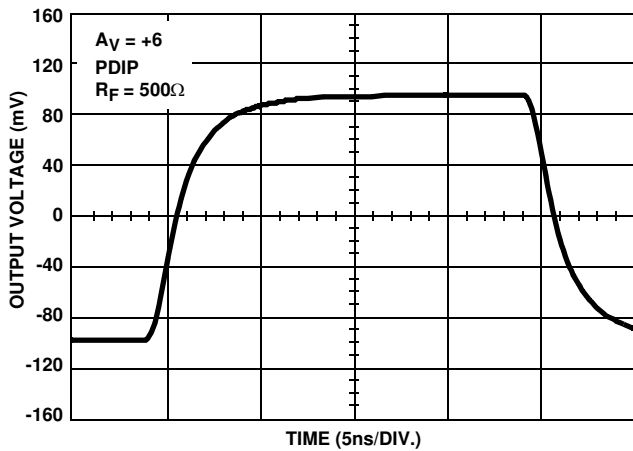

FIGURE 26. SMALL SIGNAL PULSE RESPONSE

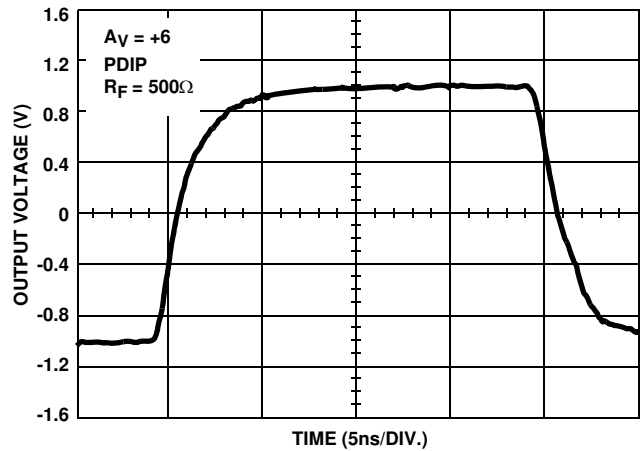

FIGURE 27. LARGE SIGNAL PULSE RESPONSE

Typical Performance Curves $V_{SUPPLY} = \pm 5V$, $T_A = 25^\circ C$, $R_F =$ Value From the Optimum Feedback Resistor Table,
 $R_L = 100\Omega$, Unless Otherwise Specified (Continued)

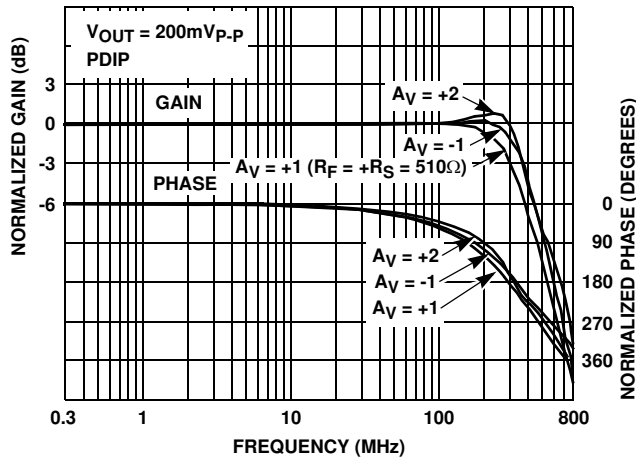

FIGURE 28. FREQUENCY RESPONSE

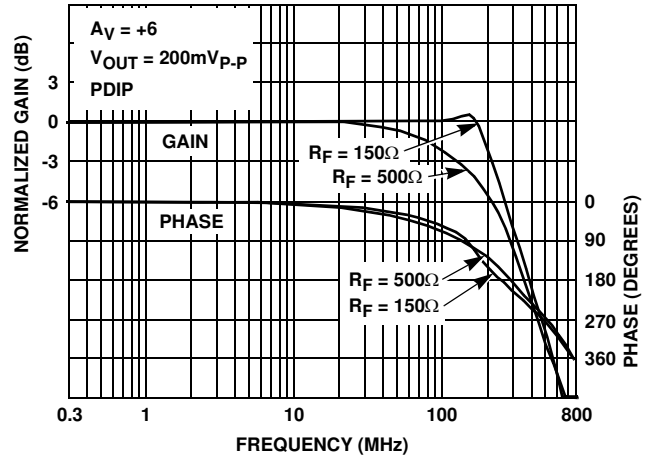

FIGURE 29. FREQUENCY RESPONSE

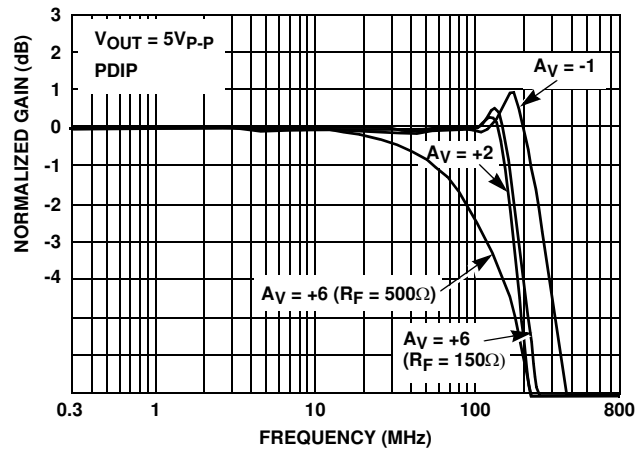

FIGURE 30. FULL POWER BANDWIDTH

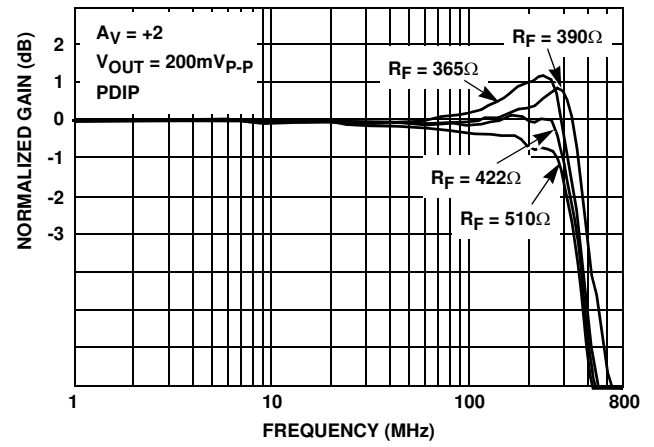

FIGURE 31. FREQUENCY RESPONSE vs FEEDBACK RESISTOR

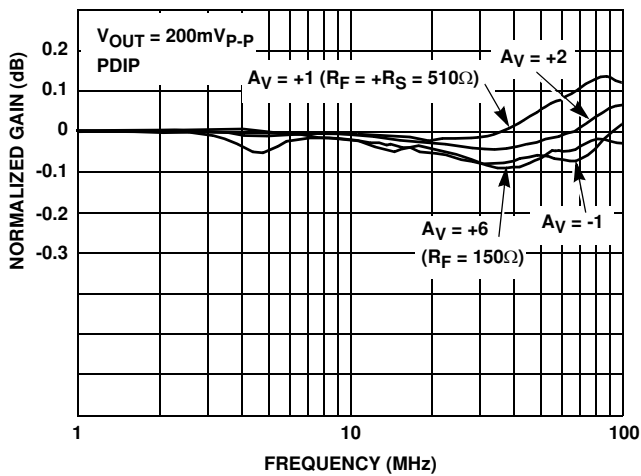

FIGURE 32. GAIN FLATNESS

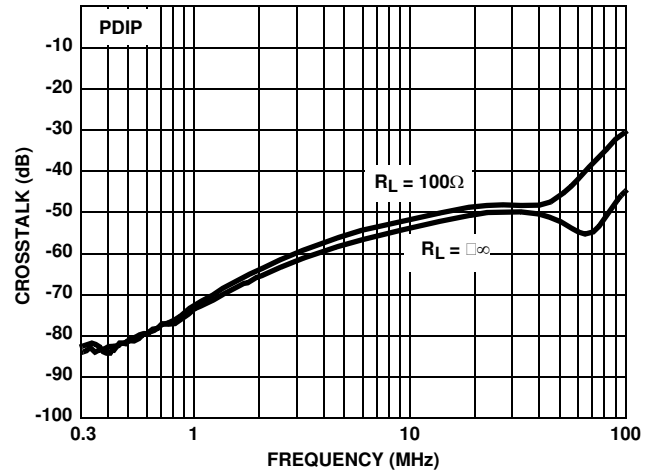

FIGURE 33. ALL HOSTILE CROSSTALK

Typical Performance Curves $V_{SUPPLY} = \pm 5V$, $T_A = 25^\circ C$, $R_F =$ Value From the Optimum Feedback Resistor Table,
 $R_L = 100\Omega$, Unless Otherwise Specified (Continued)

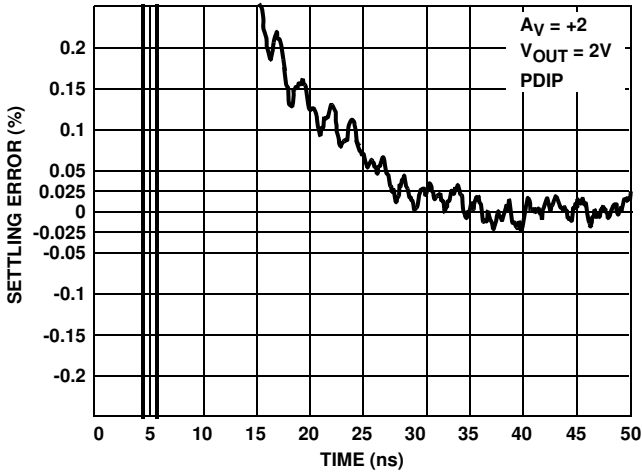

FIGURE 34. SETTLING RESPONSE

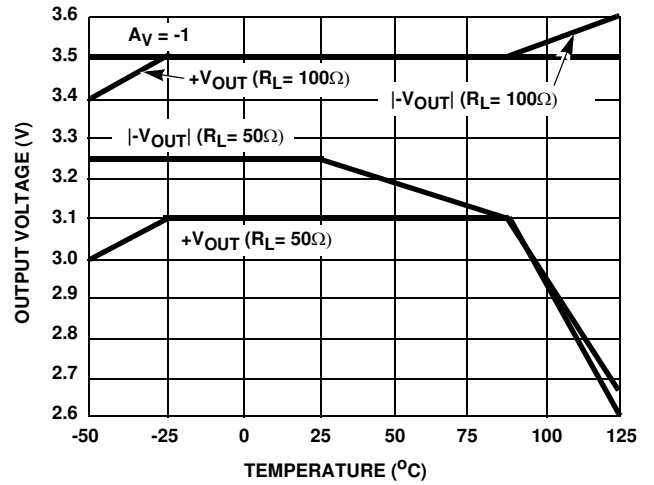

FIGURE 35. OUTPUT VOLTAGE vs TEMPERATURE

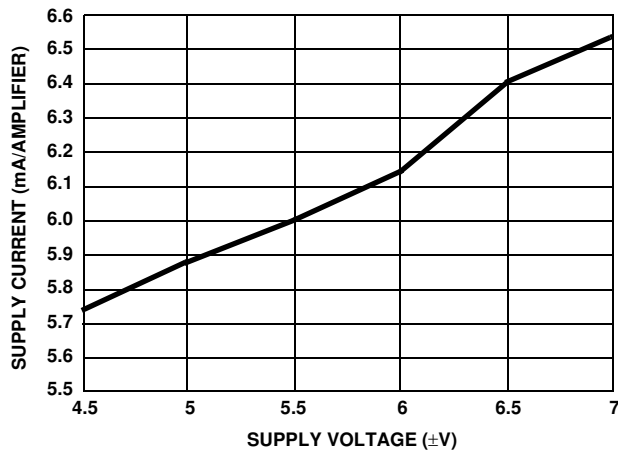

FIGURE 36. SUPPLY CURRENT vs SUPPLY VOLTAGE

Die Characteristics

DIE DIMENSIONS:

79 mils x 118 mils

2000 μ m x 3000 μ m

METALLIZATION:

Type: Metal 1: AlCu (2%)/TiW

Thickness: Metal 1: 8k \AA \pm 0.4k \AA

Type: Metal 2: AlCu (2%)

Thickness: Metal 2: 16k \AA \pm 0.8k \AA

SUBSTRATE POTENTIAL (POWERED UP):

Floating (Recommend Connection to V-)

PASSIVATION:

Type: Nitride

Thickness: 4k \AA \pm 0.5k \AA

TRANSISTOR COUNT:

320

Metallization Mask Layout

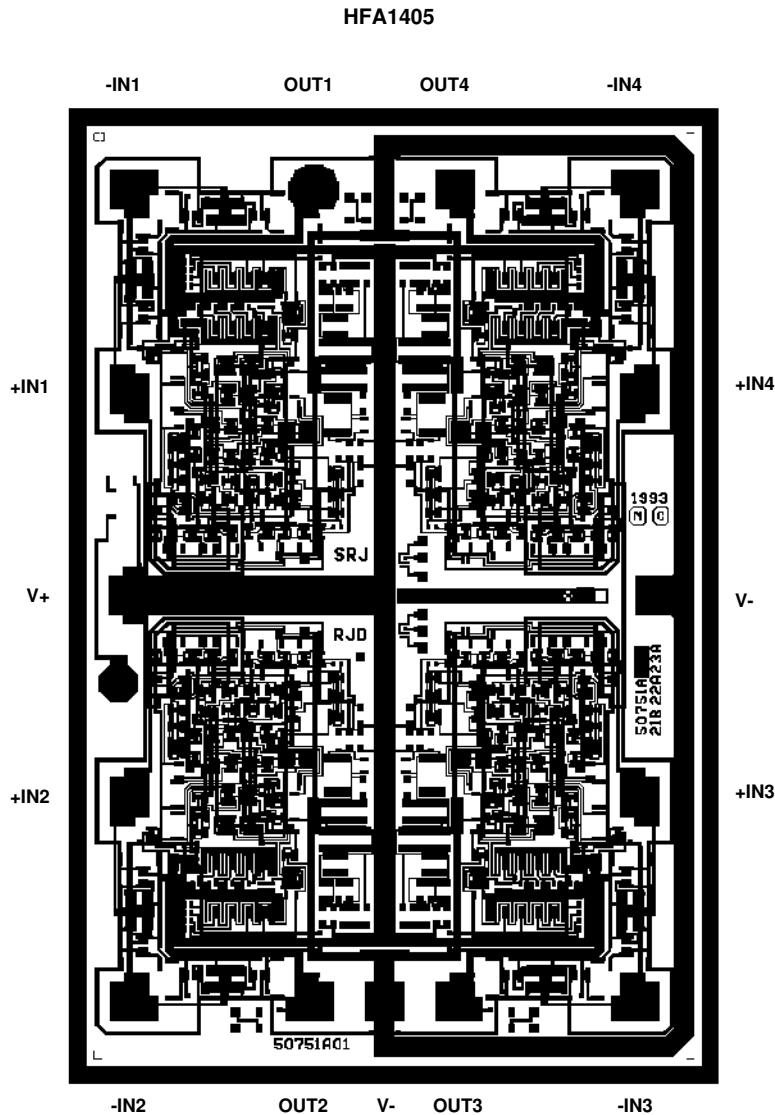

Small Outline Plastic Packages (SOIC)

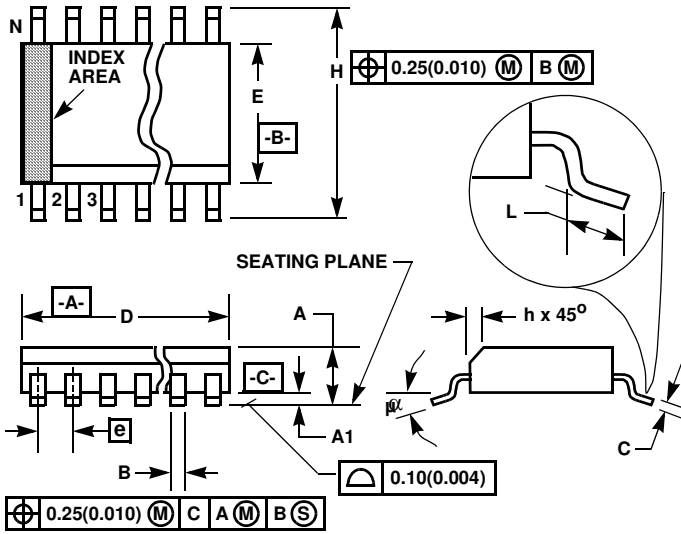

M14.15 (JEDEC MS-012-AB ISSUE C)
14 LEAD NARROW BODY SMALL OUTLINE PLASTIC PACKAGE

SYMBOL	INCHES		MILLIMETERS		NOTES
	MIN	MAX	MIN	MAX	
A	0.0532	0.0688	1.35	1.75	-
A1	0.0040	0.0098	0.10	0.25	-
B	0.013	0.020	0.33	0.51	9
C	0.0075	0.0098	0.19	0.25	-
D	0.3367	0.3444	8.55	8.75	3
E	0.1497	0.1574	3.80	4.00	4
e	0.050 BSC		1.27 BSC		-
H	0.2284	0.2440	5.80	6.20	-
h	0.0099	0.0196	0.25	0.50	5
L	0.016	0.050	0.40	1.27	6
N	14		14		7
α	0°	8°	0°	8°	-

NOTES:

1. Symbols are defined in the "MO Series Symbol List" in Section 2.2 of Publication Number 95.
2. Dimensioning and tolerancing per ANSI Y14.5M-1982.
3. Dimension "D" does not include mold flash, protrusions or gate burrs. Mold flash, protrusion and gate burrs shall not exceed 0.15mm (0.006 inch) per side.
4. Dimension "E" does not include interlead flash or protrusions. Interlead flash and protrusions shall not exceed 0.25mm (0.010 inch) per side.
5. The chamfer on the body is optional. If it is not present, a visual index feature must be located within the crosshatched area.
6. "L" is the length of terminal for soldering to a substrate.
7. "N" is the number of terminal positions.
8. Terminal numbers are shown for reference only.
9. The lead width "B", as measured 0.36mm (0.014 inch) or greater above the seating plane, shall not exceed a maximum value of 0.61mm (0.024 inch).
10. Controlling dimension: MILLIMETER. Converted inch dimensions are not necessarily exact.

Rev. 0 12/93

Dual-In-Line Plastic Packages (PDIP)

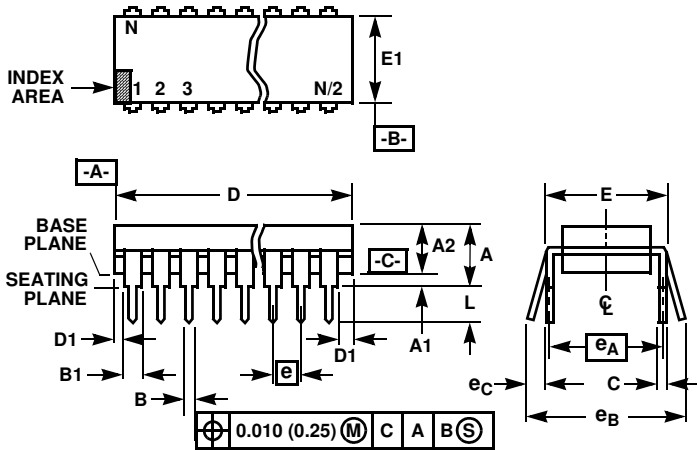

NOTES:

1. Controlling Dimensions: INCH. In case of conflict between English and Metric dimensions, the inch dimensions control.
2. Dimensioning and tolerancing per ANSI Y14.5M-1982.
3. Symbols are defined in the "MO Series Symbol List" in Section 2.2 of Publication No. 95.
4. Dimensions A, A1 and L are measured with the package seated in JEDEC seating plane gauge GS-3.
5. D, D1, and E1 dimensions do not include mold flash or protrusions. Mold flash or protrusions shall not exceed 0.010 inch (0.25mm).
6. E and e_A are measured with the leads constrained to be perpendicular to datum $-C-$.
7. e_B and e_C are measured at the lead tips with the leads unconstrained. e_C must be zero or greater.
8. B1 maximum dimensions do not include dambar protrusions. Dambar protrusions shall not exceed 0.010 inch (0.25mm).
9. N is the maximum number of terminal positions.
10. Corner leads (1, N, N/2 and N/2 + 1) for E8.3, E16.3, E18.3, E28.3, E42.6 will have a B1 dimension of 0.030 - 0.045 inch (0.76 - 1.14mm).

E14.3 (JEDEC MS-001-AA ISSUE D)
14 LEAD DUAL-IN-LINE PLASTIC PACKAGE

SYMBOL	INCHES		MILLIMETERS		NOTES
	MIN	MAX	MIN	MAX	
A	-	0.210	-	5.33	4
A1	0.015	-	0.39	-	4
A2	0.115	0.195	2.93	4.95	-
B	0.014	0.022	0.356	0.558	-
B1	0.045	0.070	1.15	1.77	8
C	0.008	0.014	0.204	0.355	-
D	0.735	0.775	18.66	19.68	5
D1	0.005	-	0.13	-	5
E	0.300	0.325	7.62	8.25	6
E1	0.240	0.280	6.10	7.11	5
e	0.100 BSC		2.54 BSC		-
e_A	0.300 BSC		7.62 BSC		6
e_B	-	0.430	-	10.92	7
L	0.115	0.150	2.93	3.81	4
N	14		14		9

Rev. 0 12/93

All Intersil U.S. products are manufactured, assembled and tested utilizing ISO9000 quality systems.
Intersil Corporation's quality certifications can be viewed at www.intersil.com/design/quality

Intersil products are sold by description only. Intersil Corporation reserves the right to make changes in circuit design, software and/or specifications at any time without notice. Accordingly, the reader is cautioned to verify that data sheets are current before placing orders. Information furnished by Intersil is believed to be accurate and reliable. However, no responsibility is assumed by Intersil or its subsidiaries for its use; nor for any infringements of patents or other rights of third parties which may result from its use. No license is granted by implication or otherwise under any patent or patent rights of Intersil or its subsidiaries.

For information regarding Intersil Corporation and its products, see www.intersil.com