

IRG4PSH71KPbF

INSULATED GATE BIPOLAR TRANSISTOR

Short Circuit Rated
UltraFast IGBT

Features

- Hole-less clip/pressure mount package compatible with TO-247 and TO-264, with reinforced pins
- High short circuit rating IGBTs, optimized for motorcontrol
- Minimum switching losses combined with low conduction losses
- Tightest parameter distribution
- Creepage distance increased to 5.35mm
- Lead-Free

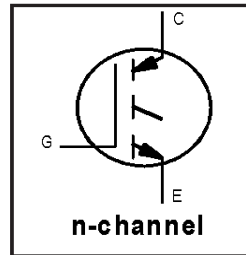

$V_{CES} = 1200V$
$V_{CE(on)} \text{ typ.} = 2.97V$
@ $V_{GE} = 15V, I_C = 42A$

Benefits

- Highest current rating IGBT
- Maximum power density, twice the power handling of the TO-247, less space than TO-264

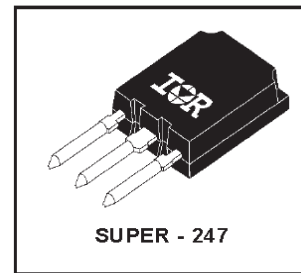

Absolute Maximum Ratings

	Parameter	Max.	Units
V_{CES}	Collector-to-Emitter Breakdown Voltage	1200	V
$I_C @ T_C = 25^\circ C$	Continuous Collector Current	78	A
$I_C @ T_C = 100^\circ C$	Continuous Collector Current	42	
I_{CM}	Pulsed Collector Current ①	156	
I_{LM}	Clamped Inductive Load Current ②	156	
t_{SC}	Short Circuit Withstand Time	10	μs
V_{GE}	Gate-to-Emitter Voltage	± 20	V
E_{ARV}	Reverse Voltage Avalanche Energy ③	170	mJ
$P_D @ T_C = 25^\circ C$	Maximum Power Dissipation	350	W
$P_D @ T_C = 100^\circ C$	Maximum Power Dissipation	140	
T_J	Operating Junction and	-55 to + 150	$^\circ C$
T_{STG}	Storage Temperature Range		
	Soldering Temperature, for 10 seconds	300 (0.063 in. (1.6mm from case)	

Thermal Resistance\ Mechanical

	Parameter	Min.	Typ.	Max.	Units
$R_{\theta JC}$	Junction-to-Case	---	---	0.36	$^\circ C/W$
$R_{\theta CS}$	Case-to-Sink, flat, greased surface	---	0.24	---	
$R_{\theta JA}$	Junction-to-Ambient, typical socket mount	---	---	38	
	Recommended Clip Force	20.0(2.0)	---	---	N (kgf)
	Weight	---	6 (0.21)	---	g (oz)

Electrical Characteristics @ T_J = 25°C (unless otherwise specified)

	Parameter	Min.	Typ.	Max.	Units	Conditions
V _{(BR)CES}	Collector-to-Emitter Breakdown Voltage	1200	—	—	V	V _{GE} = 0V, I _C = 250μA
V _{(BR)ECS}	Emitter-to-Collector Breakdown Voltage ④	18	—	—	V	V _{GE} = 0V, I _C = 1.0A
ΔV _{(BR)CES} /ΔT _J	Temperature Coeff. of Breakdown Voltage	—	1.1	—	V/°C	V _{GE} = 0V, I _C = 10mA
V _{CE(ON)}	Collector-to-Emitter Saturation Voltage	—	2.97	3.9	V	I _C = 42A V _{GE} = 15V
		—	3.44	—		I _C = 78A See Fig. 2, 5
		—	2.60	—		I _C = 42A, T _J = 150°C
V _{GE(th)}	Gate Threshold Voltage	3.0	—	6.0		V _{CE} = V _{GE} , I _C = 250μA
ΔV _{GE(th)} /ΔT _J	Temperature Coeff. of Threshold Voltage	—	-12	—	mV/°C	V _{CE} = V _{GE} , I _C = 1.5mA
g _{fe}	Forward Transconductance ⑤	25	38	—	S	V _{CE} = 50V, I _C = 42A
I _{CES}	Zero Gate Voltage Collector Current	—	—	500	μA	V _{GE} = 0V, V _{CE} = 1200V
		—	—	2.0		V _{GE} = 0V, V _{CE} = 10V, T _J = 25°C
		—	—	5.0	mA	V _{GE} = 0V, V _{CE} = 1200V, T _J = 150°C
I _{GES}	Gate-to-Emitter Leakage Current	—	—	±100	nA	V _{GE} = ±20V

Switching Characteristics @ T_J = 25°C (unless otherwise specified)

	Parameter	Min.	Typ.	Max.	Units	Conditions
Q _g	Total Gate Charge (turn-on)	—	410	610	nC	I _C = 42A
Q _{ge}	Gate - Emitter Charge (turn-on)	—	47	70		V _{CC} = 400V See Fig. 8
Q _{gc}	Gate - Collector Charge (turn-on)	—	145	220		V _{GE} = 15V
t _{d(on)}	Turn-On Delay Time	—	45	—	ns	T _J = 25°C I _C = 42A, V _{CC} = 960V V _{GE} = 15V, R _G = 5.0Ω
t _r	Rise Time	—	38	—		
t _{d(off)}	Turn-Off Delay Time	—	220	340		
t _f	Fall Time	—	160	250		
E _{on}	Turn-On Switching Loss	—	2.35	—	mJ	Energy losses include "tail" See Fig. 9,10,14
E _{off}	Turn-Off Switching Loss	—	3.14	—		
E _{ts}	Total Switching Loss	—	5.49	8.3		
t _{sc}	Short Circuit Withstand Time	10	—	—	μs	V _{CC} = 720V, T _J = 125°C V _{GE} = 20V, R _G = 5.0Ω
t _{d(on)}	Turn-On Delay Time	—	42	—	ns	T _J = 150°C I _C = 42A, V _{CC} = 960V V _{GE} = 15V, R _G = 5.0Ω
t _r	Rise Time	—	41	—		
t _{d(off)}	Turn-Off Delay Time	—	460	—		
t _f	Fall Time	—	250	—		
E _{ts}	Total Switching Loss	—	11.5	—	mJ	See Fig. 10,11,14
L _E	Internal Emitter Inductance	—	13	—	nH	Measured 5mm from package
C _{ies}	Input Capacitance	—	5770	—	pF	V _{GE} = 0V V _{CC} = 30V See Fig. 7 f = 1.0MHz
C _{oes}	Output Capacitance	—	400	—		
C _{res}	Reverse Transfer Capacitance	—	100	—		

Notes:

- ① Repetitive rating; V_{GE} = 20V, pulse width limited by max. junction temperature. (See fig. 13b)
- ② V_{CC} = 80%(V_{CES}), V_{GE} = 20V, L = 10μH, R_G = 5.0Ω, (See fig. 13a)
- ③ Repetitive rating; pulse width limited by maximum junction temperature

- ④ Pulse width ≤ 80μs; duty factor ≤ 0.1%
- ⑤ Pulse width 5.0μs, single shot

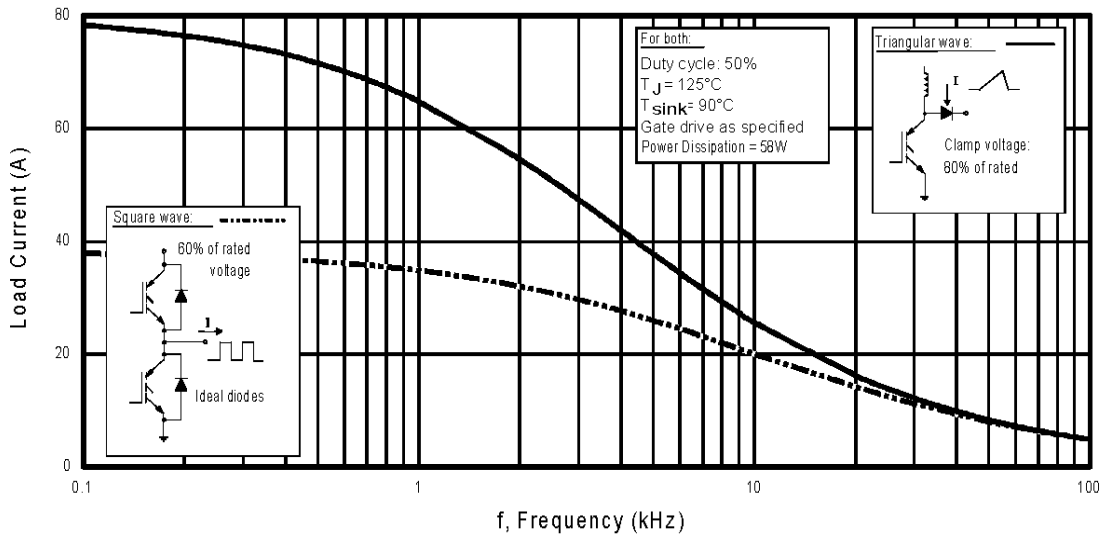

Fig. 1 - Typical Load Current vs. Frequency
(For square wave, $I = I_{RMS}$ of fundamental; for triangular wave, $I = I_{PK}$)

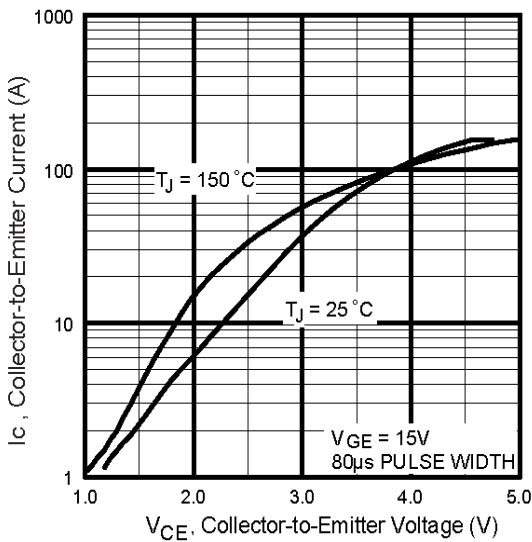

Fig. 2 - Typical Output Characteristics

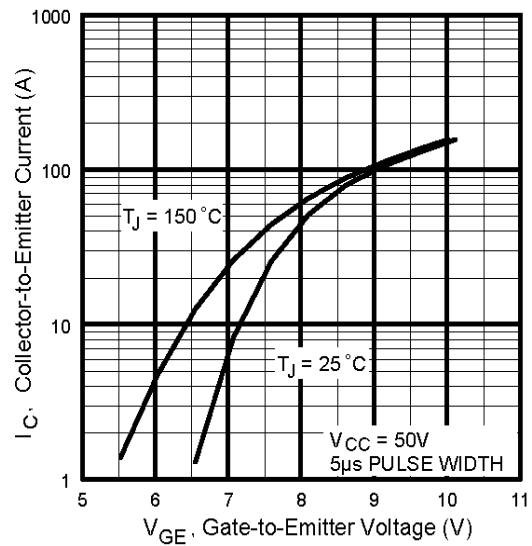

Fig. 3 - Typical Transfer Characteristics

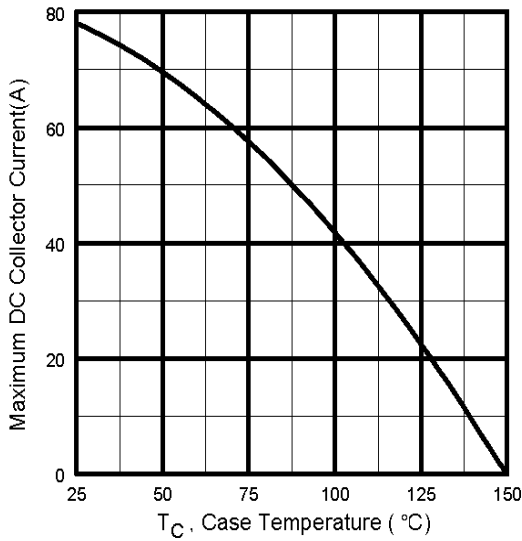

Fig. 4 - Maximum Collector Current vs. Case Temperature

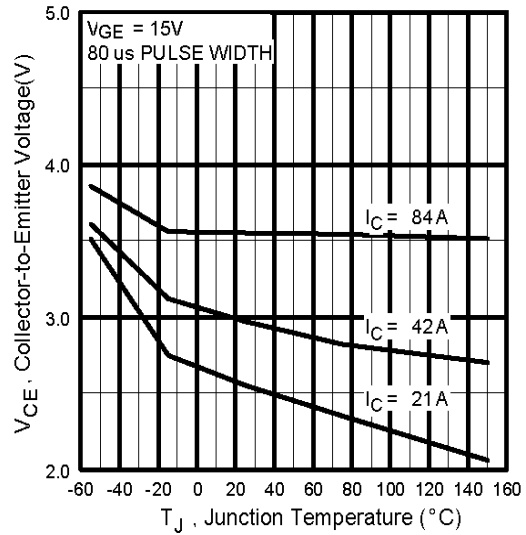

Fig. 5 - Collector-to-Emitter Voltage vs. Junction Temperature

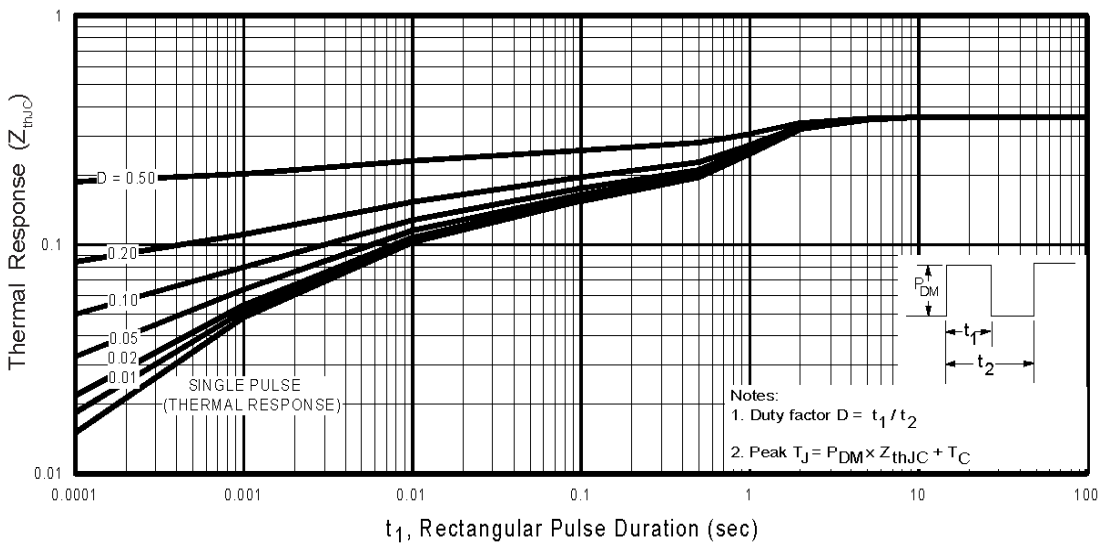

Fig. 6 - Maximum Effective Transient Thermal Impedance, Junction-to-Case

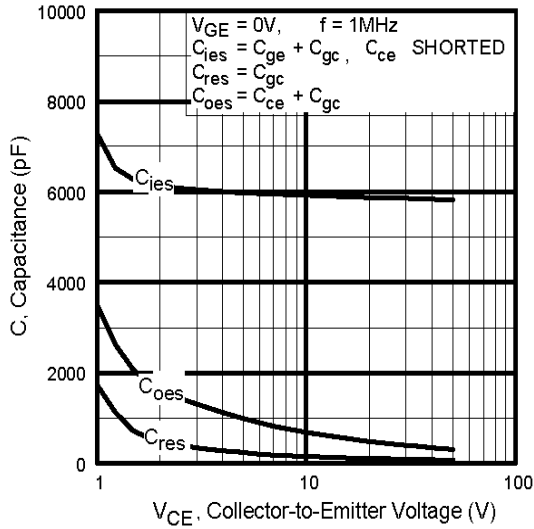

Fig. 7 - Typical Capacitance vs. Collector-to-Emitter Voltage

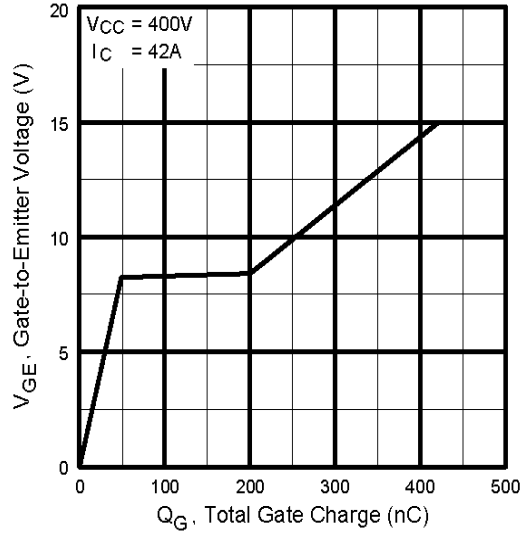

Fig. 8 - Typical Gate Charge vs. Gate-to-Emitter Voltage

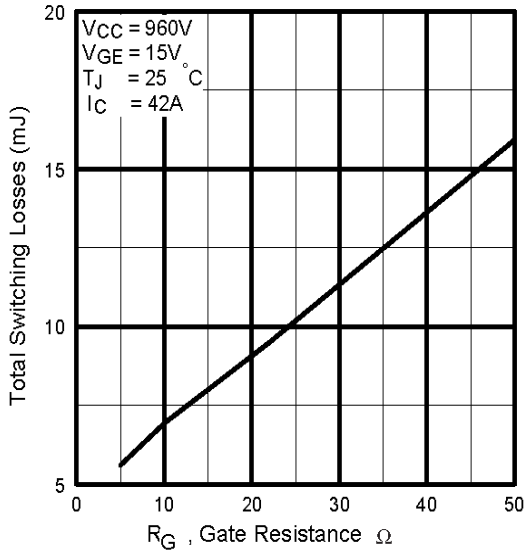

Fig. 9 - Typical Switching Losses vs. Gate Resistance

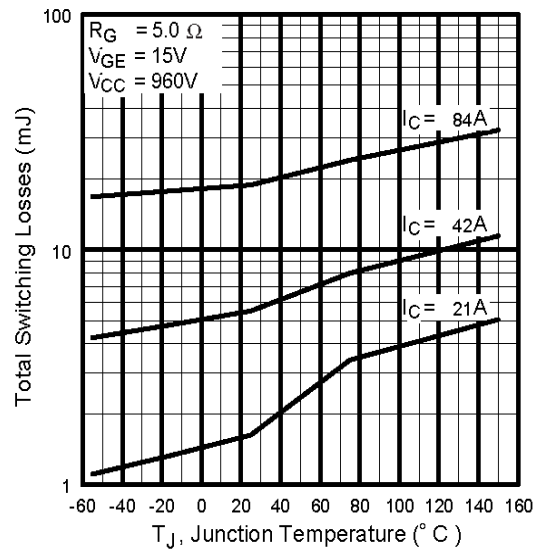

Fig. 10 - Typical Switching Losses vs. Junction Temperature

IRG4PSH71KPbF

International
IR Rectifier

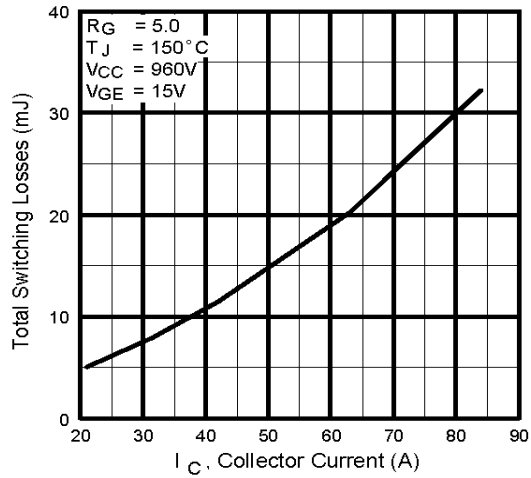

Fig. 11 - Typical Switching Losses vs. Collector-to-Emitter Current

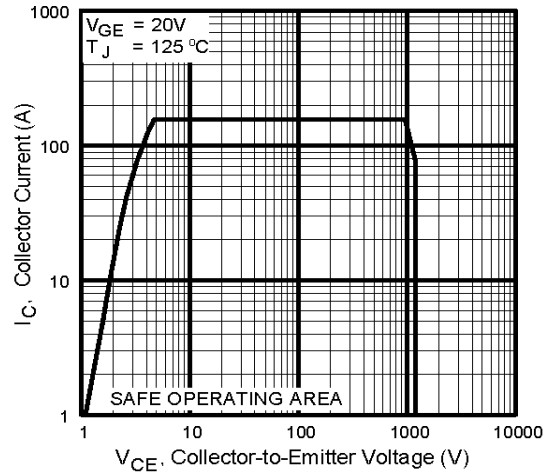
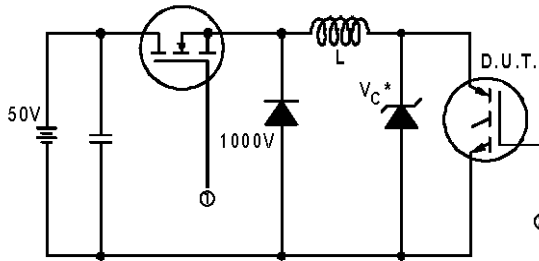

Fig. 12 - Turn-Off SOA



* Driver same type as D.U.T.; $V_c = 80\%$ of $V_{ce(max)}$
* Note: Due to the 50V power supply, pulse width and inductor will increase to obtain rated Id.

Fig. 13a - Clamped Inductive Load Test Circuit

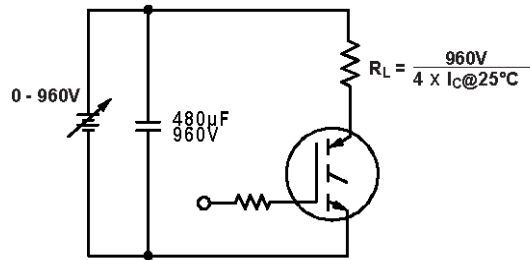

Fig. 13b - Pulsed Collector Current Test Circuit

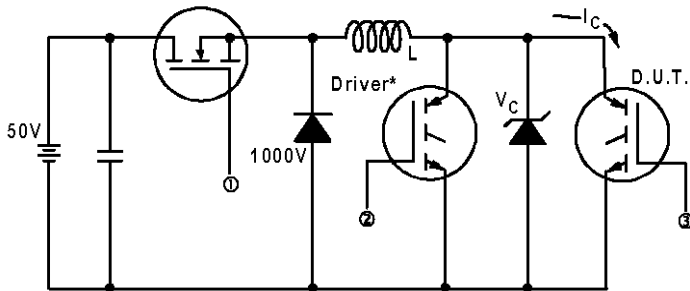

Fig. 14a - Switching Loss Test Circuit

* Driver same type as D.U.T., $V_C = 960V$

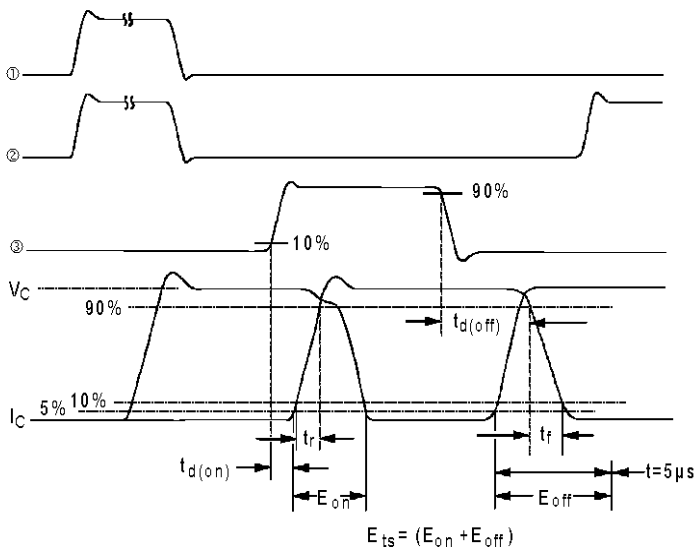
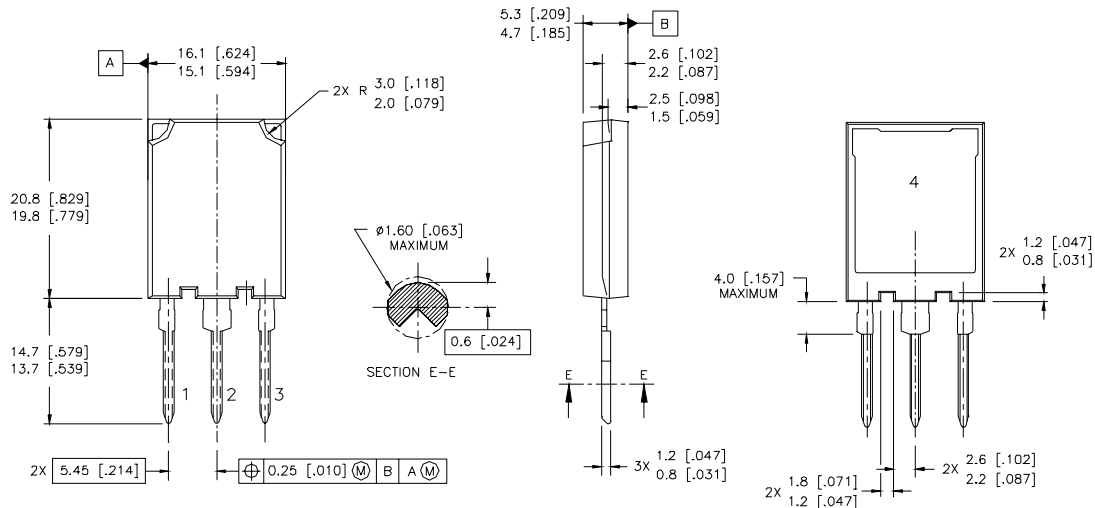

Fig. 14b - Switching Loss Waveforms

IRG4PSH71KPbF

International
IR Rectifier

Case Outline and Dimensions — Super-247



NOTES:

1. DIMENSIONS & TOLERANCING PER ASME Y14.5M-1994
2. CONTROLLING DIMENSION: MILLIMETER
3. DIMENSIONS ARE SHOWN IN MILLIMETRES [INCHES]

LEAD ASSIGNMENTS

MOSFET	IGBT
1 - GATE	1 - GATE
2 - DRAIN	2 - COLLECTOR
3 - SOURCE	3 - EMITTER
4 - DRAIN	4 - COLLECTOR

Super-247 (TO-274AA) Part Marking Information

EXAMPLE: THIS IS AN IRFPS37N50A WITH
ASSEMBLY LOT CODE 1789
ASSEMBLED ON WW 19, 1997
IN THE ASSEMBLY LINE "C"

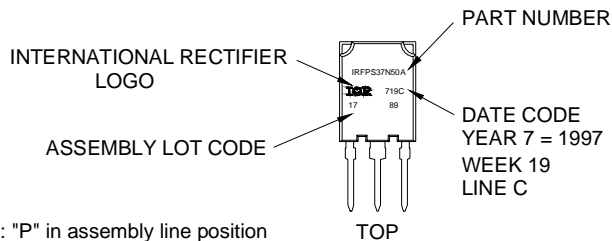

Note: "P" in assembly line position indicates "Lead-Free"

Data and specifications subject to change without notice.

International
IR Rectifier

IR WORLD HEADQUARTERS: 233 Kansas St., El Segundo, California 90245, USA Tel: (310) 252-7105
TAC Fax: (310) 252-7903

Visit us at www.irf.com for sales contact information. 09/04

www.irf.com