



The Future of Analog IC Technology®

# MP2101

## 1.6MHz Synchronous Step-Down plus 200mA LDO

### DESCRIPTION

The MP2101 is an internally compensated 1.6MHz fixed-frequency PWM step-down switcher with a 200mA low dropout (LDO) linear regulator. It is ideal for portable equipment powered by a single cell Lithium-Ion (Li+) Battery. The MP2101 can provide 800mA and 200mA of load current from a 2.5V to 6V input voltage. Both output voltages can be regulated as low as 0.6V.

The 800mA output channel features an integrated high-side switch and synchronous rectifier for high efficiency without an external Schottky diode. With peak current mode control and internal compensation, the MP2101 can be stabilized with ceramic capacitors and small inductors. The high-side switch can maintain 100% duty cycle in dropout condition.

The 200mA LDO output is used to power noise sensitive circuitry. It has a separate input supply to reduce power dissipation and noise from the main switcher. Dropout voltage is 280mV under a 150mA load. Fault condition protection includes cycle-by-cycle current limiting and thermal shutdown.

The MP2101 is available in small 3mm x 3mm 10-pin QFN packages.

### FEATURES

- 0.8A Switcher Output and 0.2A LDO Output
- $V_{IN1}$  Range for Switcher: 2.5V to 6V
- $V_{IN2}$  Range for LDO: 1.2V to  $V_{IN1}$
- Internal Power MOSFET Switches
- Stable with Low ESR Output Ceramic Capacitors
- Up to 93% Efficiency
- 0.01µA Shutdown Current
- 1.6MHz Fixed Switching Frequency
- Up to 100% Switcher Duty Cycle
- Thermal Shutdown
- Cycle-by-Cycle Over Current Protection
- Short Circuit Protection
- Power On Reset Output
- Available in 3x3 10-Pin QFN Packages

### APPLICATIONS

- DVD+/-RW Drives
- Smart Phones
- PDAs
- Digital Cameras
- Portable Instruments

"MPS" and "The Future of Analog IC Technology" are Registered Trademarks of Monolithic Power Systems, Inc.

### TYPICAL APPLICATION

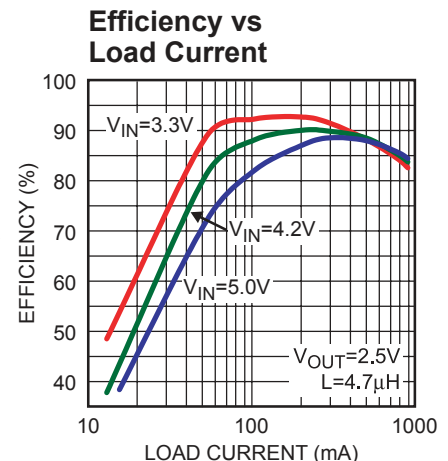
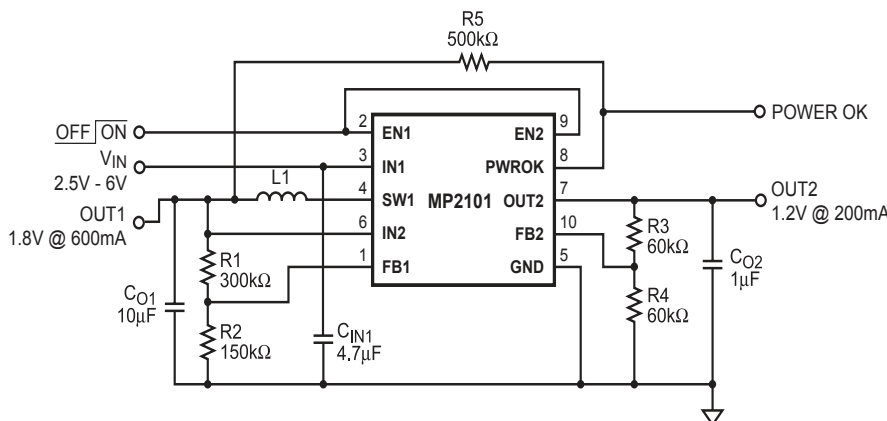

## PACKAGE REFERENCE

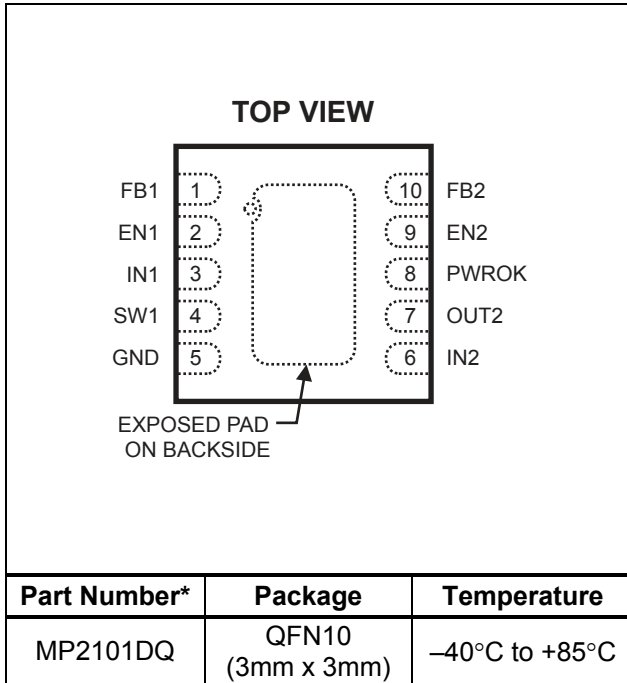

\* For Tape & Reel, add suffix -Z (eg. MP2101DQ-Z)  
 For RoHS compliant packaging, add suffix -LF (eg. MP2101DQ-LF-Z)

## ABSOLUTE MAXIMUM RATINGS <sup>(1)</sup>

IN1, OUT1/2 to GND ..... -0.3V to + 6.5V  
 IN2 to GND ..... -0.3V to  $V_{IN1} + 0.3V$   
 SW1 to GND ..... -0.3V to  $V_{IN1} + 0.3V$   
 PWROK to GND ..... -0.3V to +6.5V  
 FB1/2, EN1/2 to GND ..... -0.3V to +6.5V  
 Operating Temperature ..... -40°C to +85°C  
 Junction Temperature ..... 150°C  
 Lead Temperature ..... 260°C  
 Storage Temperature ..... -65°C to +150°C

## Recommended Operating Conditions <sup>(2)</sup>

Supply Voltage  $V_{IN1}$  ..... 2.5V to 6V  
 Supply Voltage  $V_{IN2}$  ..... 1.2V to  $V_{IN1}$   
 Output Voltage  $V_{OUT1/2}$  ..... 0.6V to 6V  
 Operating Temperature ..... -40°C to +85°C

**Thermal Resistance <sup>(3)</sup>**      $\theta_{JA}$       $\theta_{JC}$   
 QFN10 (3mm x 3mm) ..... 50 ..... 12... °C/W

### Notes:

- 1) Exceeding these ratings may damage the device.
- 2) The device is not guaranteed to function outside of its operating conditions.
- 3) Measured on approximately 1" square of 1 oz copper.

## ELECTRICAL CHARACTERISTICS <sup>(4)</sup>

$V_{IN1/2} = V_{EN1/2} = 3.6V$ ,  $T_A = +25^\circ C$ , unless otherwise noted.

Parameters	Condition	Min	Typ	Max	Units
No Load Supply Current	$V_{FB1/2} = 0.62V$		400	550	$\mu A$
	$V_{EN1} = 0V, V_{EN2} = 3.6V$		80	100	$\mu A$
	$V_{EN1} = 3.6V, V_{EN2} = 0V$		300	400	$\mu A$
Shutdown Current	$V_{EN1/2} = 0V, V_{IN1/2} = 6V$		0.01	1	$\mu A$
Thermal Shutdown Trip Threshold	Hysteresis = 20°C		150		°C
PWROK Upper-Trip Threshold	FB1/2 with respect to the Nominal Value		10		%
PWROK Lower-Trip Threshold	FB1/2 with respect to the Nominal Value		-10		%
PWROK Output Lower Voltage	$I_{SINK} = 5mA$			0.3	V
PWROK Deglitch Timer (FB1)	Switching Regulator		50		$\mu s$
PWROK Deglitch Timer (FB2)	LDO		150		
EN1/2 Trip Threshold	$-40^\circ C \leq T_A \leq +85^\circ C$	0.3	0.96	1.5	V
EN1/2 Pull-Down Resistor			900		k $\Omega$
<b>Switching Regulator</b>					
IN1 Under Voltage Lockout Threshold	Rising Edge	1.5	2.0	2.5	V
IN1 Under Voltage Lockout Hysteresis			100		mV
Regulated FB1 Voltage	$T_A = +25^\circ C$	0.588	0.600	0.612	V
	$-40^\circ C \leq T_A \leq +85^\circ C$	0.582		0.618	
FB1 Input Bias Current	$V_{FB1} = 0.62V$	-50	-2	+50	nA

**ELECTRICAL CHARACTERISTICS <sup>(4)</sup> (continued)**
 $V_{IN1/2} = V_{EN1/2} = 3.6V$ ,  $T_A = +25^\circ C$ , unless otherwise noted.

Parameters	Condition	Min	Typ	Max	Units
SW1 PFET On Resistance	$I_{SW1} = 100mA$		0.35		$\Omega$
SW1 NFET On Resistance	$I_{SW1} = -100mA$		0.25		$\Omega$
SW1 Leakage Current	$V_{EN1} = 0V$ , $V_{IN} = 6V$ $V_{SW1} = 0V$ or $6V$	-2		+2	$\mu A$
SW1 PFET Peak Current Limit	Duty Cycle = 100%, Current Pulse Width < 1ms	0.9	1.4	2.0	A
Oscillator Frequency		1.2	1.6	2.0	MHz
<b>Linear Regulator LDO</b>					
IN2 Input Range	$I_{LOAD} = 10mA$ , $V_{OUT2} = V_{FB2}$	1.2		$V_{IN1}$	V
Regulated FB2 Voltage	$T_A = +25^\circ C$	0.588	0.600	0.612	V
	$-40^\circ C \leq T_A \leq +85^\circ C$	0.582		0.618	
FB2 Input Bias Current	$V_{FB2} = 0.6V$	-50	-2	+50	nA
OUT2 Short Circuit Foldback	$V_{OUT2} = 0V$		180		mA
OUT2 Output Current	$V_{OUT} = 1.2V$	200			mA
Dropout Voltage <sup>(5)</sup>	$I_{LOAD} = 150mA$ , $V_{OUT2} = 1.2V$		280		mV

**Notes:**

- 4) Production test at  $+25^\circ C$ . Specifications over the temperature range are guaranteed by design and characterization.  
5) The dropout voltage is equal to  $V_{IN2} - V_{OUT2}$  when  $V_{OUT2}$  is 100mV below the nominal value.

**PIN FUNCTIONS**

Pin #	Name	Description
1	FB1	Feedback 1. Feedback Input for the switcher output (OUT1).
2	EN1	Enable 1. Enable input for the switcher. Pull high to turn on the switcher; low to turn it off.
3	IN1	Input 1. Main input supply for both the switcher and the auxiliary low dropout (LDO) linear regulator.
4	SW1	Switcher Switch Node. Output for the 800mA switcher channel.
5	GND	Ground.
6	IN2	Input 2. Input supply for the auxiliary linear regulator LDO output power device.
7	OUT2	Output 2. Output of the 200mA LDO. The LDO is designed to be stable with an external minimum 1 $\mu F$ ceramic capacitor at 200mA of load current.
8	PWROK	Power On Reset Open Drain Output. A high output indicates that both outputs are within $\pm 10\%$ of the regulation value. A low output indicates that the output is outside of the $\pm 10\%$ window. PWROK is pulled down if EN1 and/or EN2 is low. The PWROK window comparators have a 50 $\mu s$ deglitch timer for the switcher and 150 $\mu s$ deglitch timer for the linear regulator LDO to avoid a false trigger during load transient.
9	EN2	Enable 2. Enable input for the linear regulator LDO. Pull high to turn on the LDO; low to turn it off.
10	FB2	Feedback 2. Feedback input for the linear regulator output (OUT2).

## TYPICAL PERFORMANCE CHARACTERISTICS

$V_{IN} = 3.6V$ ,  $V_{OUT1} = 1.8V$ ,  $V_{OUT2} = 1.2V$ ,  $C_{IN1} = 4.7\mu F$ ,  $C_{IN2} = 1\mu F$ ,  $C_{O1} = 10\mu F$ ,  $C_{O2} = 1\mu F$ ,  $L = 2.2\mu H$ ,  
 $T_A = +25^\circ C$ , unless otherwise noted.

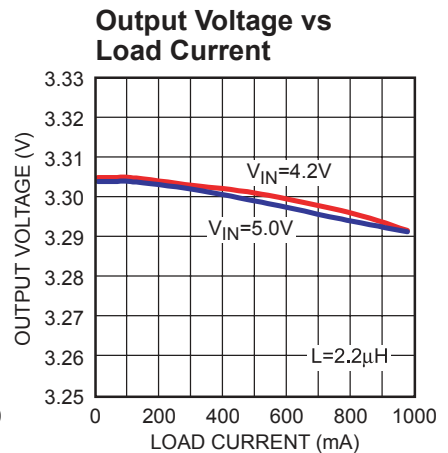
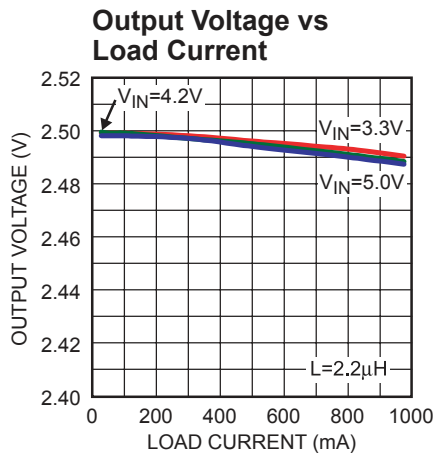
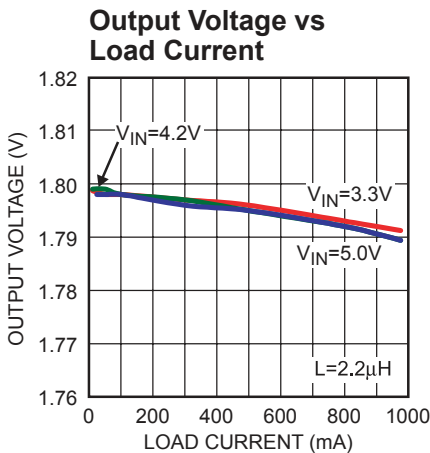
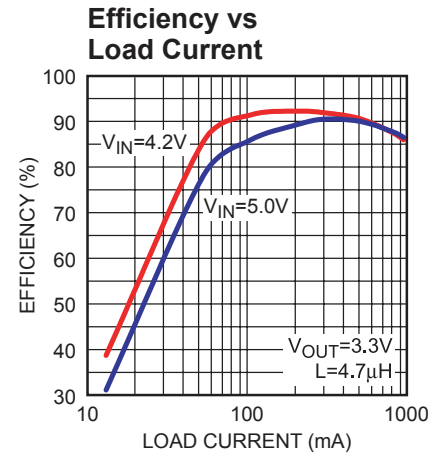
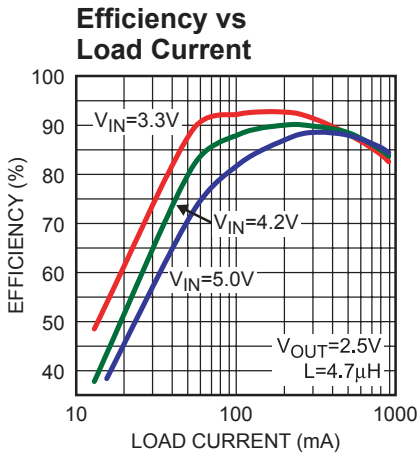
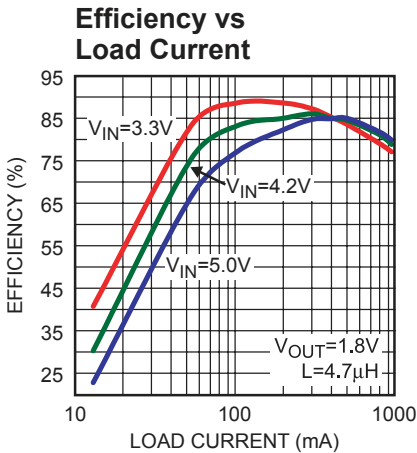
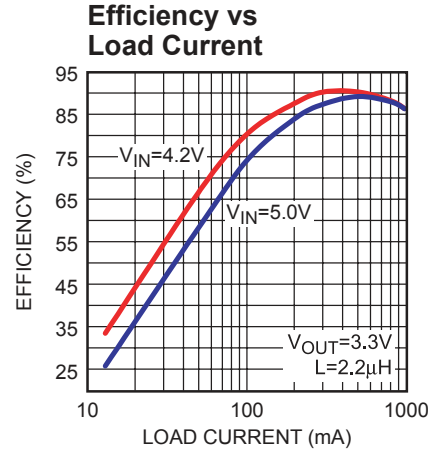
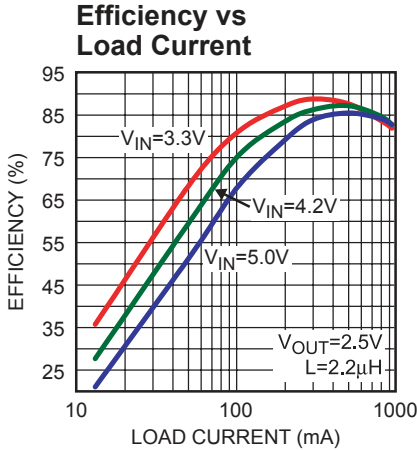
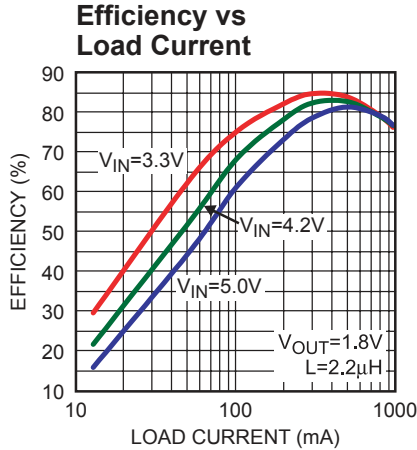

**TYPICAL PERFORMANCE CHARACTERISTICS (continued)**

$V_{IN} = 3.6V$ ,  $V_{OUT1} = 1.8V$ ,  $V_{OUT2} = 1.2V$ ,  $C_{IN1} = 4.7\mu F$ ,  $C_{IN2} = 1\mu F$ ,  $C_{O1} = 10\mu F$ ,  $C_{O2} = 1\mu F$ ,  $L = 2.2\mu H$ ,  
 $T_A = +25^\circ C$ , unless otherwise noted.

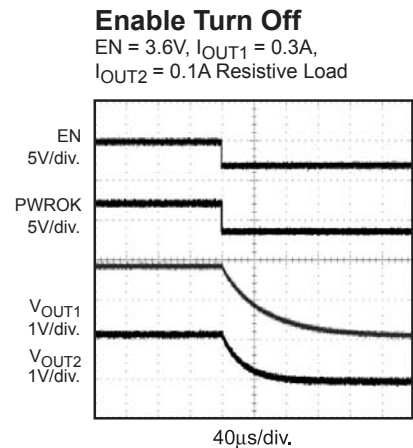
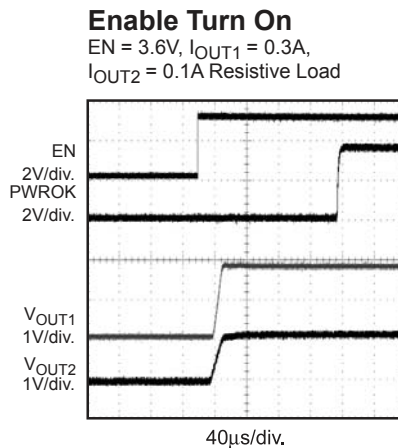
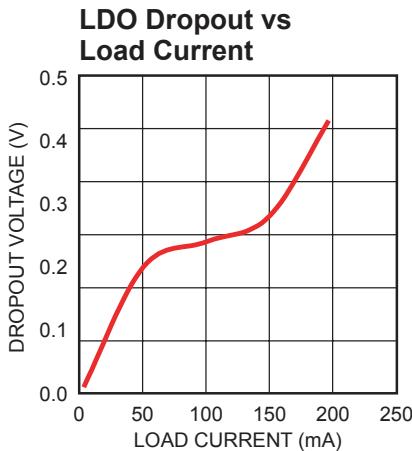
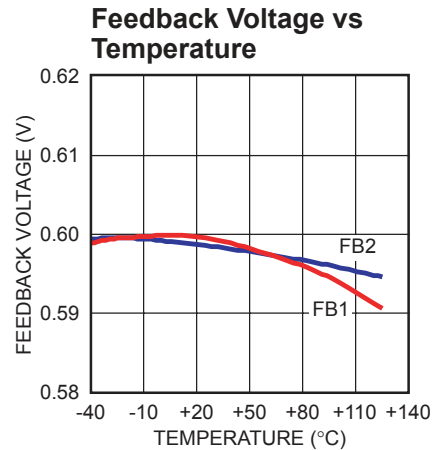
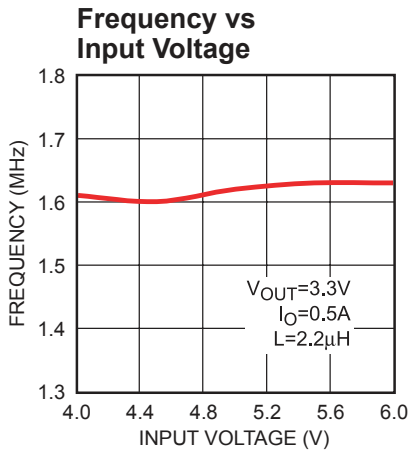
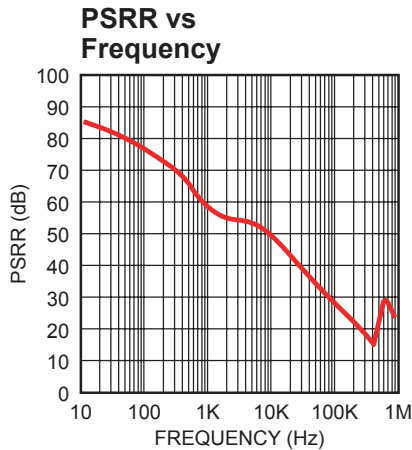
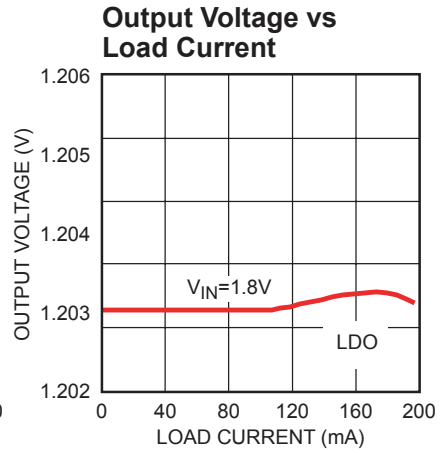
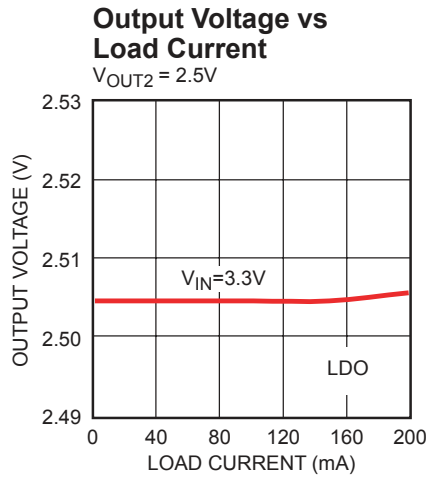
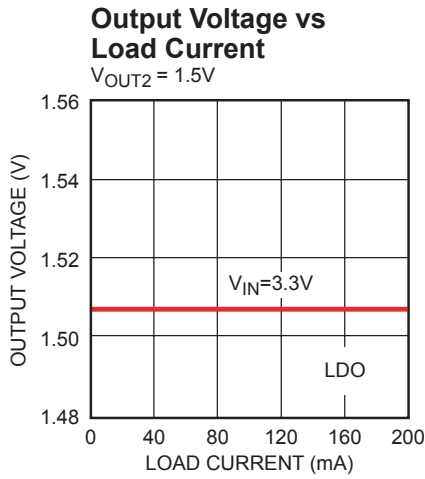

**TYPICAL PERFORMANCE CHARACTERISTICS (continued)**

$V_{IN} = 3.6V$ ,  $V_{OUT1} = 1.8V$ ,  $V_{OUT2} = 1.2V$ ,  $C_{IN1} = 4.7 \mu F$ ,  $C_{IN2} = 1 \mu F$ ,  $C_{O1} = 10 \mu F$ ,  $C_{O2} = 1 \mu F$ ,  $L = 2.2 \mu H$ ,  $T_A = +25^\circ C$ , unless otherwise noted.

**Input Ramp Up**

$EN = 4V$ ,  $I_{OUT1} = 0.3A$ ,  
 $I_{OUT2} = 0.1A$  Resistive Load

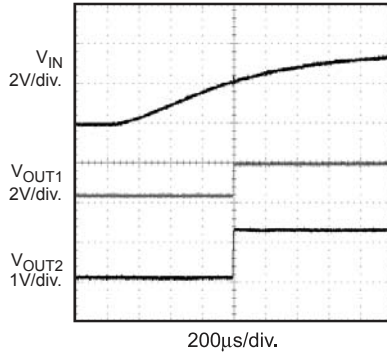
**Input Ramp Down**

$EN = 4V$ ,  $I_{OUT1} = 0.3A$ ,  
 $I_{OUT2} = 0.1A$  Resistive Load

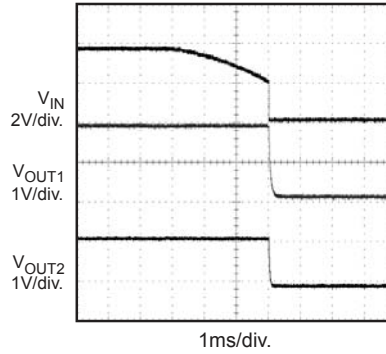
**Heavy Load Ripple**

$EN1 = V_{IN} = 5V$ ,  
 $I_{OUT1} = 0.8A$  Resistive Load

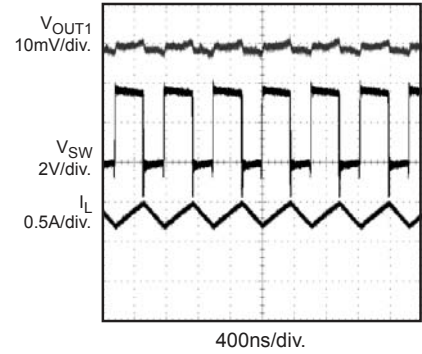
**PWROK Off vs VOUT1 Shorted**

$EN = 4V$ ,  $I_{OUT1} = 0.3A$ ,  
 $I_{OUT2} = 0.1A$  Resistive Load

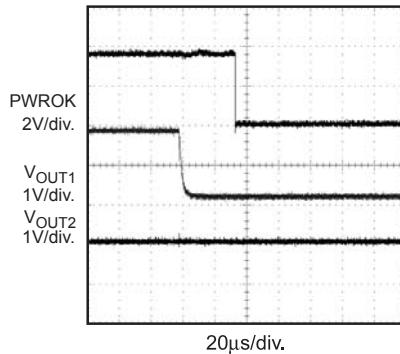
**PWROK Off vs VOUT2 Shorted**

$EN = 4V$ ,  $I_{OUT1} = 0.3A$ ,  
 $I_{OUT2} = 0.1A$  Resistive Load

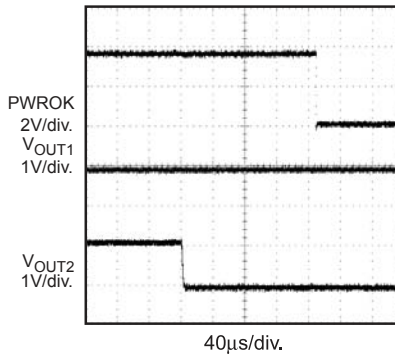
**Over Current Protection**

$I_{OUT1} = 0.3A$  Resistive Load

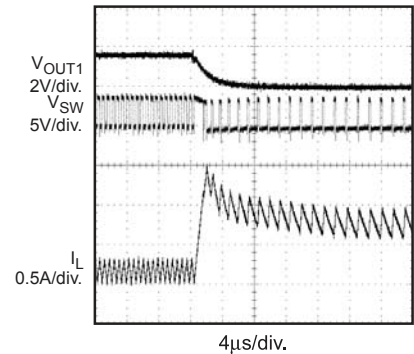
**Switcher Load Transient**

$I_{OUT1} = 0.8A$  Resistive Load

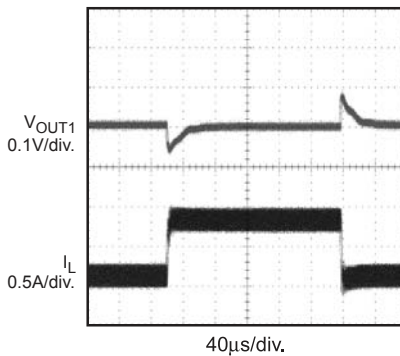
**LDO Load Transients**

$V_{IN2} = 3.3V$ ,  $V_{OUT2} = 1.2V$ ,  
 $I_{OUT2} = 0.02A$  to  $0.15A$  Resistive Load

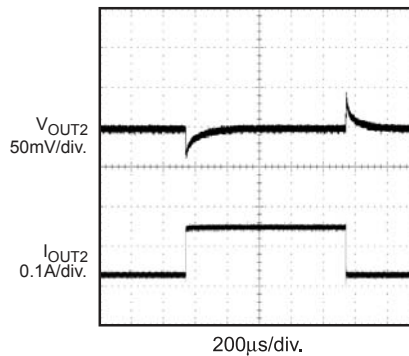
**LDO Over Current Protection**

$V_{IN2} = 3.3V$ ,  $V_{OUT2} = 2.5V$

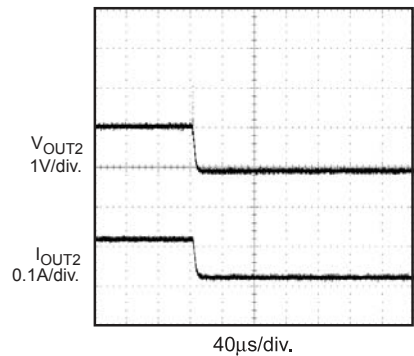

## OPERATION

The MP2101 is a fixed-frequency 1.6MHz, 800mA current mode PWM step-down switcher with a 200mA low dropout (LDO) linear regulator. The MP2101 is optimized for low voltage, Li-Ion battery powered applications where high efficiency and small size are critical.

The MP2101 uses an external resistor divider to set both the switcher and LDO output voltage from 0.6V to 6V.

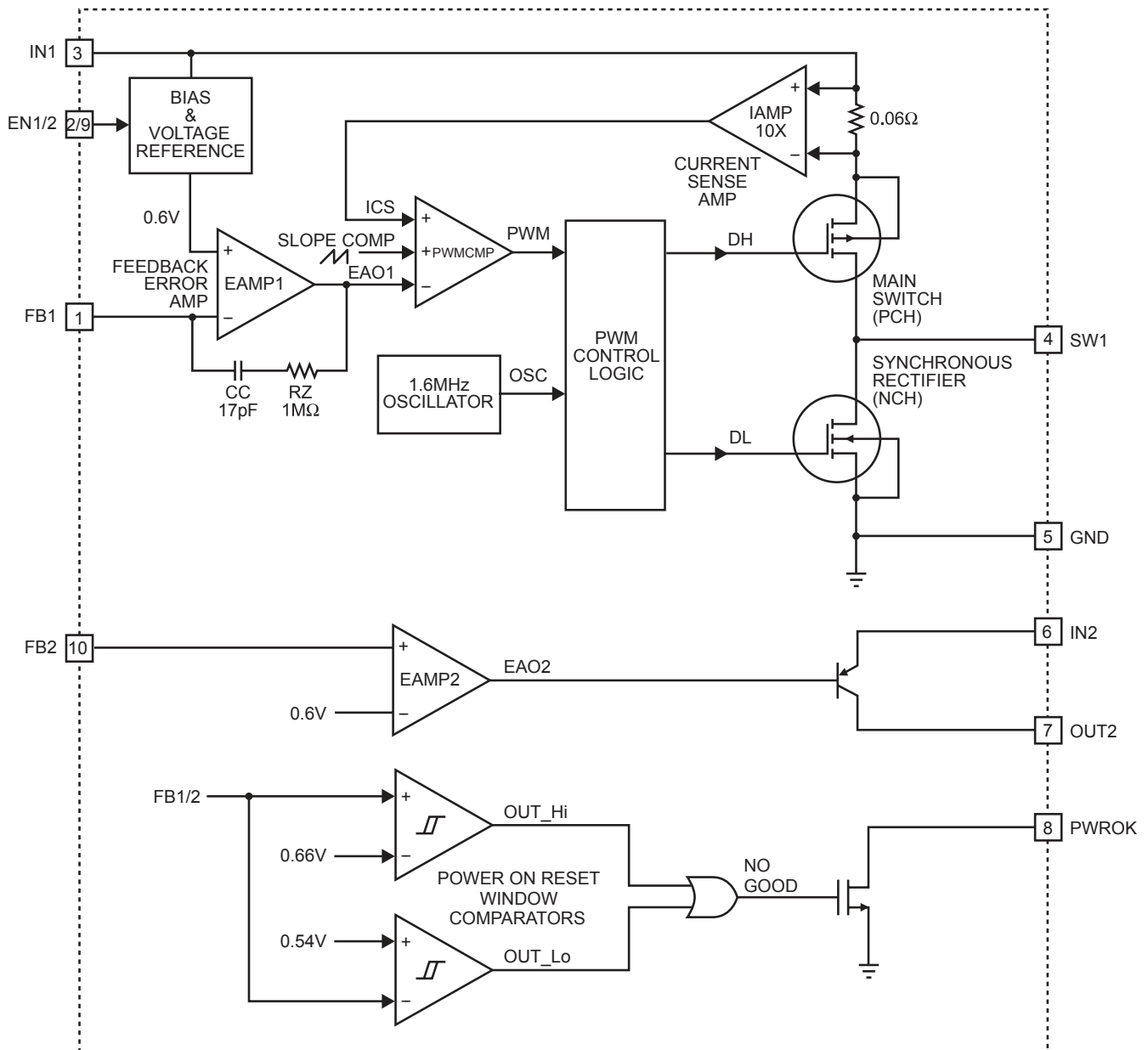

**Figure 1—MP2101 Function Diagram**

### 800mA Step-Down Switcher

The switcher integrates both a main switch and a synchronous rectifier, which provides high efficiency and eliminates the need for an external Schottky diode.

This switcher can achieve 100% duty cycle. The duty cycle (D) of a step-down switcher is defined as:

$$D = T_{ON} \times f_{OSC} \times 100\% \approx \frac{V_{OUT}}{V_{IN}} \times 100\%$$

Where  $T_{ON}$  is the main switch on time and  $f_{OSC}$  is the oscillator frequency (1.6MHz).

### Current Mode PWM Control

Slope compensated current mode PWM control provides stable switching and cycle-by-cycle current limiting for superior load and line response in addition to protection of the internal main switch and synchronous rectifier. During each cycle, the PWM comparator modulates the power transferred to the load by changing the inductor peak current based on the feedback error voltage. During normal operation, the main switch is turned on to ramp the inductor current at each rising edge of the internal oscillator, then switched off when the peak inductor current is above the error voltage. When the main switch is turned off, the synchronous rectifier is immediately turned on and stays on until the next cycle begins.

### Dropout Operation

The MP2101 allows the main switch to remain on for more than one switching cycle and increases the duty cycle while the input voltage is dropping close to the output voltage. When the duty cycle reaches 100%, the main switch is held on to deliver current to the output up to the PFET current limit. The output voltage then becomes the input voltage minus the voltage drop across the main switch and the inductor.

### Short Circuit Protection

When the output is shorted to ground, the oscillator frequency is reduced to prevent the inductor current from increasing beyond the PFET current limit, which is also reduced to lower the short circuit current. The frequency and current limit will return to the normal values once the short circuit condition is removed and the feedback voltage reaches 0.6V.

### Maximum Load Current

The MP2101 can operate down to a 2.5V input voltage. However the maximum load current decreases at lower inputs due to a large IR drop on the main switch and synchronous rectifier. The slope compensation signal reduces the peak inductor current as a function of the duty cycle to prevent sub-harmonic oscillations at duty cycles greater than 50%. Conversely, the current limit increases as the duty cycle decreases.

### Power OK

The MP2101 provides an open-drain PWROK output that goes high after both channels reach regulation during startup. PWROK goes low after one of the output channels goes out of regulation by  $\pm 10\%$  or when the device enters shutdown. There is a built-in deglitch timer to avoid a false PWROK trigger during load transients (50 $\mu$ s for the switcher and 150 $\mu$ s for the LDO). When the output is disabled, Power OK remains low.

### 200mA Linear Regulator

The 200mA low dropout (LDO) linear regulator has separate input (IN2) and output (OUT2) pins for the internal power device. The control circuitry of the LDO takes power from the main input supply (IN1). Both IN1 and IN2 input supplies must be present for the LDO to work properly. The LDO power device input (IN2) can be connected to the switcher output or directly to the main supply (Figure 2). If IN2 is tied to IN1, an optional RC filter can be inserted between IN1 and IN2. The RC filter reduces switching noise coupling from IN1 to IN2 and power dissipation inside the MP2101. The switcher guarantees 800mA output current, but output current to the switcher load will be reduced if the LDO draws current from the switcher output.



## APPLICATION INFORMATION

### Output Voltage Setting

The external resistor divider sets the output voltage. The feedback resistor R1 of the switcher also sets the feedback loop bandwidth with the internal compensation capacitor (see Figure 1).

R1 of the switcher should be 300kΩ for optimal transient response. R2 is then given by:

$$R2 = \frac{R1}{\frac{V_{OUT1}}{0.6V} - 1}$$

R4 of the LDO should be 60kΩ for good loop response. R3 is then given by:

$$R3 = R4 \times \left( \frac{V_{OUT2}}{0.6V} - 1 \right)$$

**Table 1—Resistor Selection vs. Output Voltage Setting**

V <sub>OUT</sub>	R1	R2	R3	R4
1.2V	300kΩ (1%)	300kΩ (1%)	60kΩ (1%)	60kΩ (1%)
1.5V	300kΩ (1%)	200kΩ (1%)	90kΩ (1%)	60kΩ (1%)
1.8V	300kΩ (1%)	150kΩ (1%)	120kΩ (1%)	60kΩ (1%)
2.5V	300kΩ (1%)	95.3kΩ (1%)	190kΩ (1%)	60kΩ (1%)

### Inductor Selection

A 1μH to 10μH inductor with a DC current rating of at least 25% higher than the maximum load current is recommended for most applications. For best efficiency, the inductor DC resistance should be <200mΩ. See Table 2 for recommended inductors and manufacturers. For most designs, the inductance value can be derived from the following equation:

$$L = \frac{V_{OUT} \times (V_{IN} - V_{OUT})}{V_{IN} \times \Delta I_L \times f_{OSC}}$$

Where ΔI<sub>L</sub> is inductor ripple current.

Choose the inductor ripple current to be approximately 30% of the maximum load current (800mA).

The maximum inductor peak current is:

$$I_{L(MAX)} = I_{LOAD} + \frac{\Delta I_L}{2}$$

Under light load conditions below 100mA, larger inductance is recommended for improved efficiency. Table 3 lists inductors recommended for this purpose.

**Table 2—Suggested Surface Mount Inductors**

Manufacturer	Part Number	Inductance (μH)	Max DCR (Ω)	Saturation Current (A)	Dimensions LxWxH (mm <sup>3</sup> )
Sumida	CDRH2D11	2.2	0.098	1.27	3.2 x 3.2 x 1.2
Toko	D521C	2.2	0.059	1.63	5 x 5 x 1.5
Sumida	CDRH3D16	2.2	0.072	1.20	4 x 4 x 1.8

**Table 3—Inductors for Improved Efficiency at 25mA, 50mA, under 100mA Load.**

Manufacturer	Part Number	Inductance (μH)	Max DCR (Ω)	Saturation Current (A)	I <sub>RMS</sub> (A)
Coilcraft	DO1605T-103MX	10	0.3	1.0	0.9
Murata	LQH4C100K04	10	0.2	1.2	0.8
Sumida	CR32-100	10	0.2	1.0	0.7
Sumida	CR54-100	10	0.1	1.2	1.4

### Switcher Input Capacitor Selection

The input capacitor ( $C_{IN1}$ ) reduces the surge current drawn from the input and switching noise from the device. The input capacitor impedance at the switching frequency should be less than the input source impedance to prevent high frequency switching current passing to the input. Ceramic capacitors with X5R or X7R dielectrics are highly recommended because of their low ESR and small temperature coefficients. For most applications, a 4.7 $\mu$ F capacitor is sufficient.

### Switcher Output Capacitor Selection

The output capacitor ( $C_{O1}$ ) keeps the output voltage ripple small and ensures regulation loop stability. The output capacitor impedance should be low at the switching frequency. Ceramic capacitors with X5R or X7R dielectrics are recommended. The output ripple  $\Delta V_{OUT}$  is approximately:

$$\Delta V_{OUT1} \leq \frac{V_{OUT1} \times (V_{IN1} - V_{OUT1})}{V_{IN1} \times f_{OSC} \times L} \times \left( ESR + \frac{1}{8 \times f_{OSC} \times C_{O1}} \right)$$

### Thermal Dissipation

Power dissipation should be considered when both channels of the MP2101 provide maximum output current at high ambient temperatures. If the junction temperature rises above 150°C, the two channels will shut down.

The junction-to-ambient thermal resistance of the 10-pin QFN (3mm x 3mm)  $R_{\theta JA}$  is 50°C/W. The maximum power dissipation is about 1.6W when the MP2101 is operating in a 70°C ambient temperature environment.

$$PD_{MAX} = \frac{150^{\circ}C - 70^{\circ}C}{50^{\circ}C/W} = 1.6W$$

### Start-Up Consideration

To ensure a smooth start-up of OUT1 and OUT2, it is recommended that the enable signals (EN1 and EN2) be asserted only after the input power rails have been stabilized. If EN1 and EN2 are tied to input rails directly, the UVLO of the MP2101 will dictate when the part starts switching. Since for certain systems, the input supply may have relatively high impedance during ramp up, therefore depending solely on UVLO to start the part may cause input rail dip and output bounce. If the system designer can not provide the enable signal after input power rail is fully established, it is recommended that EN1 and EN2 are connected to the input power rail through a RC delay network (as shown in Figure 2). The RC time constant needs to be significantly large compare to the ramp-up time of the input power rail, which is usually of a few ms.

### PC Board Layout

The high current paths (GND, IN1/IN2 and SW1) should be placed very close to the device with short, direct and wide traces. Input capacitors should be placed as close as possible to the respective IN and GND pins. The external feedback resistors should be placed next to the FB pins. Keep the switching nodes SW1 short and away from the feedback network.

TYPICAL APPLICATION CIRCUIT

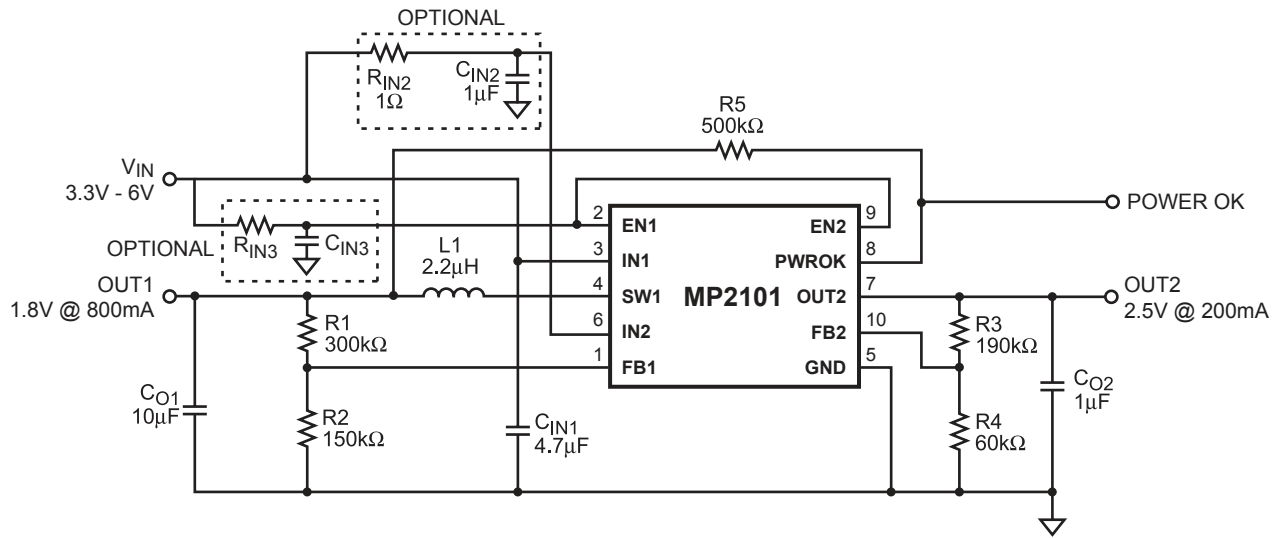
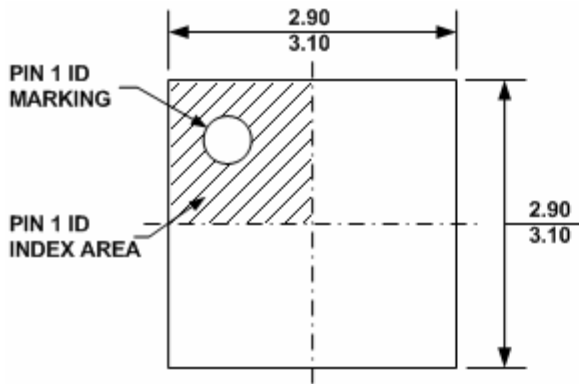
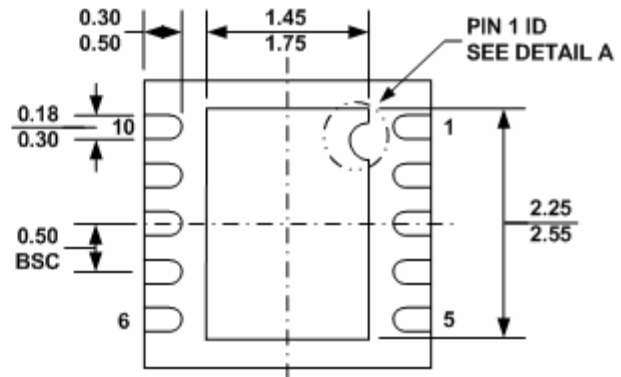
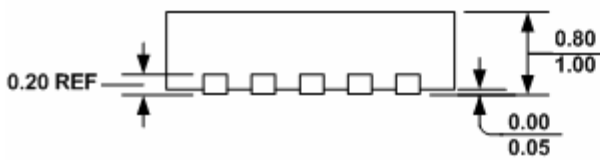
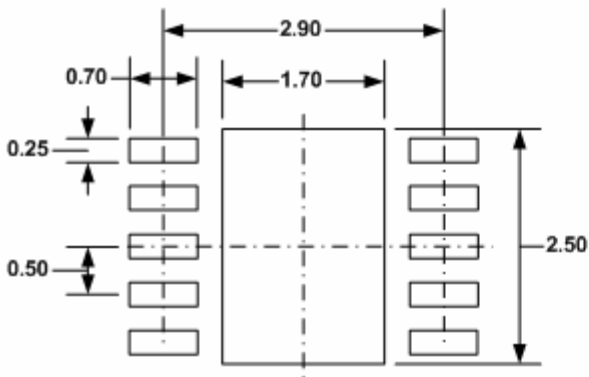

Figure 2—Optional RC Delay on EN1 and EN2 Circuit

**PACKAGE INFORMATION****3mm x 3mm QFN10****TOP VIEW****BOTTOM VIEW****SIDE VIEW****PIN 1 ID OPTION A  
R0.20 TYP.****PIN 1 ID OPTION B  
R0.20 TYP.****DETAIL A****RECOMMENDED LAND PATTERN****NOTE:**

- 1) ALL DIMENSIONS ARE IN MILLIMETERS.
- 2) EXPOSED PADDLE SIZE DOES NOT INCLUDE MOLD FLASH.
- 3) LEAD COPLANARITY SHALL BE 0.10 MILLIMETER MAX.
- 4) DRAWING CONFORMS TO JEDEC MO-229, VARIATION VEED-5.
- 5) DRAWING IS NOT TO SCALE.

**NOTICE:** The information in this document is subject to change without notice. Users should warrant and guarantee that third party Intellectual Property rights are not infringed upon when integrating MPS products into any application. MPS will not assume any legal responsibility for any said applications.