

# HIGH-SPEED EDGE CARD SYSTEMS

0.60 mm, 0.80 mm and 1.00 mm PITCH

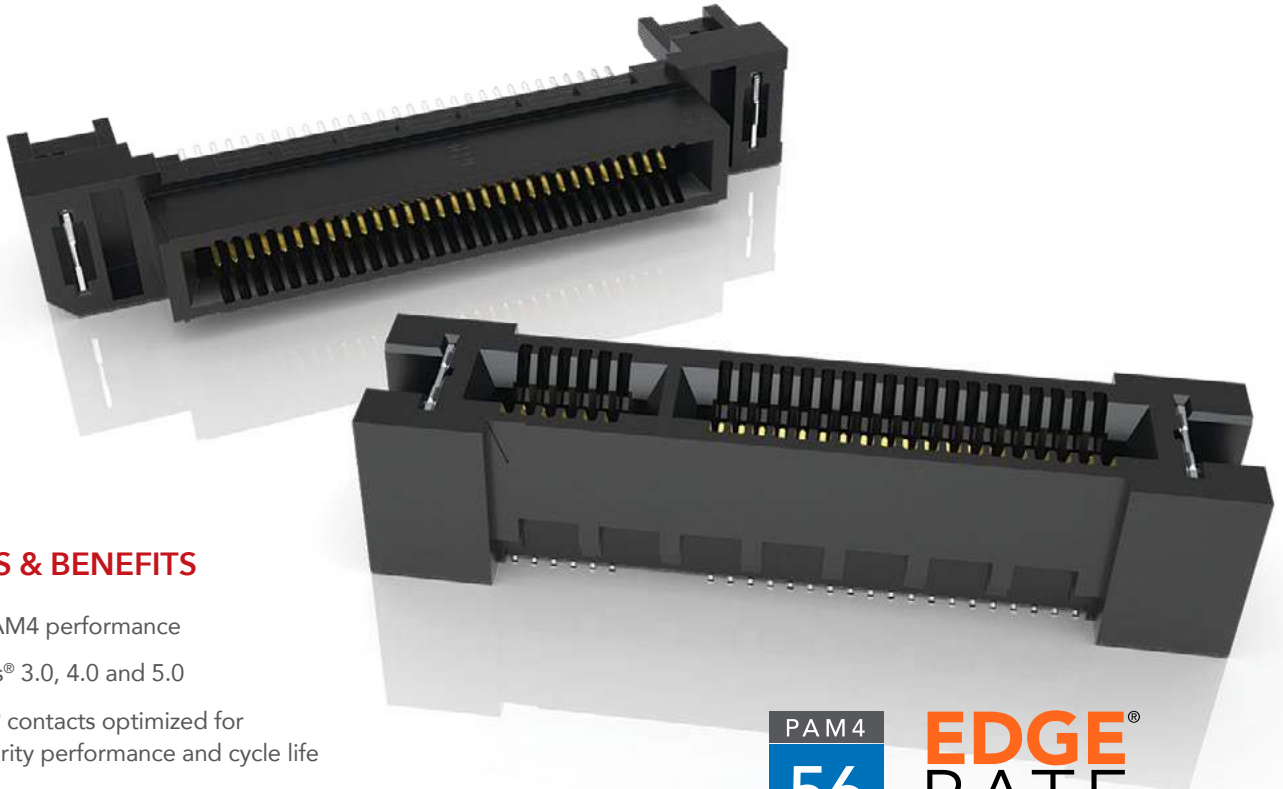

## FEATURES & BENEFITS

- 56 Gbps PAM4 performance
- PCI Express® 3.0, 4.0 and 5.0
- Edge Rate® contacts optimized for signal integrity performance and cycle life
- Up to 200 positions available
- Vertical, right-angle, edge mount, pass-through orientations
- Power/signal combo, press-fit tails, rugged weld tabs, locks and latches
- Mating cable assemblies available

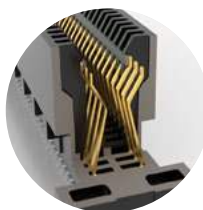
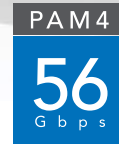

Rugged tucked beam technology (HTEC8)



Differential pair for increased speed (HSEC8-DP)

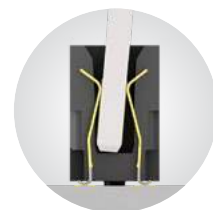

Custom designs allow for misalignment in the X-Y axes (HSEC1)

## KEY SPECIFICATIONS

SERIES	PITCH	TOTAL POSITIONS	INSULATOR MATERIAL	CONTACT MATERIAL	OPERATING TEMP RANGE	CURRENT RATING	VOLTAGE RATING	LEAD-FREE SOLDERABLE
HSEC6	0.60 mm	56-168	Black LCP	Copper Alloy	-55 °C to +125 °C	0.8 A (12 pins)	300 VAC	Yes
HTEC8	0.80 mm	40-200	Black LCP	Copper Alloy	-55 °C to +125 °C	3.0 A (2 pins)	215 VAC	Yes
HSEC8	0.80 mm	18-200	Black LCP	BeCu	-55 °C to +125 °C	2.8 A (2 pins)	240 VAC	Yes
HSEC1	1.00 mm	20-140	Black LCP	Phosphor Bronze	-55 °C to +125 °C	2.2 A (2 pins)	215 VAC	Yes

**(0.80 mm) .0315" PITCH • PASS-THROUGH & POWER COMBO**

<b>HSEC8</b>	<b>1</b>	<b>POSITIONS PER ROW</b>	<b>CARD THICKNESS</b>	<b>PLATING OPTION</b>	<b>DV</b>	<b>A</b>	<b>PE</b>	<b>OTHER OPTIONS</b>
--------------	----------	--------------------------	-----------------------	-----------------------	-----------	----------	-----------	----------------------

**10, 13, 20**

**-01**  
= (1.60 mm) .062" thick card

**-L**  
= 10 μ" (0.25 μm)  
Gold on contact area, Matte Tin on tail

**-S**  
= 30 μ" (0.76 μm)  
Gold on contact area, Matte Tin on tail

**-K**  
= (5.50 mm) .217" DIA  
Polyimide Film Pick & Place Pad

**-TR**  
=Tape & Reel Packaging

**-FR**  
= Full Reel Tape & Reel Packaging (Must order max. quantities per reel. Contact Samtec for parts per reel)

**HSEC8-PE**

**Card Mates:**  
(1.60 mm) .062" thick card, HSC8

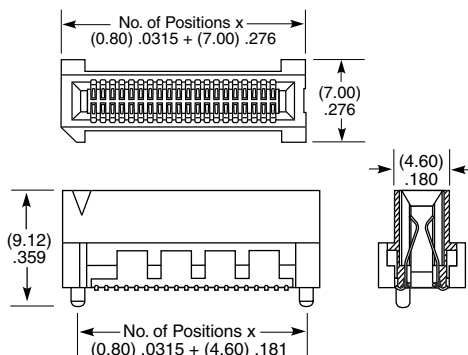

View complete specifications at: [samtec.com?HSEC8-DV](http://samtec.com?HSEC8-DV)

<b>HSEC8</b>	<b>1</b>	<b>SIGNAL POSITIONS</b>	<b>CARD THICKNESS</b>	<b>PLATING OPTION</b>	<b>PV</b>	<b>POWER POSITIONS</b>	<b>POWER TAIL</b>	<b>OTHER OPTION</b>
--------------	----------	-------------------------	-----------------------	-----------------------	-----------	------------------------	-------------------	---------------------

**20, 30, 40**  
(Signal positions per row)

**-01**  
= (1.60 mm) .062" thick card

**-L**  
= 10 μ" (0.25 μm)  
Gold on contact area, Matte Tin on tail

**-S**  
= 30 μ" (0.76 μm)  
Gold on contact area, Matte Tin on tail

**-2, -4**  
(Total, 2 per power bank)

**-1**  
= Use with (1.60 mm) .062" Thick PCB

**-2**  
= Use with (2.36 mm) .093" Thick PCB

**-WT**  
= Weld Tab

**HSEC8-PV**

**Card Mates:**  
(1.60 mm) .062" thick card

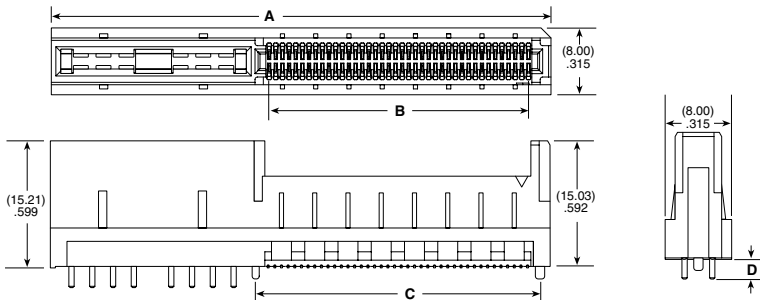
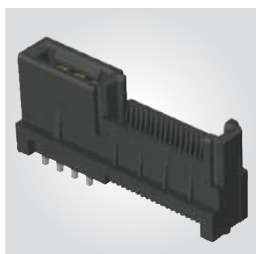

SIGNAL POSITIONS	POWER POSITIONS						POWER TAIL	D
	A (-2)	B (-2)	C (-2)	A (-4)	B (-4)	C (-4)		
20	(32.10) 1.264	(15.20) .598	(18.20) .717	(44.10) 1.736	(15.20) .598	(18.20) .717	-1	(2.35) .093
30	(40.10) 1.579	(23.20) .913	(26.20) 1.031	(52.10) 2.051	(23.20) .913	(26.20) 1.031	-2	(3.13) .123
40	(48.10) 1.894	(31.20) 1.228	(34.20) 1.346	(60.10) 2.366	(31.20) 1.228	(34.20) 1.346		

**Note:**  
Some sizes, styles and options are non-standard, non-returnable.

View complete specifications at: [samtec.com?HSEC8-PV](http://samtec.com?HSEC8-PV)