

Evaluating the ADAQ4001/ADAQ4003 16-/18-Bit, 2 MSPS, μ Module Data Acquisition Solution**FEATURES**

- ▶ Fully featured Pmod evaluation board with a Pmod to FMC interposer board
- ▶ Versatile analog signal conditioning circuitry
- ▶ On-board reference and ADC drivers
- ▶ PC software for control and data analysis of time and frequency domain
- ▶ System demonstration platform compatible ([EVAL-SDP-CH1Z](#))

EVALUATION BOARD KIT CONTENTS

- ▶ [EVAL-ADAQ4001PMDZ](#) or [EVAL-ADAQ4003PMDZ](#) Pmod evaluation board
- ▶ EVAL-PMD-IB1Z Pmod to FMC interposer board

EQUIPMENT NEEDED

- ▶ PC running Windows® 10 or higher
- ▶ EVAL-SDP-CH1Z ([SDP-H1](#)) controller board
- ▶ Precision signal source
- ▶ Cable (SMB input to evaluation board)
- ▶ Standard USB A to Mini-B USB cable
- ▶ Band-pass filter suitable for 16-bit/18-bit testing (value based on signal frequency)

SOFTWARE NEEDED

- ▶ [ACE](#) evaluation software
- ▶ [ADAQ4001](#) or [ADAQ4003 ACE plugin](#)

GENERAL DESCRIPTION

The ADAQ4001 and ADAQ4003 μ Module® data acquisition system evaluation kit (EVAL-ADAQ4001FMCZ/EVAL-ADAQ4003FMCZ) contains the EVAL-ADAQ4001PMDZ or EVAL-ADAQ4003PMDZ peripheral module (Pmod) board and the EVAL-PMD-IB1Z Pmod to field programmable grid array (FPGA) mezzanine card (FMC) interposer board that interfaces with the system demonstration controller board (EVAL-SDP-CH1Z) via a 160-pin FMC connector, as shown in [Figure 1](#).

The ADAQ4001 μ Module and the ADAQ4003 μ Module combine multiple common signal processing and conditioning blocks into a single device that includes a low noise, fully differential analog-to-digital converter (ADC) driver, a stable reference buffer, a high resolution, 16-bit or 18-bit, 2 MSPS successive approximation register (SAR) ADC, and the critical passive components necessary for optimum performance.

The EVAL-ADAQ4001PMDZ and the EVAL-ADAQ4003PMDZ on-board components include the following:

- ▶ The [ADR4550](#) high precision, buffered band gap, 5.0 V voltage reference (see [Figure 25](#))
- ▶ An optional [ADA4898-1](#) high voltage, low noise, low distortion, unity-gain stable, high speed op amp (see [Figure 26](#))
- ▶ An optional [AD8251](#) programmable gain in-amp (see [Figure 26](#))
- ▶ The [LT5400-4](#) quad matched, low drift, resistor network

Note that J1 and J2 on the EVAL-ADAQ4001PMDZ and the EVAL-ADAQ4003PMDZ provide low noise analog signal sources.

For full details on the ADAQ4001 or the ADAQ4003, see the ADAQ4001 or the ADAQ4003 data sheet, which must be consulted in conjunction with this user guide when using the EVAL-ADAQ4001FMCZ/EVAL-ADAQ4003FMCZ.

TABLE OF CONTENTS

Features.....	1	Evaluation Board Setup Procedures.....	10
Evaluation Board Kit Contents.....	1	ACE Software Operation.....	12
Equipment Needed.....	1	Launching the Software.....	12
Software Needed.....	1	Description of Analysis View Window.....	15
General Description.....	1	Waveform Tab.....	17
EVAL-ADAQ4001FMCZ or EVAL- ADAQ4003FMCZ Evaluation Board Kit Photograph.....	4	Histogram Tab.....	17
Evaluation Board Hardware.....	5	FFT Tab.....	17
Setting Up the EVAL-ADAQ4001FMCZ and EVAL-ADAQ4003FMCZ Evaluation Kit.....	5	INL and DNL Tab.....	17
EVAL-SDP-CH1Z (SDP-H1) Board.....	5	Troubleshooting.....	19
Power Supplies.....	6	Evaluation Board Software Troubleshooting....	19
Analog Inputs.....	7	Hardware Troubleshooting.....	19
Link Configuration for Different Gain Options....	8	Evaluation Board Schematics and Silkscreens... 20	
Evaluation Board Software.....	9	EVAL-ADAQ4001PMDZ and EVAL- ADAQ4003PMDZ.....	20
Software Installation Procedures.....	9	EVAL-PMD-IB1Z.....	24
		Ordering Information.....	29
		Bill of Materials.....	29

REVISION HISTORY**10/2022—Rev. A to Rev. B**

Changes to Figure 26.....	21
Changes to Figure 27.....	22

5/2021—Rev. 0 to Rev. A

Added EVAL-ADAQ4001FMCZ.....	1
Added ADAQ4001.....	1
Added EVAL-ADAQ4001PMDZ.....	1
Changes to Software Needed Section	1
Changes to Figure 2.....	5
Changes to Power Supplies Section.....	6
Changes to Table 2.....	7
Changes to Evaluation Board Software Section.....	9
Added Figure 8 to Figure 14; Renumbered Sequentially.....	9
Deleted Figure 8 to Figure 20; Renumbered Sequentially.....	9
Added Figure 15.....	10
Deleted Figure 21, Figure 22, and Figure 23.....	10
Added ACE Software Operation Section	12
Deleted Software Operation Section, Figure 25 to Figure 32, and Table 4; Renumbered Sequentially.....	12
Added Figure 16, Figure 17, Figure 18, and Figure 19	12
Added Figure 20, Figure 21, and Figure 22.....	15
Added Figure 23 and Figure 24.....	17
Changed ADAQ400x Evaluation Board Software Troubleshooting Section to Evaluation Board Software Troubleshooting Section.....	19
Changes to Hardware Troubleshooting Section.....	19
Added EVAL-ADAQ4001PMDZ and EVAL-ADAQ4003PMDZ Section and Figure 25 to Figure 31	20
Deleted EV-ADAQ4003PMDZ Section and Figure 33 to Figure 39.....	20

TABLE OF CONTENTS

9/2020—Revision 0: Initial Version

EVAL-ADAQ4001FMCZ OR EVAL-ADAQ4003FMCZ EVALUATION BOARD KIT PHOTOGRAPH

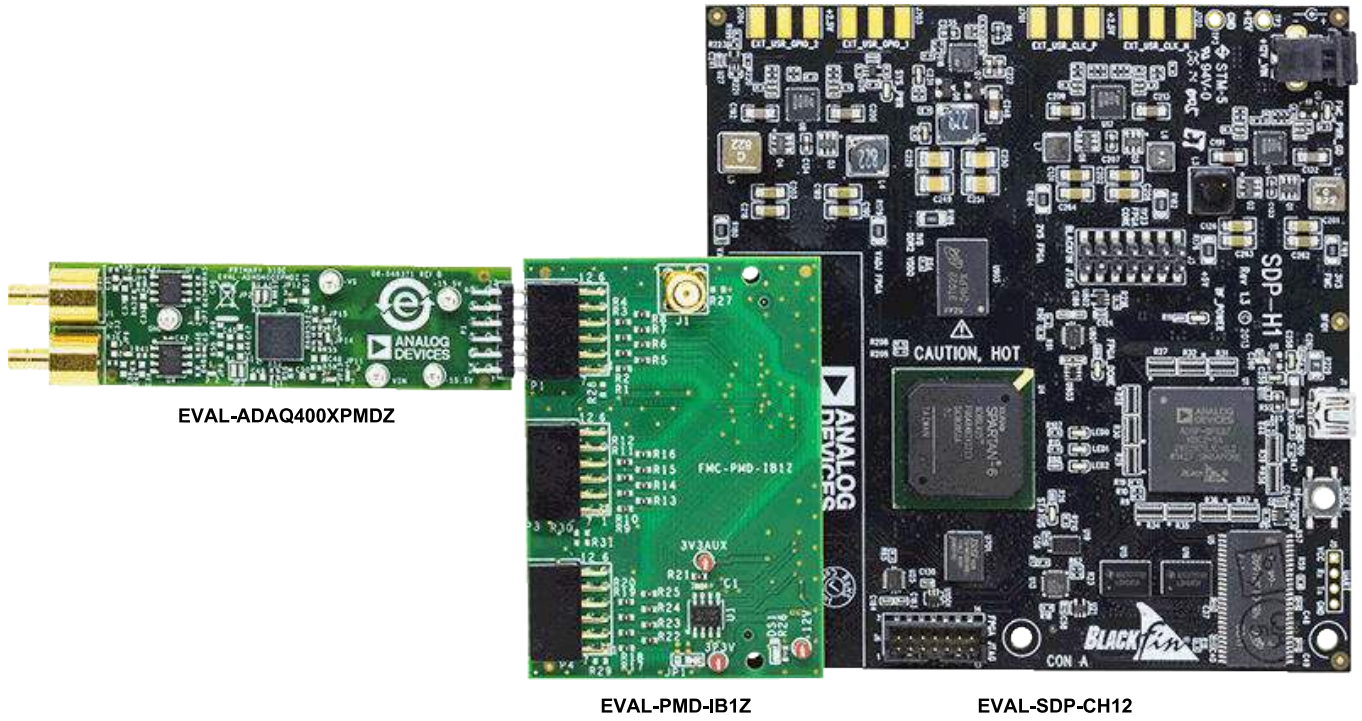

Figure 1.

EVALUATION BOARD HARDWARE

SETTING UP THE EVAL-ADAQ4001FMCZ AND EVAL-ADAQ4003FMCZ EVALUATION KIT

Figure 2 shows the simplified block diagram of the EVAL-ADAQ4001PMDZ and EVAL-ADAQ4003PMDZ. Figure 25 to Figure 26 show the EVAL-ADAQ4001PMDZ and EVAL-ADAQ4003PMDZ board schematics, which consist of the ADAQ4001 μModule or ADAQ4003 μModule (U5), the ADR4550 (U1), the ADA4898-1 (U4 and U7), the AD8251 (A1), the ADP5070 (U3), the LT3032 (U2), and the LT3023 (U6). The EVAL-ADAQ4001PMDZ and EVAL-ADAQ4003PMDZ are flexible designs that enable the user to select components and operate the evaluation boards from an adjustable bench top power supply.

EVAL-SDP-CH1Z (SDP-H1) BOARD

The EVAL-ADAQ4001FMCZ/EVAL-ADAQ4003FMCZ evaluation kit uses a serial port interface (SPI) and requires the system demon-

stration platform (SDP-H1) to capture the data via a graphic user interface (GUI) (see Figure 1). The SDP-H1 requires power from a 12 V wall adapter. The SDP-H1 has a Xilinx® Spartan®-6 and an ADSP-BF527 processor with connectivity to the PC through a USB 2.0 high speed port.

The SDP-H1 has an FMC low pin count connector with fully differential low voltage differential signaling (LVDS) and singled-ended, low voltage, CMOS support. The SDP-H1 also has a 120-pin connector that exposes the Blackfin® processor peripherals. This connector provides a configurable serial, parallel I²C and SPI and general-purpose input/output (GPIO) communication lines to the attached daughter board.

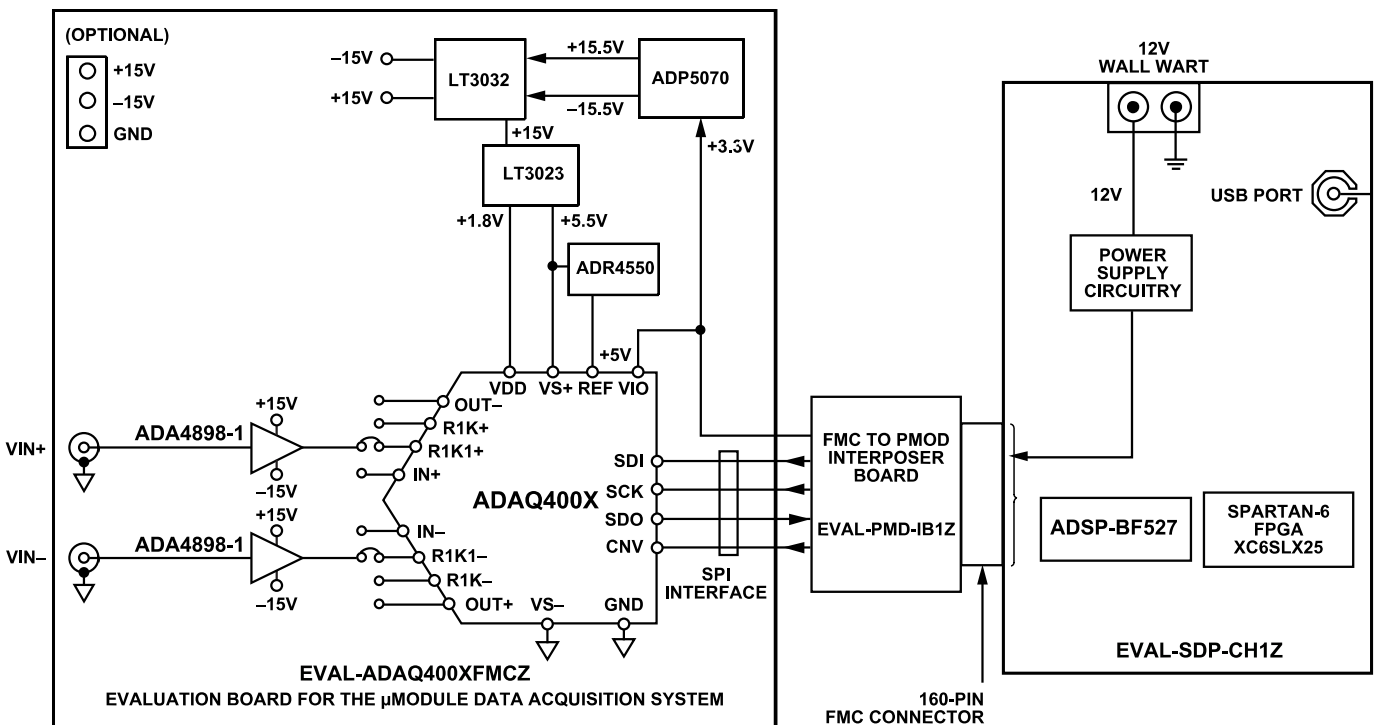

Figure 2. Simplified Evaluation Board Block Diagram

EVALUATION BOARD HARDWARE

POWER SUPPLIES

The [SDP-H1](#) supplies 3.3 V to power the rails for the different components on the EVAL-ADAQ4001FMCZ/EVAL-ADAQ4003FMCZ.

The [ADAQ4001](#) μ Module and the [ADAQ4003](#) μ Module use four power supply pins: the ADC driver positive supply (VS+), the ADC driver negative supply (VS-), the core ADC supply (VDD), and the digital input and output interface supply (VIO). The VIO pin allows the direct interface with any logic c between 1.8 V and 5.5 V. To reduce the number of supplies required, VIO and VDD can be tied together for a 1.8 V operation. A combination of the [ADP5070](#) (dual, high performance dc-to-dc switching regulator), the [LT3032](#) (dual, low noise, positive and negative low dropout voltage linear regulator), and the [LT3023](#) (dual, micropower, low noise, low dropout regulator) can generate independently regulated positive and negative rails for all four power supply pins, including ± 15 V rails for any additional signal conditioning.

Table 1. Default Power Supplies Available on the [EVAL-ADAQ4001PMDZ](#) and the [EVAL-ADAQ4003PMDZ](#)

Power Supply (V)	Function	Components Used
+5.5	Reference rail	ADP5070, LT3032, LT3023
± 15	Amplifier rails	ADP5070, LT3032
+1.8, +3.3, or +5.5	μ Module rails	ADP5070, LT3032, LT3023

Each supply is decoupled at the EVAL-ADAQ4001PMDZ and EVAL-ADAQ4003PMDZ entrance and device connection. A single, on-board ground plane minimizes the effect of the high frequency noise interference.

In addition, the EVAL-ADAQ4001PMDZ and the EVAL-ADAQ4003PMDZ can be powered from a benchtop power supply of ± 15.5 V. The +15.5 V, -15.5 V, and GND test points are available on board to support this function. When bench power is used, the on-board power supplies are no longer required, and the link between the output pin of the ADP5070 must be removed, that is, uninstall R20 and R22.

Take the following steps to set up the EVAL-ADAQ4001PMDZ or the EVAL-ADAQ4003PMDZ when using a benchtop power supply of ± 15.5 V:

1. Connect the EVAL-ADAQ4001PMDZ or the EVAL-ADAQ4003PMDZ to the EVAL-PMD-IB1Z interposer board at the P1 header (see [Figure 1](#)).
2. Connect the EVAL-PMD-IB1Z interposer board to the SDP-H1 via the 160-pin FMC connector.
3. Connect the USB and a 12 V power adapter to the SDP-H1. Ensure that the software and drivers are installed.
4. Connect the +15.5 V and -15.5 V bench supplies to the +15.5 V and -15.5 V test points on the EVAL-ADAQ4001PMDZ or the EVAL-ADAQ4003PMDZ (see [Figure 3](#)). Connect the bench supply ground to the GND test point as shown in [Figure 3](#).

5. Power up the benchtop supply. The +15.5 V supply rail draws approximately 25 mA, and the -15.5 V supply rail draws approximately 20 mA.

The EVAL-ADAQ4001PMDZ or the EVAL-ADAQ4003PMDZ is now ready to use. See the [Evaluation Board Software](#) section for details on using the [Analysis | Control | Evaluation \(ACE\)](#) software. Note that by default, the EVAL-ADAQ4001PMDZ and the EVAL-ADAQ4003PMDZ are set up to accept a differential input at J1 and J2 with a 22 V range.

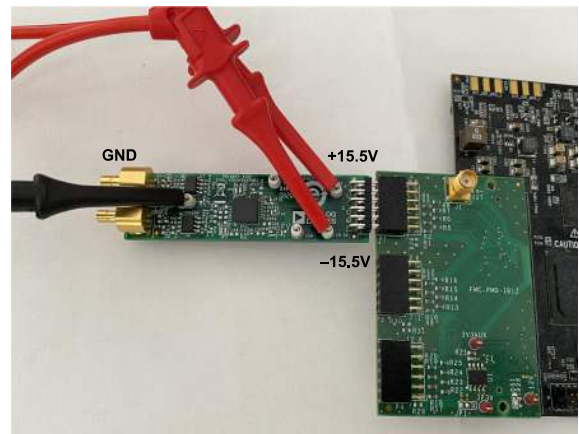

Figure 3. EVAL-ADAQ4001PMDZ and EVAL-ADAQ4003PMDZ External Supply (Optional) Connections

EVALUATION BOARD HARDWARE

ANALOG INPUTS

The analog inputs of the [EVAL-ADAQ4001PMDZ](#) and the [EVAL-ADAQ4003PMDZ](#), J1 and J2, are Subminiature Version B (SMB) connectors. These inputs are fed to the [ADA4898-1](#). J1 and J2 are buffered with dedicated amplifier circuitry, U4 and U7, as shown in [Figure 26](#). The circuit enables different configurations, input range scaling, filtering, amplifiers and supplies, and the addition of a dc component. The analog input amplifiers are set as unity-gain buffers at the factory.

The analog inputs are fully differential by default. If a single-ended bipolar input is desired, such as ± 10 V, the EVAL-ADAQ4001PMDZ or the EVAL-ADAQ4003PMDZ can be configured for single-ended to differential conversion by changing JP6 to Pin B to Pin COM and by applying the single-ended input at Connector J1 (see [Table 2](#)).

For dynamic performance, a fast Fourier transform (FFT) test can be performed by applying a low distortion ac source. For low frequency testing, the audio precision source, such as the SYS-2700 series, can be used directly with the evaluation boards. Different precision sources can be used with additional filtering.

Table 2. Jumper Details with Factory Default Setting

Link	Default	Function	Comment
JP1	Not populated	Gain options	Fully differential or single-ended configuration.
JP2	B1 and B2, A1 and A2	μ Module input	The ADAQ4001 or the ADAQ4003 has a gain of 0.454 (22 V range). See the ADAQ4001 or the ADAQ4003 data sheet for other gains.
JP3	B1 and B2, A1 and A2	μ Module input	The ADAQ4001 or the ADAQ4003 has a gain of 0.454 (22 V range). See the ADAQ4001 or the ADAQ4003 data sheet for other gains.
JP4	Pin A to Pin COM	Synchronize the switching frequency to CNV	To set the switching frequency to 1.2 MHz, pull the SYNC/FREQ pin of the ADP5070 low or Pin B to Pin COM.
JP5	Pin A to Pin COM	Op amp or in-amp	Connect the J1 input to the ADA4898-1 op amp.
JP6	Pin A to Pin COM	Op amp or in-amp	Connect the J2 input to the ADA4898-1 op amp.
JP6	Pin A to Pin COM	Single-ended or differential input	Differential input by default. Connect Pin B to COM for a single-ended input and connect JP7 to Pin B to Pin COM.
JP7	Pin B to Pin COM	Op amp or in-amp	Connect the ADA4898-1 op amp to the ADAQ4001 μ Module or the ADAQ4003 μ Module.
JP8	Pin B to Pin COM	Amplifier or in-amp	Connect Pin A to Pin COM to the output of the AD8251 .
JP9	Pin B to Pin COM	Gain setting pin (LSB)	Refer to the AD8251 data sheet for the truth table logic levels for transparent gain mode.
JP10	Pin B to Pin COM	Gain setting pin (MSB)	Refer to the AD8251 data sheet for the truth table logic levels for transparent gain mode.
JP11	Pin A to Pin COM	Power	Differential amplifier positive supply. Tied to ground.
JP12	Pin A to Pin COM	Differential amplifier power mode	Differential amplifier positive supply. Tied to ground.
JP13	Pin A to Pin COM	Differential amplifier power down	Normal mode. See the ADAQ4001 or the ADAQ4003 data sheet.
JP14	Pin A to Pin COM	Reference buffer power down	Powered up. See the ADAQ4001 or the ADAQ4003 data sheet.
JP15	Pin A to Pin COM	Differential amplifier power down	Powered up. See the ADAQ4001 or the ADAQ4003 data sheet.

EVALUATION BOARD HARDWARE

LINK CONFIGURATION FOR DIFFERENT GAIN OPTIONS

Multiple link options must be set correctly for the appropriate gain configuration of the ADAQ4001 or the ADAQ4003. Table 3 details the different gain positions for the links of the EVAL-ADAQ4001PMDZ and the EVAL-ADAQ4003PMDZ.

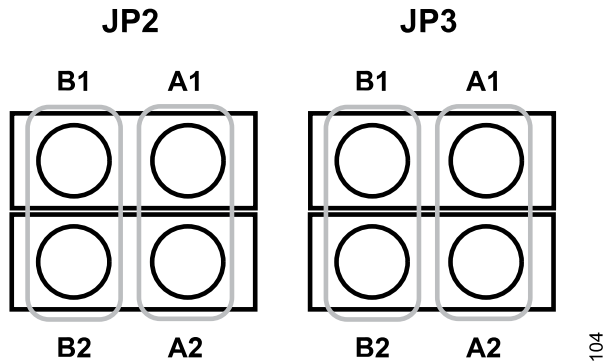

Figure 4. Gain = 0.454

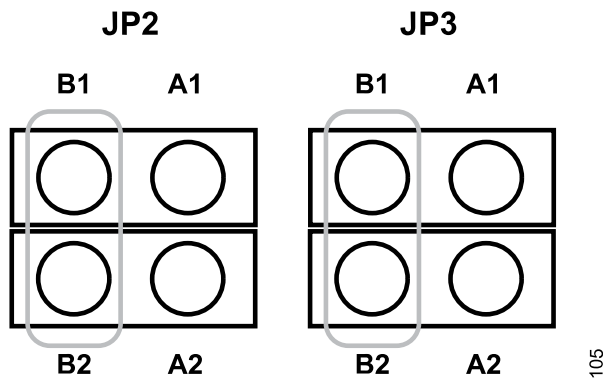

Figure 5. Gain = 0.9

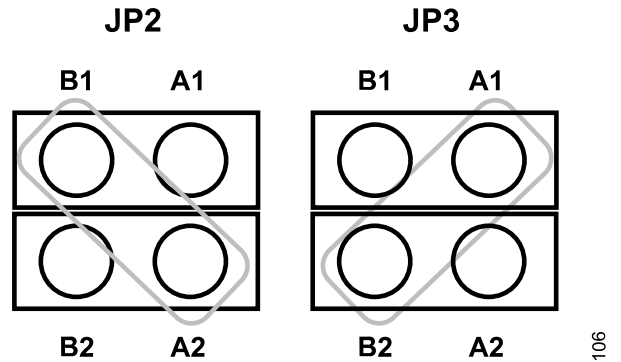

Figure 6. Gain = 1

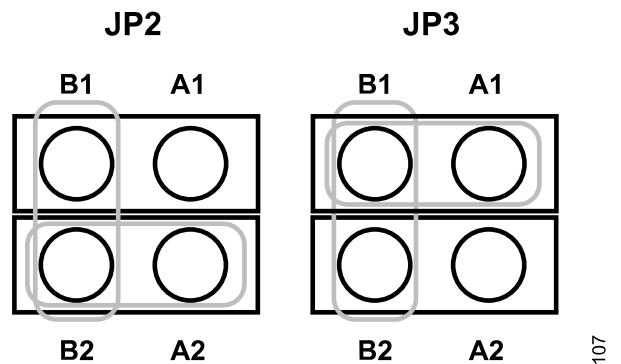

Figure 7. Gain = 1.9

Table 3. The Different Gain Positions Available for the Links of the EVAL-ADAQ4001PMDZ or the EVAL-ADAQ4003PMDZ

Gain	Input Range (V)	Input Signal on Pins	Test Conditions
0.454	±11	R1K1- and R1K1+	For JP2, tie A1 to A2 and tie B1 to B2, and for JP3, tie A1 to A2 and tie B1 to B2 (see Figure 4).
0.9	±5.5	R1K1- and R1K1+	For JP2, tie B1 to B2, and for JP3, tie B1 to B2 (see Figure 5).
1	±5	R1K- and R1K+	For JP2, tie A2 to B1, and for JP3, tie A1 to B2 (see Figure 6).
1.9	±2.6	R1K1-, R1K-, R1K1+, and R1K+	For JP2, tie B1 to A2 and B2, and for JP3, tie B2 to A1 and B1 (see Figure 7).

EVALUATION BOARD SOFTWARE

SOFTWARE INSTALLATION PROCEDURES

Download the [ACE](#) evaluation software from the EVAL-ADAQ4001FMCZ/EVAL-ADAQ4003FMCZ evaluation kit page. Install the software on a PC before using the EVAL-ADAQ4001FMCZ/EVAL-ADAQ4003FMCZ kit. Download the [ADAQ4001](#) or [ADAQ4003](#) ACE plugin from the EVAL-ADAQ4001FMCZ/EVAL-ADAQ4003FMCZ page or from the plugin manager in ACE.

Perform the following steps to complete the installation process:

1. Install the ACE evaluation software.
2. Install the [SDP-H1](#) drivers.
3. Install the ADAQ4001 or ADAQ4003 plugin. The [ACE Quick-start](#) page shows the plugin installation guide.

Warning

Install the ACE software and SDP-H1 drivers before connecting the EVAL-ADAQ4001FMCZ/EVAL-ADAQ4003FMCZ and the SDP-H1 to the USB port of the PC to ensure that the evaluation system is properly recognized when it is connected to the PC.

Installing the ACE Evaluation Software

To install the [ACE](#) evaluation software, take the following steps:

1. Download the ACE software to a Windows-based PC.
2. Double click the **ACEInstall.exe** file to begin the installation. By default, the ACE software is saved to the following location: **C:\Program Files (x86)\Analog Devices\ACE**.
3. A dialog box opens asking for permission to allow the program to make changes to the PC. Click **Yes** to start the installation process.
4. In the **ACE Setup** window, click **Next >** to continue the installation (see [Figure 8](#)).



Figure 8. ACE Software Install Confirmation

5. Read the software license agreement and click **I Agree** (see [Figure 9](#)).



Figure 9. License Agreement

6. Click **Browse...** to choose the install location and then click **Next >** (see [Figure 10](#)).

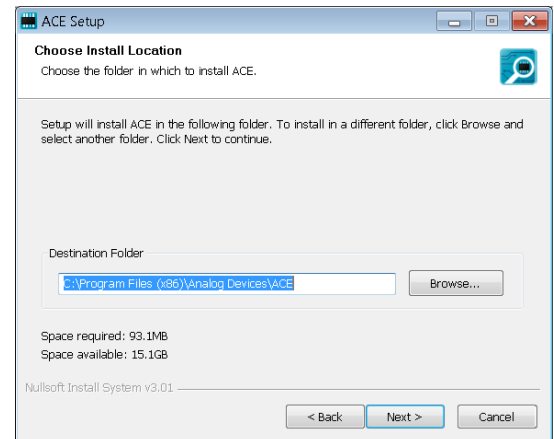

Figure 10. Choose Install Location

7. The ACE software components to install are preselected. Click **Install** (see [Figure 11](#)).

EVALUATION BOARD SOFTWARE

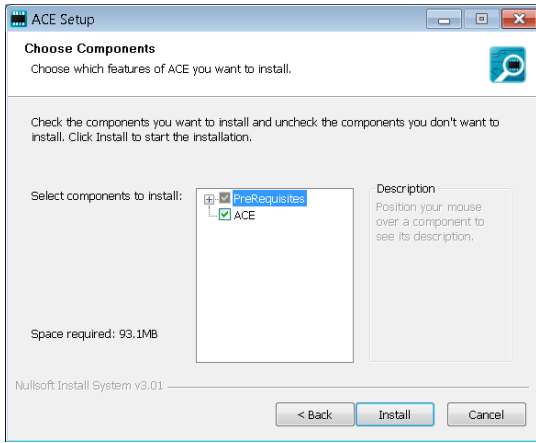

Figure 11. Choose Components

8. The **Windows Security** window opens (see Figure 12). Click **Install**. Figure 13 shows the installation in progress. No action is required.

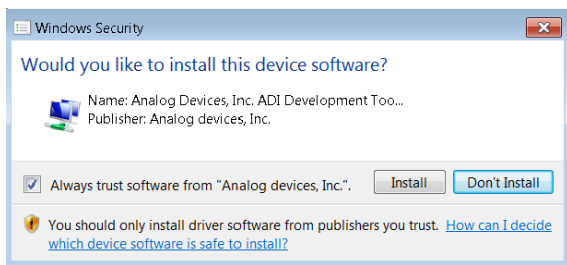

Figure 12. Windows Security Window

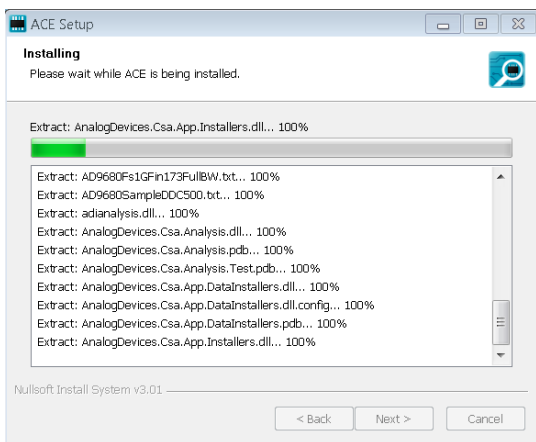

Figure 13. Installation in Progress

9. When the installation completes, click **Next >** (see Figure 14), and then click **Finish**.

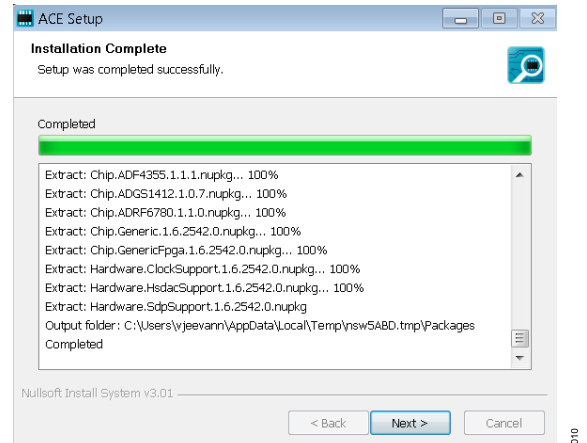

Figure 14. Installation Complete

EVALUATION BOARD SETUP PROCEDURES

The EVAL-ADAQ4001FCMZ/EVAL-ADAQ4003FCMZ connects to the **SDP-H1**. The SDP-H1 is the communication link between the PC and the EVAL-ADAQ4001FCMZ/EVAL-ADAQ4003FCMZ. Figure 1 shows a diagram of the connections between the EVAL-ADAQ4001FCMZ/EVAL-ADAQ4003FCMZ and the SDP-H1.

Connecting the EVAL-ADAQ4001FCMZ or EVAL-ADAQ4003FCMZ and the SDP-H1 to a PC

After installing the **ACE** software, take the following steps to set up the EVAL-ADAQ4001FCMZ/EVAL-ADAQ4003FCMZ and the SDP-H1:

1. Ensure that all configuration links are in the appropriate positions, as detailed from Figure 4 to Figure 7.
2. Connect the EVAL-ADAQ4001FCMZ/EVAL-ADAQ4003FCMZ securely to the 160-way connector on the SDP-H1. The EVAL-ADAQ4001FCMZ/EVAL-ADAQ4003FCMZ do not require an external power supply adapter.
3. Connect the SDP-H1 to the PC via the USB cable included in the SDP-H1 kit.

Verifying the Board Connection

After connecting the power and the USB cable from the SDP-H1 to the PC, take the following steps to verify the board connection:

1. After connecting the SDP-H1 to the PC, allow the **Found New Hardware Wizard** to run. If prompted by the operating system, choose to automatically search for the drivers for the SDP-H1.
2. Navigate to the **Device Manager** window of the PC (see Figure 15).
3. A dialog box opens asking for permission to allow the program to make changes to the computer. Click **Yes**.

EVALUATION BOARD SOFTWARE

4. The **Computer Management** window opens. In the list labeled **System Tools**, click **Device Manager**. If the **SDP-H1** driver software is installed, and the board is properly connected to the PC, **Analog Devices SDP-H1** is shown in the **ADI Development Tools** list in the **Device Manager** window, as shown in [Figure 15](#).

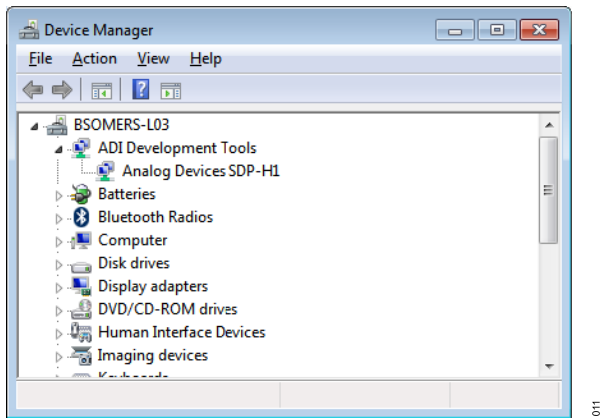

Figure 15. Device Manager Window

Disconnecting the EVAL-ADAQ4001FMCZ or the EVAL-ADAQ4003FMCZ

Disconnect power from the SDP-H1 or press the reset tact switch located alongside the mini USB port on the SDP-H1 before disconnecting the EVAL-ADAQ4001FMCZ/EVAL-ADAQ4003FMCZ from the SDP-H1.

ACE SOFTWARE OPERATION

LAUNCHING THE SOFTWARE

After the EVAL-ADAQ4001FMCZ/EVAL-ADAQ4003FMCZ and the SDP-H1 are properly connected to the PC, launch the ACE evaluation software by taking the following steps:

1. From the **Start** menu of the PC, click **All Programs > Analog Devices > ACE > ACE.exe** to open the ACE software main window shown in [Figure 16](#).
2. Connect the EVAL-ADAQ4001FMCZ/EVAL-ADAQ4003FMCZ and the SDP-H1 to the USB. If the EVAL-ADAQ4001FMCZ/EVAL-ADAQ4003FMCZ is not connected to the USB port via the SDP-H1 when the software launches, the **ADAQ4001 Eval Board** or **ADAQ4003 Eval Board** icon does not appear in the **Attached Hardware** section. To make the **ADAQ4001 Eval Board** or **ADAQ4003 Eval Board** icon appear, connect the EVAL-ADAQ4001FMCZ/EVAL-ADAQ4003FMCZ and the SDP-
3. Double click the **ADAQ4001 Eval Board** or **ADAQ4003 Eval Board** icon in the ACE software main window (see [Figure 16](#)) to open the board view window shown in [Figure 17](#).
4. Double click the **ADAQ4001** or **ADAQ4003** chip icon in the board view window (see [Figure 17](#)) to open the chip view window shown in [Figure 18](#). The on-board voltage reference provided by the **ADR4550** is 5.0 V, as shown in the board view window. Type the value of the reference voltage in the reference voltage box in the chip view window when using the external reference.
5. Click **Software Defaults** and then click **Apply Changes** to apply the default settings.
6. Click the **Proceed to Analysis** button to show the **Analysis** view window, as shown in [Figure 19](#).

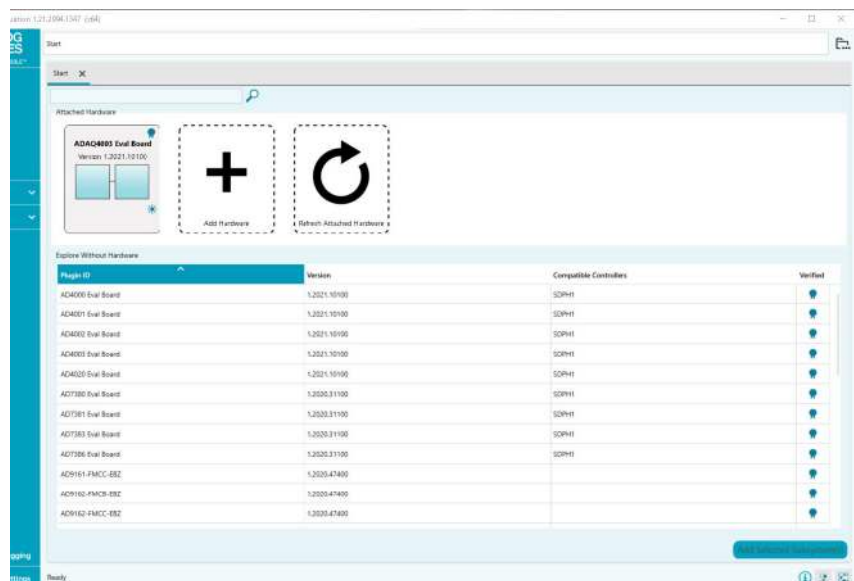

Figure 16. ACE Software Main Window

ACE SOFTWARE OPERATION

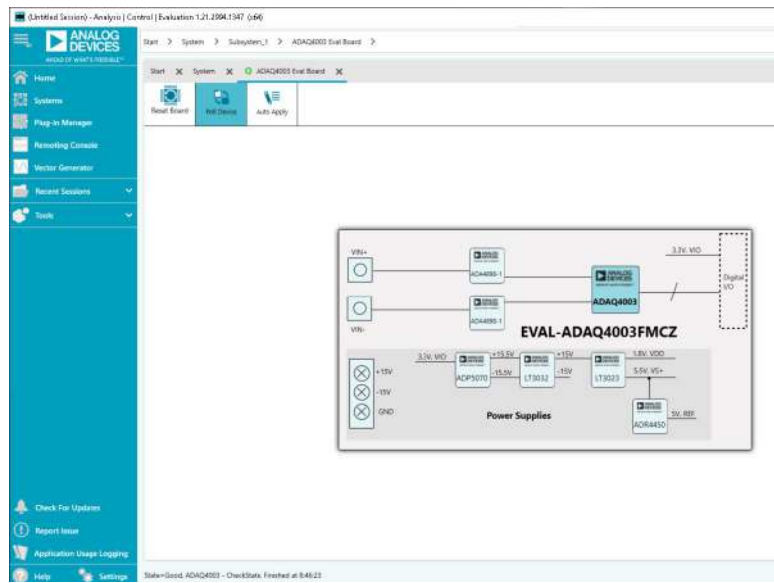

Figure 17. Board View Window

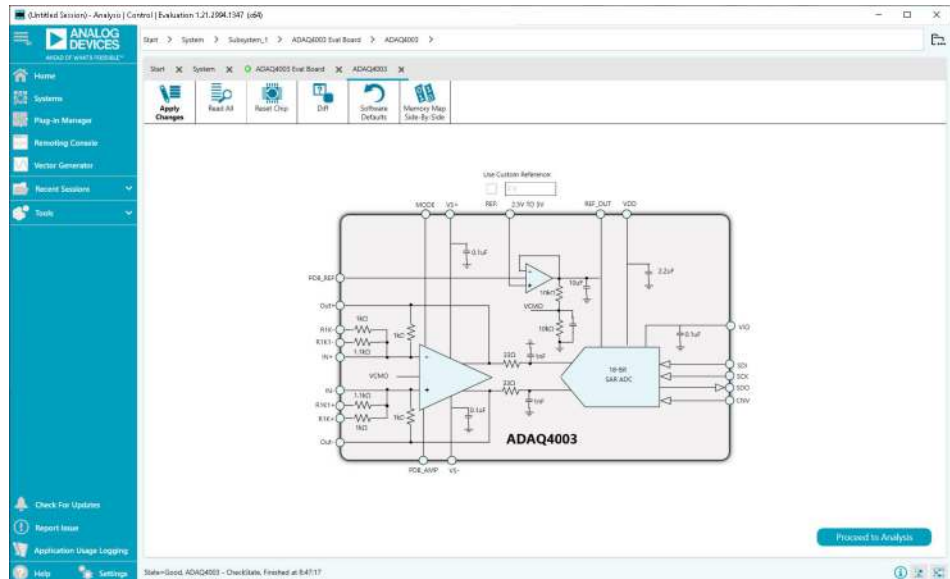

Figure 18. Chip View Window

ACE SOFTWARE OPERATION

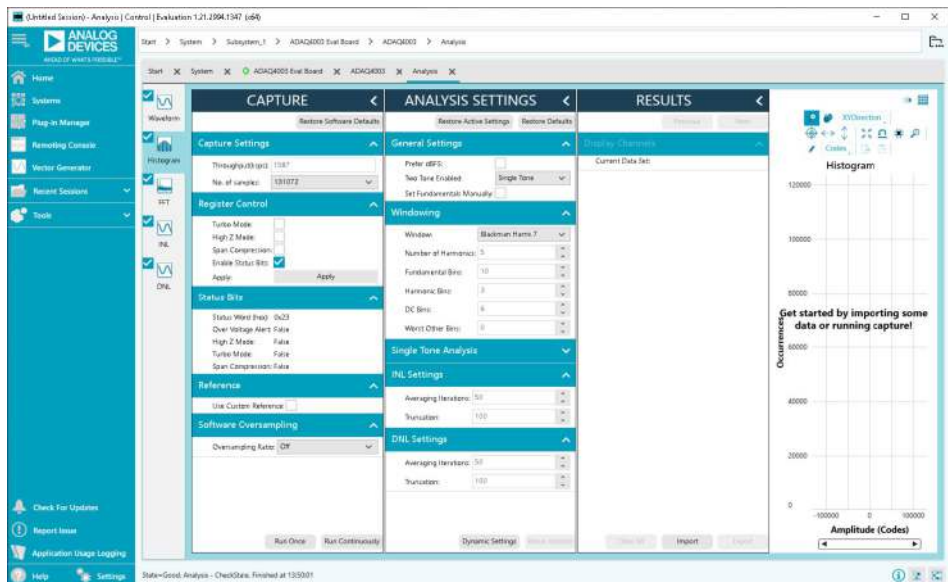

Figure 19. Analysis View Window

ACE SOFTWARE OPERATION

DESCRIPTION OF ANALYSIS VIEW WINDOW

The **Analysis** view window allows the user to showcase the performance of the **ADAQ4001** or the **ADAQ4003**. Before performing any measurements, set the capture settings (see the **CAPTURE**

section) and analysis settings (see the **ANALYSIS SETTINGS** section).

The **Analysis** view window contains the **Waveform** tab (see **Figure 20**), **Histogram** tab (see **Figure 21**), and **FFT** tab (see **Figure 22**).

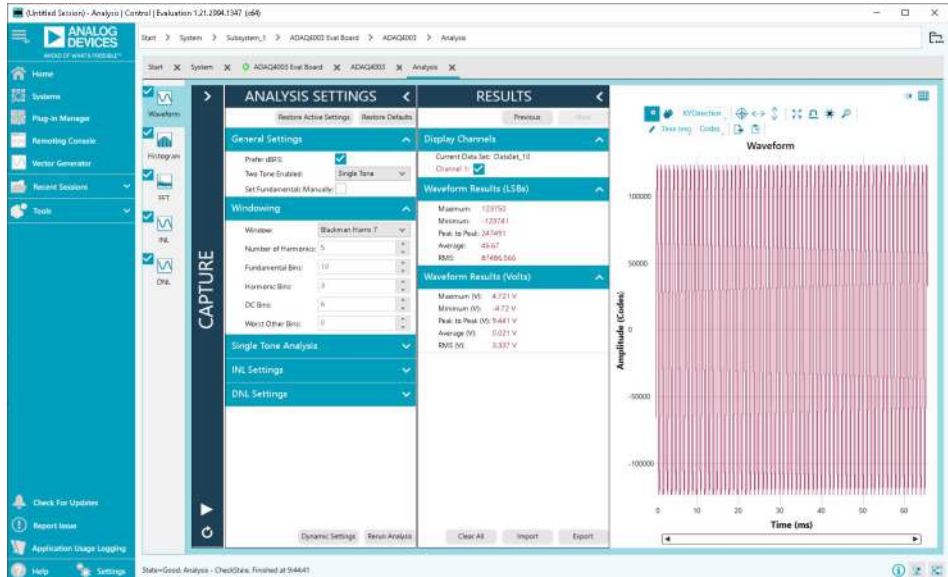

Figure 20. Waveform Tab

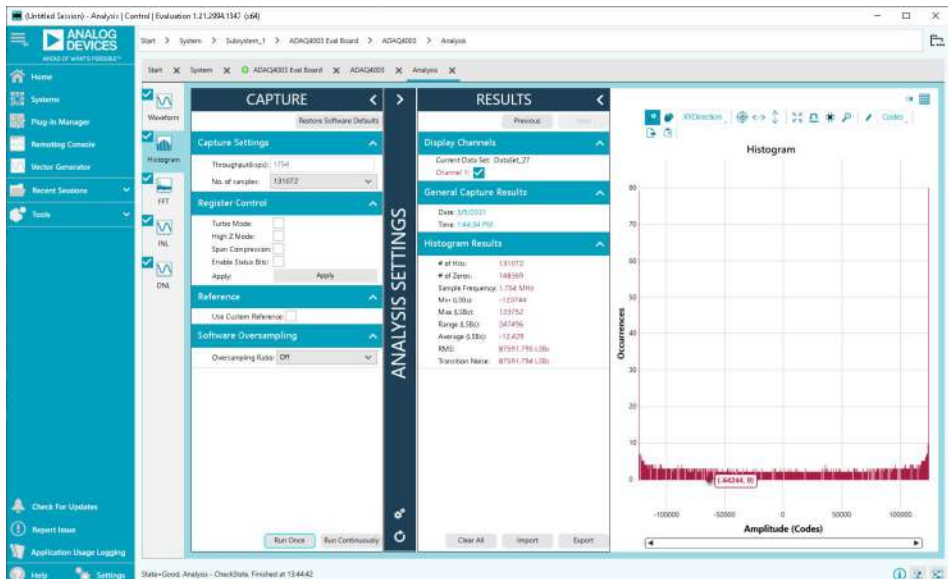

Figure 21. Histogram Tab

ACE SOFTWARE OPERATION

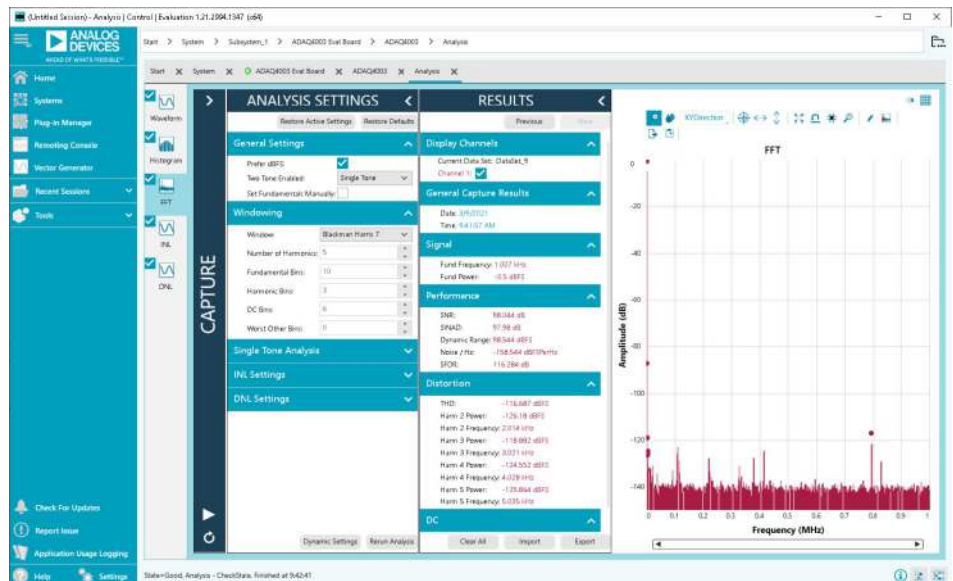

Figure 22. FFT Tab

CAPTURE

The **CAPTURE** pane contains the capture settings. These settings reflect onto the registers automatically before data capture.

The **Throughput(kSPS)** field in the **Capture Settings** section allows the user to set the throughput rate of the μ Module. The default maximum throughput rate is 1754 kSPS. The 2 MSPS throughput rate can only be set when the μ Module is in **Turbo Mode** with a minimum SCK rate of 75 MHz. Refer to the [ADAQ4001](#) data sheet and the [ADAQ4003](#) data sheet to determine the required SCK clock frequency for the selected 3-wire or 4-wire mode.

The **No. of samples** pulldown menu in the **Capture Settings** section allows the user to select the number of samples per capture.

Select the **Turbo Mode** check box in the **Register Control** section to enable a 2 MSPS throughput rate for the μ Module.

Select the **Span Compression** check box in the **Register Control** section to reduce the input range by 10% from the top and bottom of the range while still accessing the available μ Module codes.

Select the **Enable Status Bits** check box in the **Register Control** section to read the status registers after every after conversion.

Select the **Use Custom Reference** check box in the **Reference** section if the 5.0 V on-board reference is not used. Set the corresponding reference value in the **Reference Voltage** field.

When enabled, the **Oversampling Ratio** pulldown menu in the **Software Oversampling** section can be set between 2 and 256 and provide improved signal-to-noise ratio (SNR) performance. Refer to the [ADAQ4001](#) data sheet and the [ADAQ4003](#) data sheet

to determine the maximum oversampling ratio for the selected oversampling mode.

Click **Run Once** to start a data capture of the samples at the sample rate specified in the **No. of samples** pulldown menu. These samples are stored on the FPGA device and are only transferred to the PC when the sample frame is complete.

Click **Run Continuously** to start a data capture that gathers samples continuously with one batch of data at a time. This operation runs the **Run Once** operation continuously.

ANALYSIS SETTINGS

The **General Settings** section allows the user to set up the preferred configuration of the FFT analysis, including how many tones are analyzed. The fundamental is set manually.

The **Windowing** section allows the user to select the **Window** type used in the FFT analysis, set the **Number of Harmonics**, and set the number of **Fundamental Bins** that must be included.

The **Single Tone Analysis** section allows the user to select the fundamental frequency included in the FFT analysis.

The **INL Settings** section allows the user to set the **Averaging Iterations** and **Truncation** settings during the INL measurement.

The **DNL Settings** section allows the user to set the **Averaging Iterations** and **Truncation** settings during the DNL measurement.

ACE SOFTWARE OPERATION

RESULTS

Click **Export** to export the captured data. The waveform, histogram, and FFT data is stored in .xml files along with the values of the parameters at capture.

WAVEFORM TAB

The **Waveform** tab displays data in form of time vs. discrete data values with the results, as shown in [Figure 20](#).

The **Waveform** graph shows each successive sample of the μ Module output. The user can zoom in on and pan over the **Waveform** graph using the embedded waveform tools above the graph. Select the channels to display in the **Display Channels** section.

Under the **Display Units** pulldown menu, select **Codes** above the **Waveform** graph to select whether the **Waveform** graph displays in units of **Codes**, **Hex**, or **Volts**. The axis controls are dynamic.

When either **y-scale dynamic** or **x-scale dynamic** is selected, the corresponding axis width automatically adjusts to show the entire range of the μ Module results after each batch of samples.

HISTOGRAM TAB

The **Histogram** tab contains the histogram graph and the **RESULTS** pane, as shown in [Figure 21](#).

The **RESULTS** pane displays the information related to the dc performance.

The **Histogram** graph displays the number of hits per code within the sampled data. This graph is useful for dc analysis and indicates the noise performance of the device.

FFT TAB

The **FFT** tab displays fast Fourier transform (FFT) information for the last batch of samples gathered (see [Figure 22](#)).

When performing an FFT analysis, the **RESULTS** pane shows the **Noise** and **Distortion** performance of the [ADAQ4001](#) or the [ADAQ4003](#). **SNR** and other noise performance measurements, such as **SINAD**, **Dynamic Range**, noise density (**Noise / Hz**), and **SFDR**, are shown in the **Performance** section. The **THD** measurements, as well as the major harmonics contributing to the THD performance, are shown in the **Distortion** section.

INL AND DNL TAB

The **INL** tab (see [Figure 23](#)) and **DNL** tab (see [Figure 24](#)) display the linearity analysis. To perform a linearity test, apply a sinusoidal signal with 0.5 dB full scale to the [EVAL-ADAQ4001PMDZ](#) or the [EVAL-ADAQ4003PMDZ](#) at the J1 and J2 SMB inputs.

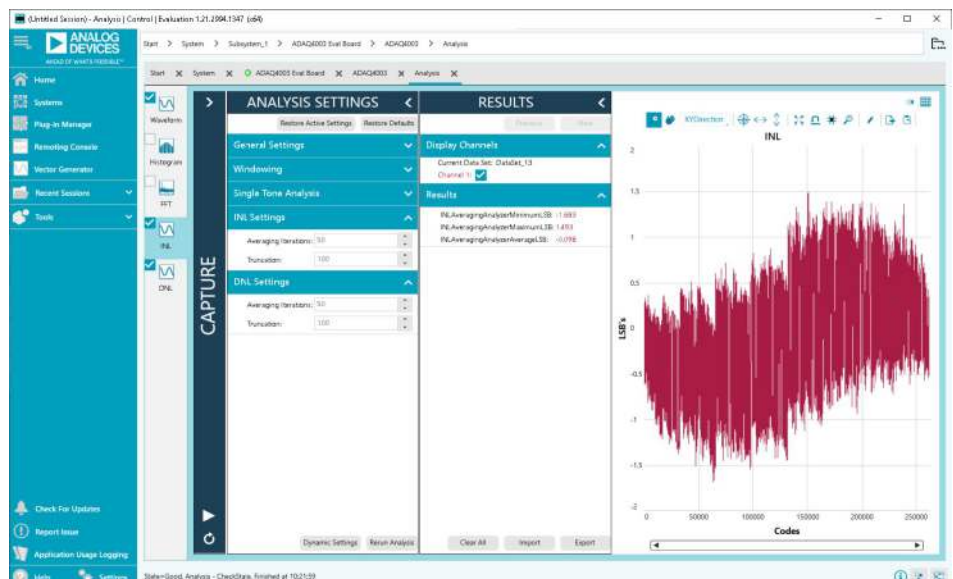

Figure 23. INL Tab

ACE SOFTWARE OPERATION



Figure 24. DNL Tab

TROUBLESHOOTING

EVALUATION BOARD SOFTWARE TROUBLESHOOTING

To troubleshoot the [ACE](#) evaluation software, take the following steps:

1. Install the ACE software before connecting the hardware to the PC (see the [Software Installation Procedures](#) section).
2. Restart the PC after the software installation process completes (both the ACE software and SDP-H1 drivers must be installed before the process completes).
3. After connecting the [SDP-H1](#) to the PC, allow the **Found New Hardware Wizard** to run before starting the ACE software.
4. If the EVAL-ADAQ4001FMCZ/EVAL-ADAQ4003FMCZ does not appear to be functioning, ensure that the EVAL-ADAQ4001FMCZ/EVAL-ADAQ4003FMCZ is connected to the SDP-H1 board and that the SDP-H1 is recognized in the **Device Manager** window, as shown in [Figure 15](#).
5. If connected to a slower USB port where the SDP-H1 cannot read quickly, a timeout error may result. In this case, do not read continuously or lower the number of samples taken.

HARDWARE TROUBLESHOOTING

To troubleshoot the hardware, take the following steps:

1. Check that the power is applied within the power ranges described in the [Setting Up the EVAL-ADAQ4001FMCZ and EVAL-ADAQ4003FMCZ Evaluation Kit](#) section.
2. Using a voltmeter, measure the voltage present at each of the test points: +15 V, -15 V, -VS, and VIN (3.3 V). Note that the LED1 on the SDP-H1 must be lit.
3. Launch the ACE software and read the data. If nothing happens, exit the software.
4. Power down the EVAL-ADAQ4001FMCZ/EVAL-ADAQ4003FMCZ and relaunch the ACE software.
5. When no data is read back, confirm that the EVAL-ADAQ4001FMCZ/EVAL-ADAQ4003FMCZ is connected to the SDP-H1 and that the SDP-H1 is recognized in the **Device Manager**, as shown in [Figure 15](#).
6. When the user is working with the software in standalone or offline mode (no hardware connected) and later chooses to connect hardware, close and relaunch the software.

EVALUATION BOARD SCHEMATICS AND SILKSCREENS

EVAL-ADAQ4001PMDZ AND EVAL-ADAQ4003PMDZ

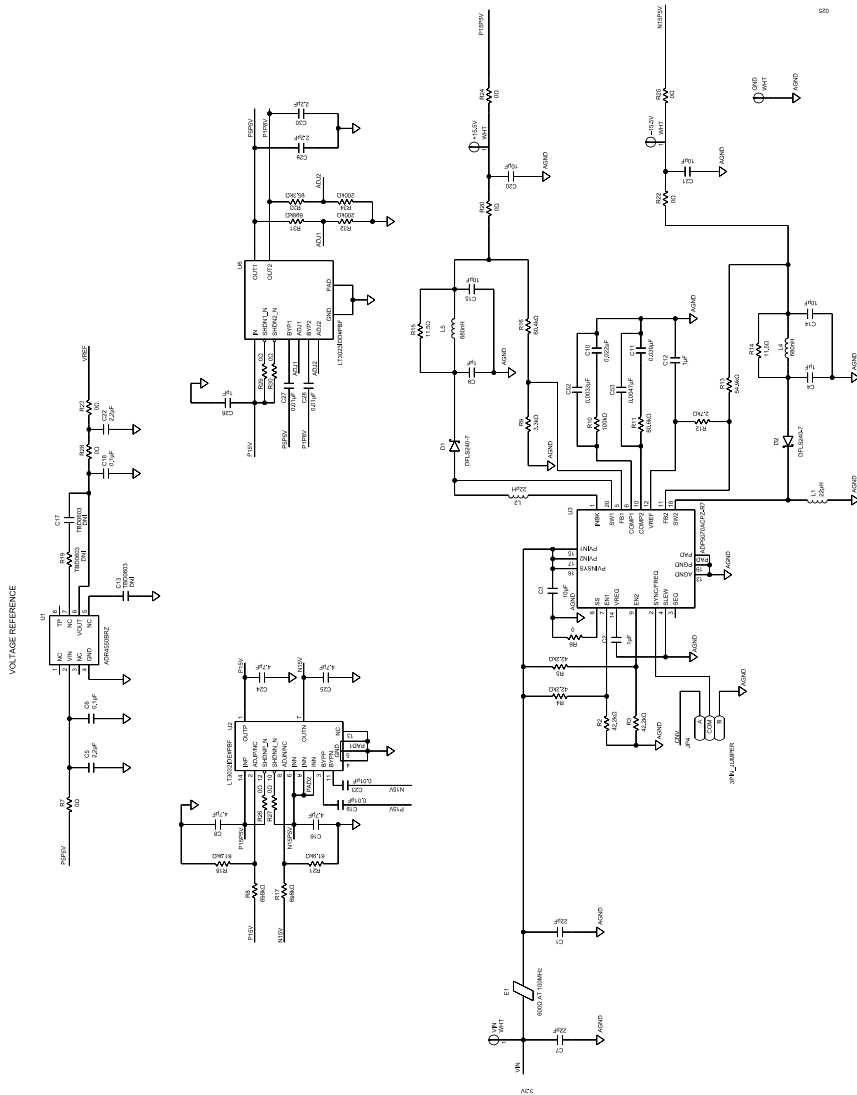

Figure 25. EVAL-ADAQ4001PMDZ and EVAL-ADAQ4003PMDZ Power Supplies and Voltage Reference

EVALUATION BOARD SCHEMATICS AND SILKScreens

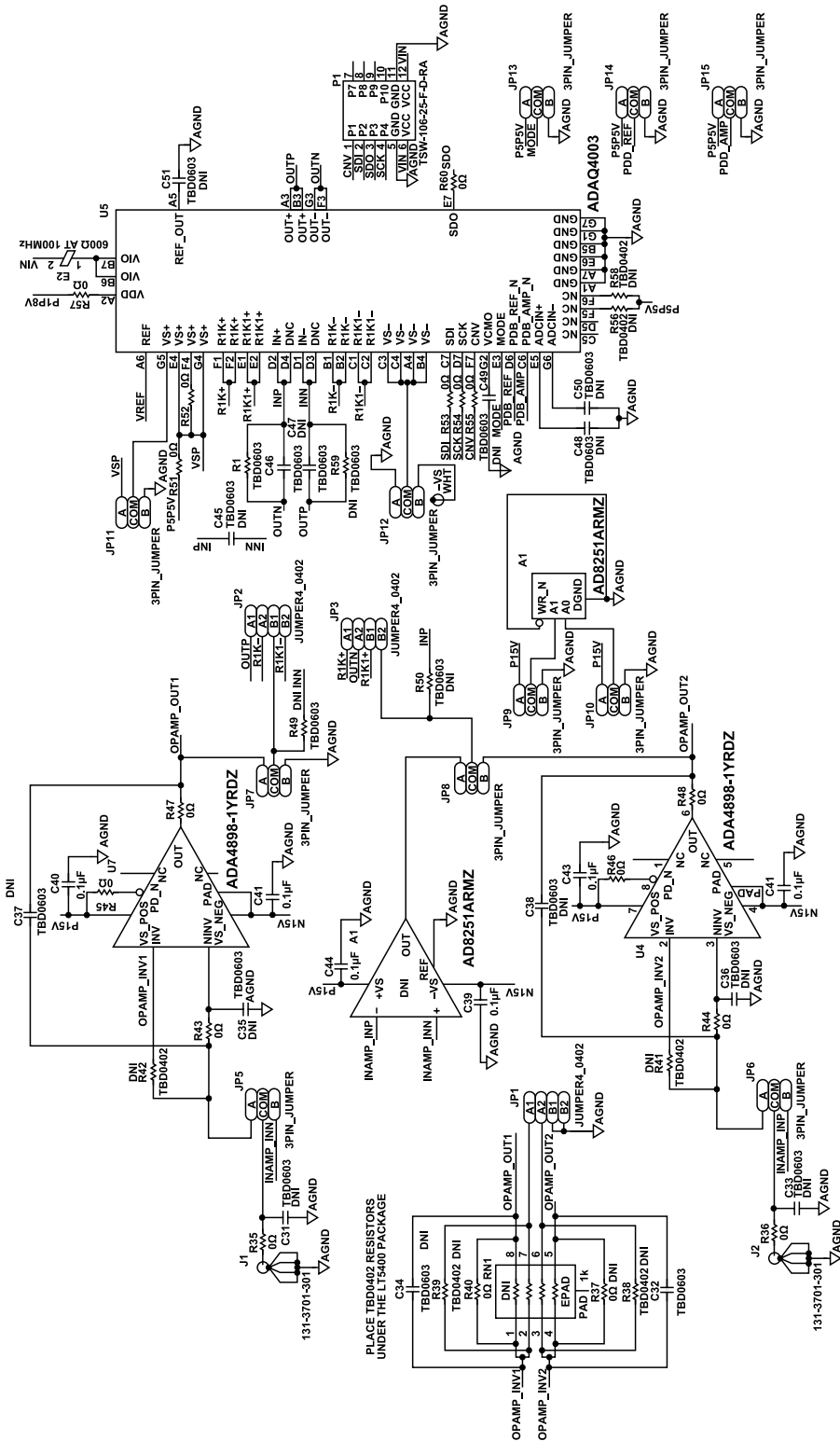

Figure 26. EVAL-ADAQ4001PMDZ and EVAL-ADAQ4003PMDZ μ Module and Signal Conditioning

EVALUATION BOARD SCHEMATICS AND SILKSCREENS

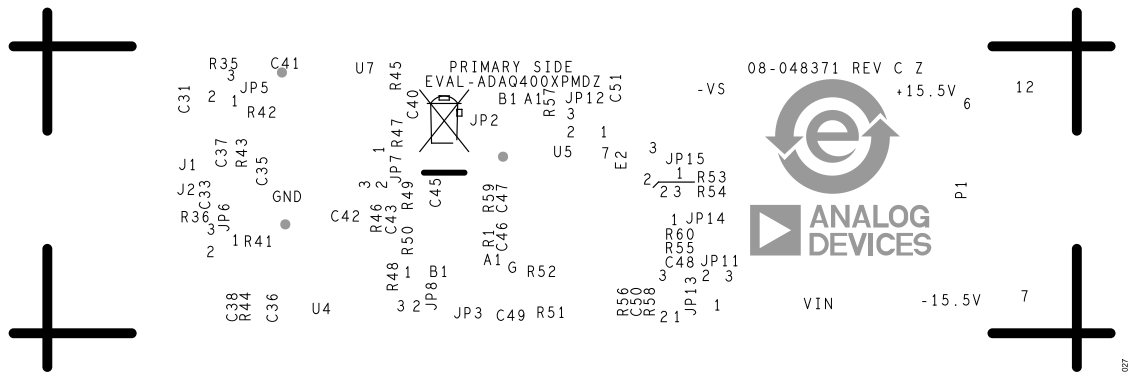

Figure 27. EVAL-ADAQ4001PMDZ and EVAL-ADAQ4003PMDZ Silkscreen, Top Layer

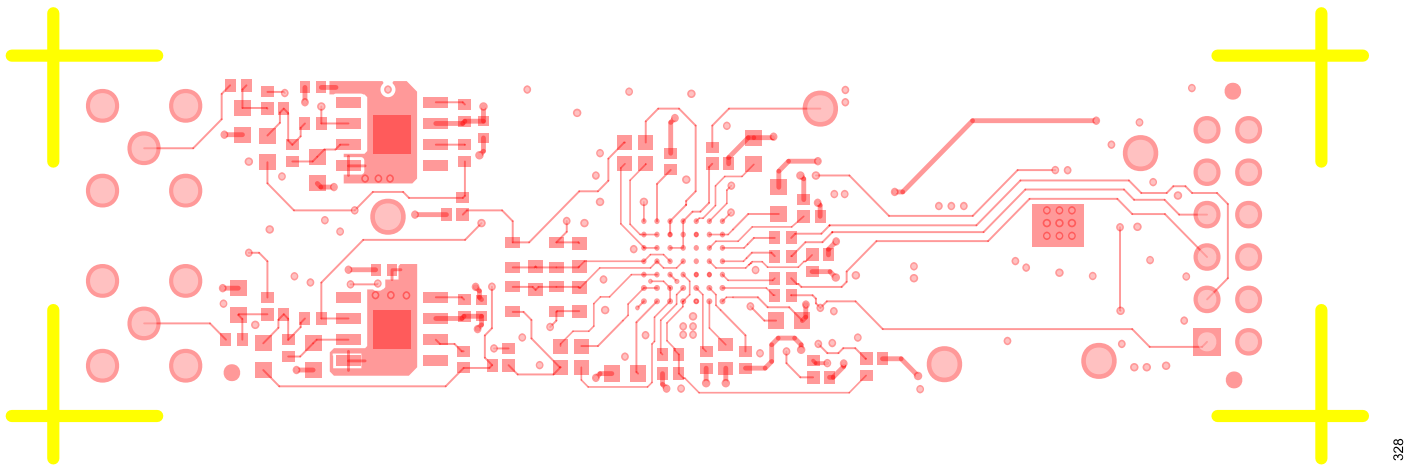

Figure 28. EVAL-ADAQ4001PMDZ and EVAL-ADAQ4003PMDZ, Layer 1

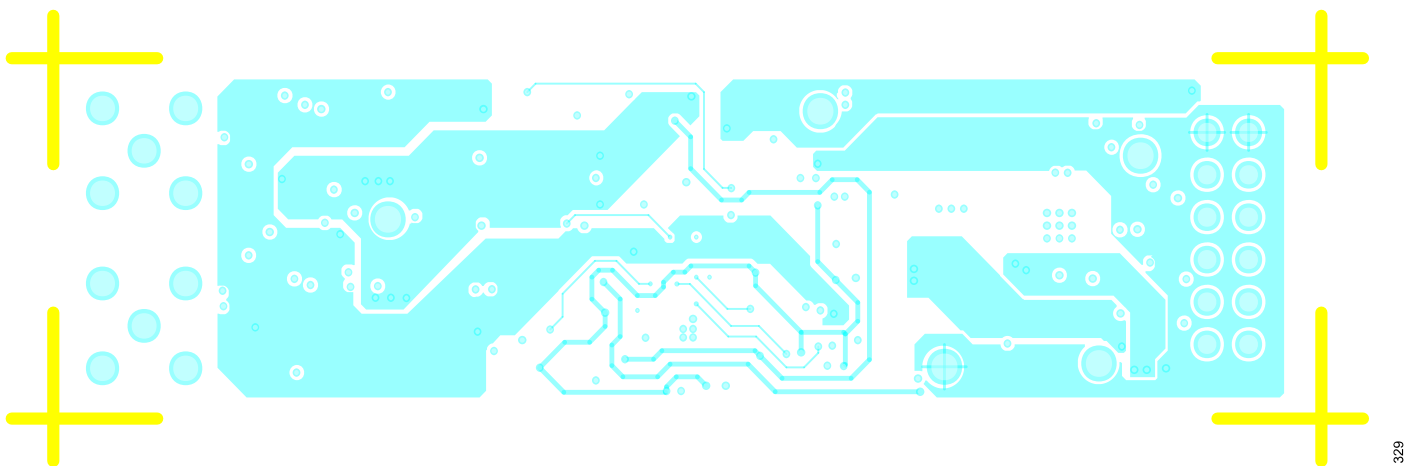

Figure 29. EVAL-ADAQ4001PMDZ and EVAL-ADAQ4003PMDZ, Layer 2

EVALUATION BOARD SCHEMATICS AND SILKSCREENS

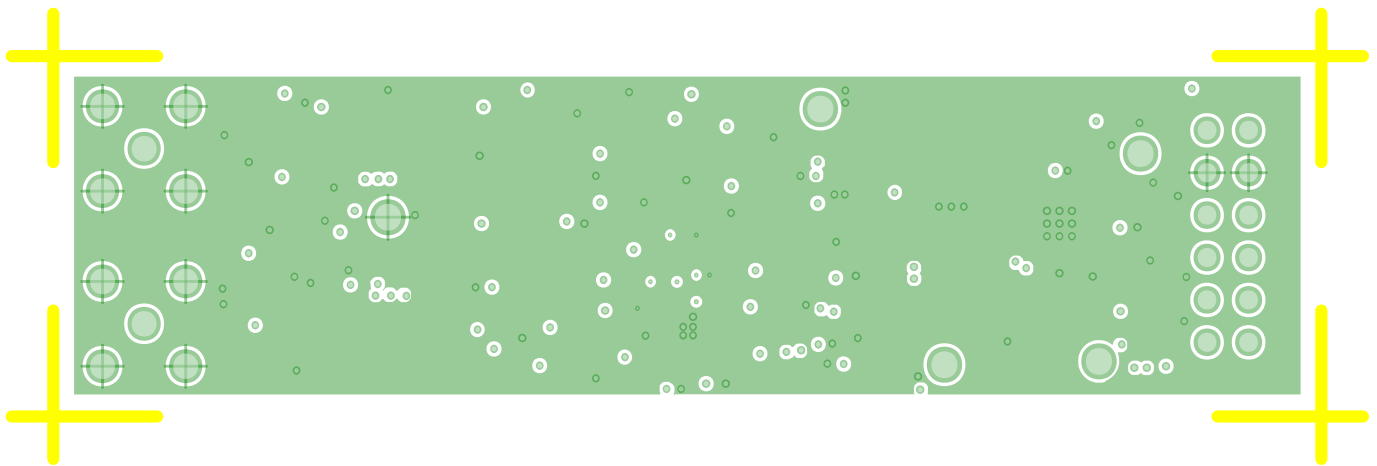

Figure 30. EVAL-ADAQ4001PMDZ and EVAL-ADAQ4003PMDZ, Layer 3 GND

330

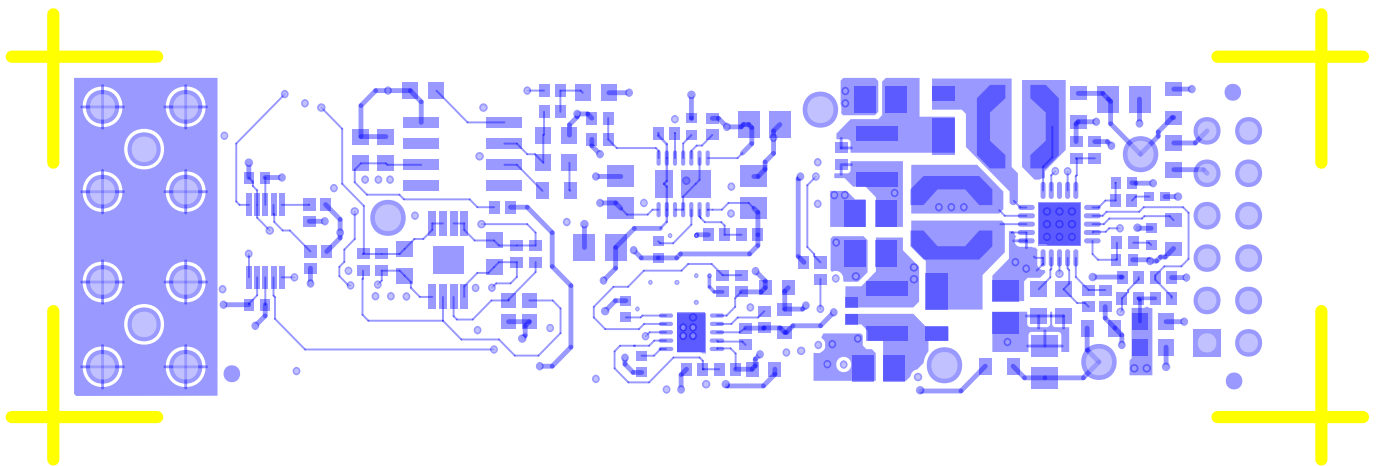

Figure 31. EVAL-ADAQ4001PMDZ and EVAL-ADAQ4003PMDZ, Layer 4 Secondary

331

EVALUATION BOARD SCHEMATICS AND SILKSCREENS

EVAL-PMD-IB1Z

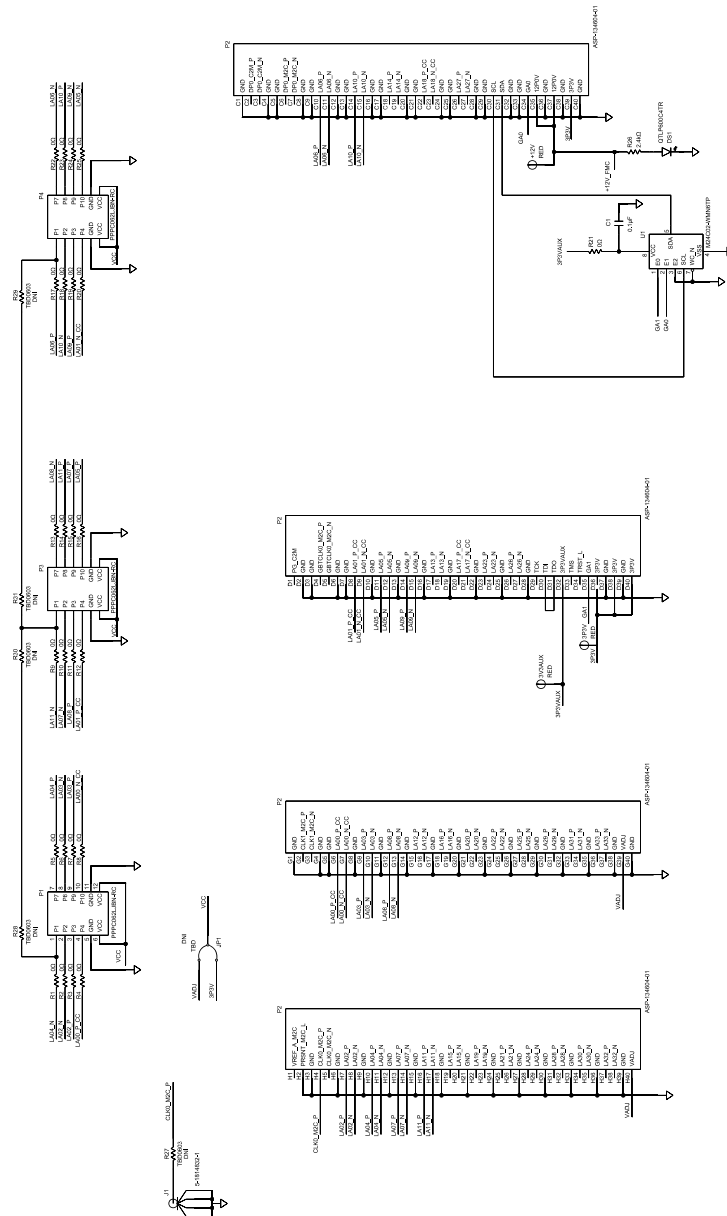

Figure 32. EVAL-PMD-IB1Z Interposer Schematic Diagram

EVALUATION BOARD SCHEMATICS AND SILKSCREENS

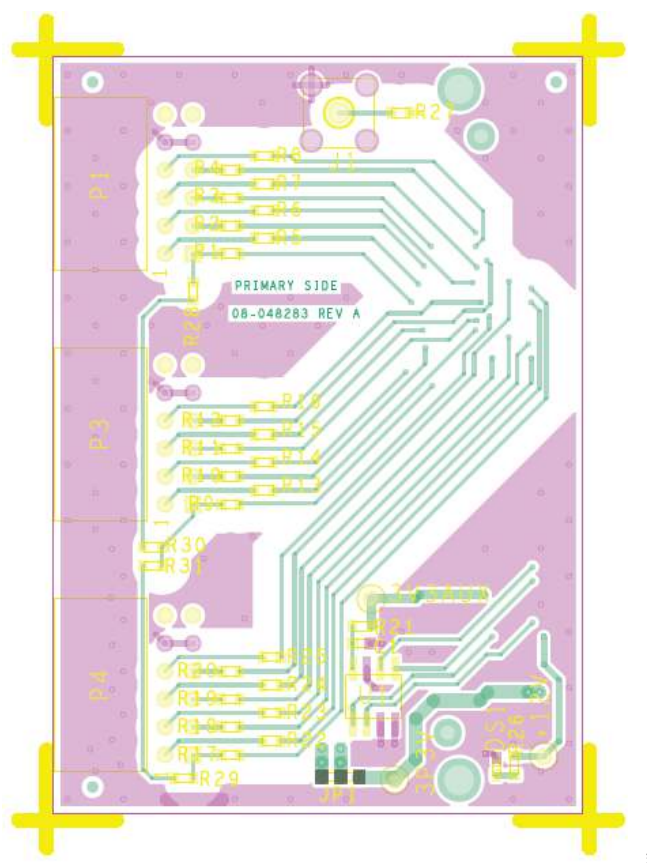

Figure 33. EVAL-PMD-IB1Z, Top Layer

EVALUATION BOARD SCHEMATICS AND SILKSCREENS

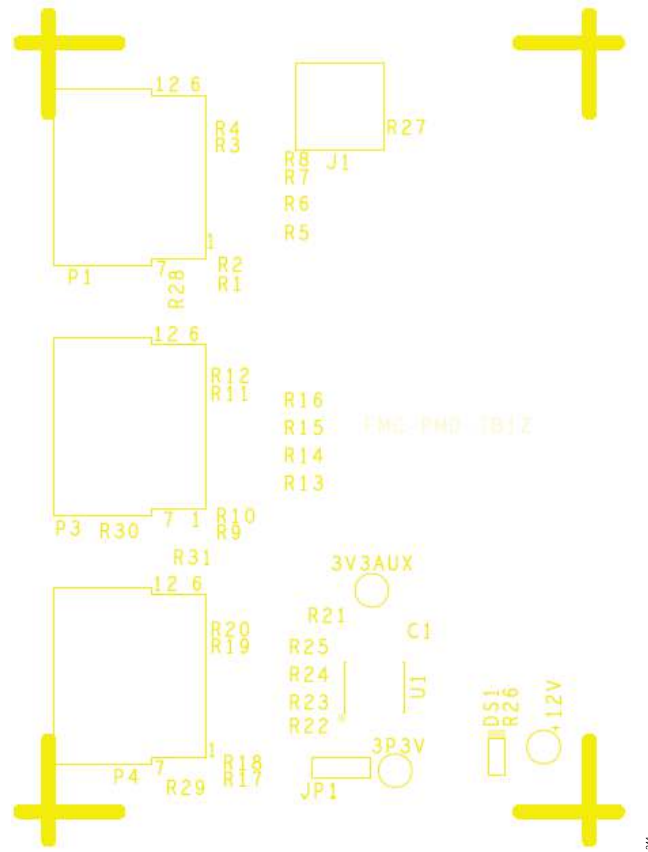

Figure 34. EVAL-PMD-IB1Z Silkscreen, Primary

EVALUATION BOARD SCHEMATICS AND SILKSCREENS

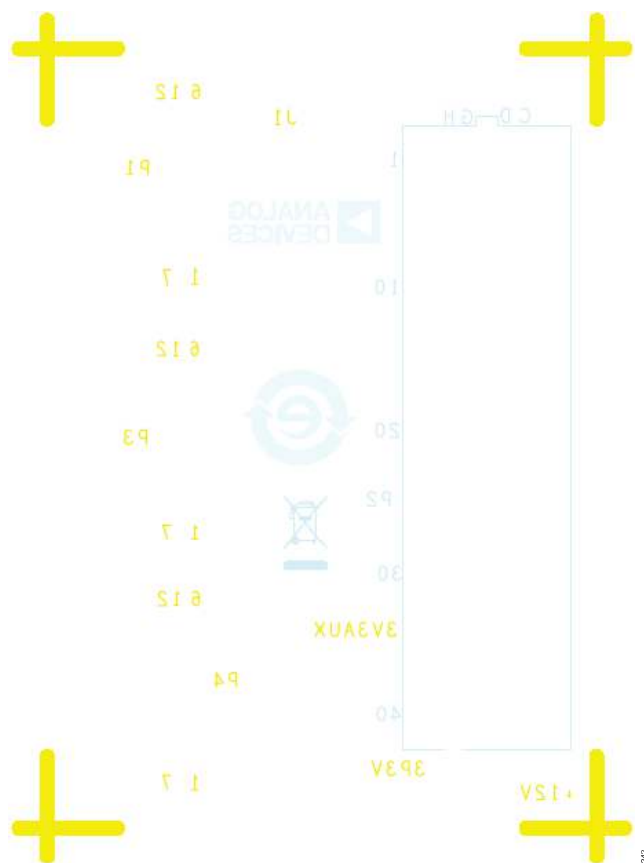

Figure 35. EVAL-PMD-IB1Z Silkscreen, Secondary

EVALUATION BOARD SCHEMATICS AND SILKSCREENS

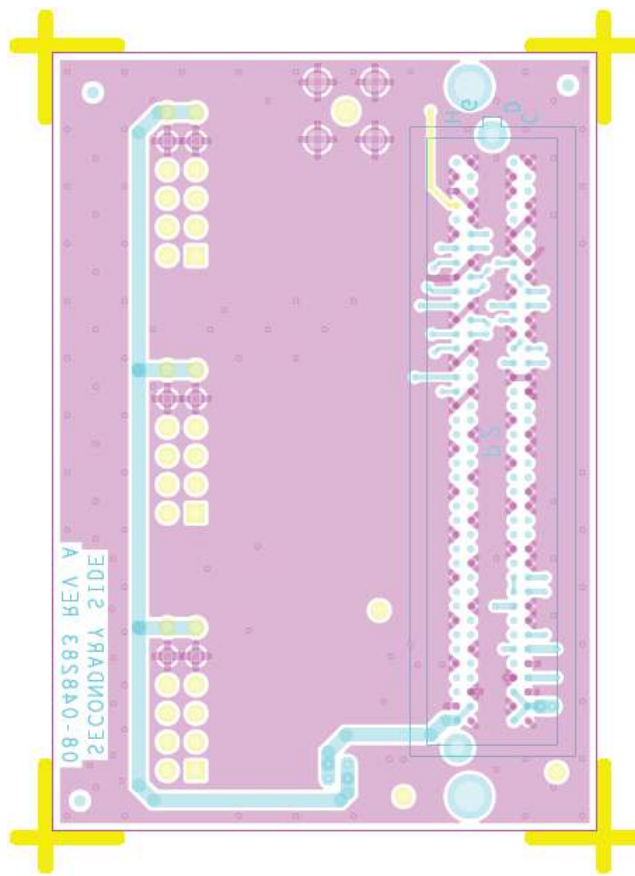

Figure 36. EVAL-PMD-IB1Z, Secondary

ORDERING INFORMATION

BILL OF MATERIALS

Table 4. EVAL-ADAQ4001PMDZ and EVAL-ADAQ4003PMDZ Bill of Materials

Qty.	Reference Designator	Description	Manufacturing	Part No.
5	+15.5 V, -15.5 V, -VS, GND, VIN	Connector printed circuit board (PCB) test points, white	Components Corporation	TP-104-01-09
2	C1, C7	22 μ F ceramic capacitors, X5R, general-purpose	Murata	GRM188R61A226ME15D
1	C10	0.022 μ F ceramic capacitor, X7R, general-purpose	TDK Corporation	CGA2B3X7R1H223K
1	C11	0.039 μ F ceramic capacitor, X7R, 0402	AVX	0402ZC393JAT2A
2	C2, C12	1 μ F ceramic capacitors, X7R, general-purpose	Samsung	CL10B105KP8NNNC
4	C14, C15, C20, C21	10 μ F ceramic capacitors, X5R, general-purpose	Murata	GRM21BR61E106KA73L
4	C8, C16, C24, C25	4.7 μ F multilayer ceramic capacitors, X7R	TDK Corporation	C2012X7R1E475K125AB
2	C6, C18	0.1 μ F ceramic capacitors, X7R, 0603	AVX	06035C104KAT2A
4	C19, C23, C27, C28	0.01 μ F ceramic capacitors, X7R, general-purpose	KEMET	C0402C103J3RACTU
1	C4, C9	1 μ F ceramic capacitors, X7R, general-purpose	Murata	GCM21BR71E105KA56L
2	C5, C22	2.2 μ F ceramic capacitors, X5R, general-purpose	Murata	GRM188R61H225KE11J
1	C26	1 μ F ceramic capacitor, X7R, general-purpose	TDK Corporation	CGA3E1X7R1C105K080AC
2	C29, C30	2.2 μ F ceramic capacitors, X7R, general-purpose	Murata	GRM188R71A225KE15D
1	C3	10 μ F capacitor, 10%, 10 V, X7R, 0805	TDK Corporation	C2012X7R1A106K125AC
6	C39 to C44	0.1 μ F ceramic capacitors, X7R, general-purpose	AVX	04023C104KAT2A
2	C4, C9	4.7 μ F ceramic capacitors, X7R	Murata	GCM21BR71E105KA56L
1	C52	0.0033 μ F monolithic ceramic capacitor, 0402	Yageo	CC0402KRX7R9BB332
1	C53	0.0047 μ F ceramic capacitor, X7R, general-purpose	KEMET	C0402C472K5RACTU
2	D1, D2	Schottky diodes, barrier rectifier	Diodes, Inc.	DFLS240-7
2	E1, E2	Inductor ferrite beads, 0.150 Ω maximum dc resistance, 1 A	TDK Corporation	MPZ1608S601ATA00
2	J1, J2	0 Hz to 4 GHz, SMB connectors, 50 Ω , solder right angle thru-hole, gold over nickel	Cinch Connectivity Solutions	131-3701-301
2	L1, L2	22 μ H inductors, shielded power	Coilcraft, Inc.	LPS5030-223MRC
2	L4, L5	680 nH inductors, shielded power	Coilcraft, Inc.	PFL3215-681MEB
1	P1	Connector, unshrouded header, 12 position, 2.54 mm, solder right angle thru-hole, bulk	Samtec, Inc.	TSW-106-25-F-D-RA
1	R10	100 k Ω resistor, precision thick film chip	Panasonic	ERA-2AEB104X
1	R11	80.6 k Ω resistor, precision thick film chip	Panasonic	ERJ-2RKF8062X
1	R12	2.7 k Ω resistor, precision thick film chip	Panasonic	ERJ-2RKF2701X
1	R13	54.9 k Ω resistor, precision thick film chip	Panasonic	ERJ-2RKF5492X
2	R14, R15	11.5 Ω resistors, precision thick film chip	Panasonic	ERJ-2RKF11R5X

ORDERING INFORMATION

Table 4. EVAL-ADAQ4001PMDZ and EVAL-ADAQ4003PMDZ Bill of Materials

Qty.	Reference Designator	Description	Manufacturing	Part No.
1	R16	60.4 kΩ resistor, precision thick film chip	Panasonic	ERJ-2RKF6042X
3	R8, R17, R31	698 kΩ resistors, precision thick film chip	Panasonic	ERJ-2RKF6983X
2	R18, R21	61.9 kΩ resistors, precision thick film chip	Yageo	RC0402FR-0761K9L
4	R2 to R5	42.2 kΩ resistors, precision thick film chip	Panasonic	ERJ-2RKF4222X
5	R6, R20, R22, R24, R25	0 Ω film resistors, surface-mount device (SMD), 0603	Panasonic	ERJ-3GEY0R00V
24	R7, R23, R26 to R30, R35 to R37, R40, R43 to R48, R51 to R55, R57, R60	0 Ω film resistors, SMD, 0402, jumper short	Panasonic	ERJ-2GE0R00X
2	R32, R34	200 kΩ resistors, precision thick film chip	Panasonic	ERJ-2RKF2003X
1	R33	95.3 kΩ resistor, precision thick film chip	Panasonic	ERJ-2RKF9532X
1	R9	3.3 kΩ resistor, precision thick film chip	Panasonic	ERJ-2RKF3301X
1	RN1	Resistor network quad matched	Analog Devices, Inc.	LT5400BHMS8E-4#PBF
1	U1	Ultralow noise, high accuracy, 5.0 V voltage reference	Analog Devices	ADR4550BRZ
1	U2	Dual positive and negative low noise low dropout (LDO) regulator	Analog Devices	LT3032IDE#PBF
1	U3	1 A/0.6 A, dc-to-dc switching regulator with independent positive and negative outputs	Analog Devices	ADP5070ACPZ-R7
2	U4, U7	High voltage, low noise, low distortion, unity-gain stable, high speed op amps	Analog Devices	ADA4898-1YRDZ
1	U5	16-bit/18-bit, 2 MSPS, μModule data acquisition solution in ball grid array	Analog Devices	ADAQ4001/ADAQ4003
1	U6	Low dropout, low noise regulator	Analog Devices	LT3023IDD#PBF
1	A1	Programmable gain drift instrument amplifier	Analog Devices	AD8251ARMZ

ORDERING INFORMATION

Table 5. EVAL-PMD-IB1Z Bill of Materials

Qty	Reference Designator	Description	Manufacturing	Part No.
3	+12 V, 3P3V, 3V3AUX	Connector PCB test points, red	Keystone Electronics	5000
1	C1	0.1 µF ceramic capacitor, X7R	AVX	06035C104KAT2A
1	DS1	LED, green, clear	Fairchild	QTLP600C4TR
1	J1	Connector, PCB, straight, Subminiature Version A (SMA)	TE Connectivity Ltd	5-1814832-1
3	P1 to P3	Connector headers, female, 12 position, right angle, gold, 2.54 mm pitch	Sullins	PPPC062LJBN-RC
1	P2	FMA connector, single-ended array, male, 160 position	Samtec	ASP-134604-01
25	R1 to R25, R59	0 Ω film resistors, SMD, 0603	Panasonic	ERJ-2RKF2003X
1	R26	2.4 kΩ resistor, precision thick film chip	Panasonic	ERJ-2RKF2R4X
1	U1	2 Kb serial I ² C bus electronically erasable programmable read-only memory (EEPROM)	ST Microelectronics	M24C02-WMN6TP

I²C refers to a communications protocol originally developed by Philips Semiconductors (now NXP Semiconductors).



ESD Caution

ESD (electrostatic discharge) sensitive device. Charged devices and circuit boards can discharge without detection. Although this product features patented or proprietary protection circuitry, damage may occur on devices subjected to high energy ESD. Therefore, proper ESD precautions should be taken to avoid performance degradation or loss of functionality.

Legal Terms and Conditions

By using the evaluation board discussed herein (together with any tools, components documentation or support materials, the "Evaluation Board"), you are agreeing to be bound by the terms and conditions set forth below ("Agreement") unless you have purchased the Evaluation Board, in which case the Analog Devices Standard Terms and Conditions of Sale shall govern. Do not use the Evaluation Board until you have read and agreed to the Agreement. Your use of the Evaluation Board shall signify your acceptance of the Agreement. This Agreement is made by and between you ("Customer") and Analog Devices, Inc. ("ADI"), with its principal place of business at Subject to the terms and conditions of the Agreement, ADI hereby grants to Customer a free, limited, personal, temporary, non-exclusive, non-sublicensable, non-transferable license to use the Evaluation Board FOR EVALUATION PURPOSES ONLY. Customer understands and agrees that the Evaluation Board is provided for the sole and exclusive purpose referenced above, and agrees not to use the Evaluation Board for any other purpose. Furthermore, the license granted is expressly made subject to the following additional limitations: Customer shall not (i) rent, lease, display, sell, transfer, assign, sublicense, or distribute the Evaluation Board; and (ii) permit any Third Party to access the Evaluation Board. As used herein, the term "Third Party" includes any entity other than ADI, Customer, their employees, affiliates and in-house consultants. The Evaluation Board is NOT sold to Customer; all rights not expressly granted herein, including ownership of the Evaluation Board, are reserved by ADI. CONFIDENTIALITY. This Agreement and the Evaluation Board shall all be considered the confidential and proprietary information of ADI. Customer may not disclose or transfer any portion of the Evaluation Board to any other party for any reason. Upon discontinuation of use of the Evaluation Board or termination of this Agreement, Customer agrees to promptly return the Evaluation Board to ADI. ADDITIONAL RESTRICTIONS. Customer may not disassemble, decompile or reverse engineer chips on the Evaluation Board. Customer shall inform ADI of any occurred damages or any modifications or alterations it makes to the Evaluation Board, including but not limited to soldering or any other activity that affects the material content of the Evaluation Board. Modifications to the Evaluation Board must comply with applicable law, including but not limited to the RoHS Directive. TERMINATION. ADI may terminate this Agreement at any time upon giving written notice to Customer. Customer agrees to return to ADI the Evaluation Board at that time. LIMITATION OF LIABILITY. THE EVALUATION BOARD PROVIDED HEREUNDER IS PROVIDED "AS IS" AND ADI MAKES NO WARRANTIES OR REPRESENTATIONS OF ANY KIND WITH RESPECT TO IT. ADI SPECIFICALLY DISCLAIMS ANY REPRESENTATIONS, ENDORSEMENTS, GUARANTEES, OR WARRANTIES, EXPRESS OR IMPLIED, RELATED TO THE EVALUATION BOARD INCLUDING, BUT NOT LIMITED TO, THE IMPLIED WARRANTY OF MERCHANTABILITY, TITLE, FITNESS FOR A PARTICULAR PURPOSE OR NON-INFRINGEMENT OF INTELLECTUAL PROPERTY RIGHTS. IN NO EVENT WILL ADI AND ITS LICENSORS BE LIABLE FOR ANY INCIDENTAL, SPECIAL, INDIRECT, OR CONSEQUENTIAL DAMAGES RESULTING FROM CUSTOMER'S POSSESSION OR USE OF THE EVALUATION BOARD, INCLUDING BUT NOT LIMITED TO LOST PROFITS, DELAY COSTS, LABOR COSTS OR LOSS OF GOODWILL. ADI'S TOTAL LIABILITY FROM ANY AND ALL CAUSES SHALL BE LIMITED TO THE AMOUNT OF ONE HUNDRED US DOLLARS (\$100.00). EXPORT. Customer agrees that it will not directly or indirectly export the Evaluation Board to another country, and that it will comply with all applicable United States federal laws and regulations relating to exports. GOVERNING LAW. This Agreement shall be governed by and construed in accordance with the substantive laws of the Commonwealth of Massachusetts (excluding conflict of law rules). Any legal action regarding this Agreement will be heard in the state or federal courts having jurisdiction in Suffolk County, Massachusetts, and Customer hereby submits to the personal jurisdiction and venue of such courts. The United Nations Convention on Contracts for the International Sale of Goods shall not apply to this Agreement and is expressly disclaimed.

