



Product Brief 2011

Power Capacitors

MKK-DC / MKK-DCI (-H) / MKK-DC-R

Characteristics and properties

High performance gas-impregnated capacitors offered for applications with medium voltage from 1500 to 3000 V DC and medium currents, with clear advantages in terms of lightness and reduced cost.

Oil-impregnated capacitors are alternatives when applications demand high operating temperature and currents, resulting in critical heating that is more effectively evacuated by oil. This technology in oil is also more suitable for applications with high nominal voltages of >1800 V DC and/or high ripple voltages above 400 V RMS. Polyurethane resin-filled capacitors are offered in low voltage

applications with high currents due to their more simple construction with less components. The resin acts as insulator and heat conductor.

In those cases where due to constraints in the application, the design of choice as explained above is not advisable or appropriate, a special custom-made design with another technology is possible.

Applications

- DC-voltage applications for DC link
- Resonant filtering
- Frequency converters

Housing

- Rectangular non-magnetic stainless steel case
- Ferric steel, aluminum

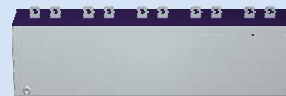

Power Capacitors

Overview		
MKK-DC B25650	MKK-DCI / MKK-DCI-H B25750	MKK-DC-R B25640
<ul style="list-style-type: none"> • Dry (gas) • SF6, N2 • Flat winding 	<ul style="list-style-type: none"> • Oil • Rapeseed oil • Flat winding 	<ul style="list-style-type: none"> • Dry • Polyurethane resin • Flat winding
Applications		
<ul style="list-style-type: none"> • < 3000 V DC • No AC ripple • Low temperature • DC link traction • State-of-the-art 	<ul style="list-style-type: none"> • 1800 ... 6500 V DC • With AC ripple • Better thermal stability • Filter circuit 	<ul style="list-style-type: none"> • 800 ... 1500 V DC • No AC ripple • Low temperature • DC link industrial • Best cost

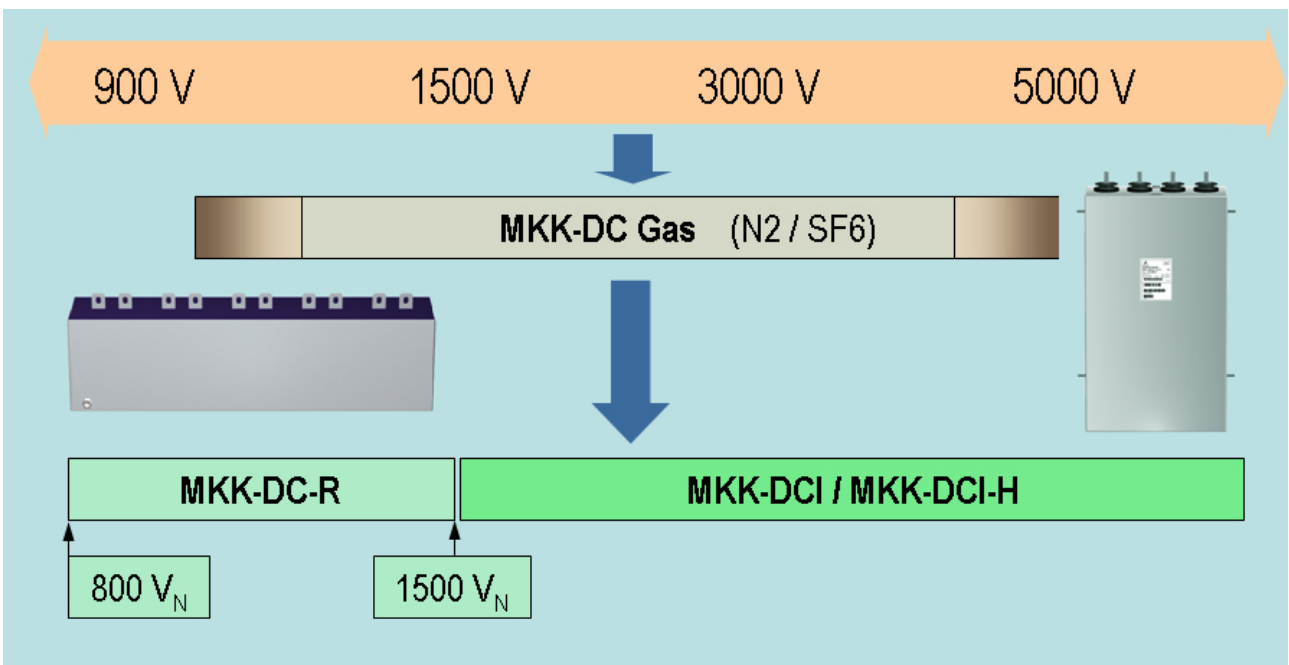

Specification and electrical characteristics	
Capacitance	100 ... 20 000 μ F
Tolerance	\pm 10%
Rated voltage	800 ... 6500 V DC
Operating hot-spot temperature	-55 ... +85 $^{\circ}$ C
Lifetime at V_R and +70 $^{\circ}$ C hot-spot temperature	Up to 350 000 h
Stray inductance	Minimum values of down to 30 nH
Impregnation	Resin, gas and oil available
Test voltage between terminals	$1.5 \cdot V_R$ during 10 s
Test voltage between shorten-terminals and case	$(2 \cdot V_R + 1000) V_{RMS}$ at 50 Hz during 60 s

Power Capacitors

MKK-DC/MKK-DCI/MKK-DCI-H: Mechanical considerations and construction

General description

The MKK-DC/MKK-DCI/MKK-DCI-H capacitors are designed in rectangular cases made of austenitic stainless steel. The cases are hermetically welded and the surface is not painted. Fixing brackets and bolts are mounted to fix the capacitor. Bolts are used also for the ground connection.

Different types of terminals are available for the terminal connections.

The capacitors should be exclusively handled by the fixing brackets. In no case the terminals should be used to lift the capacitor.

Capacitors will usually be mounted upright (terminals on top), but can be mounted in any position keeping a distance of 25 mm minimum between large facets, to allow for thermal expansion and effective cooling.

Standard design

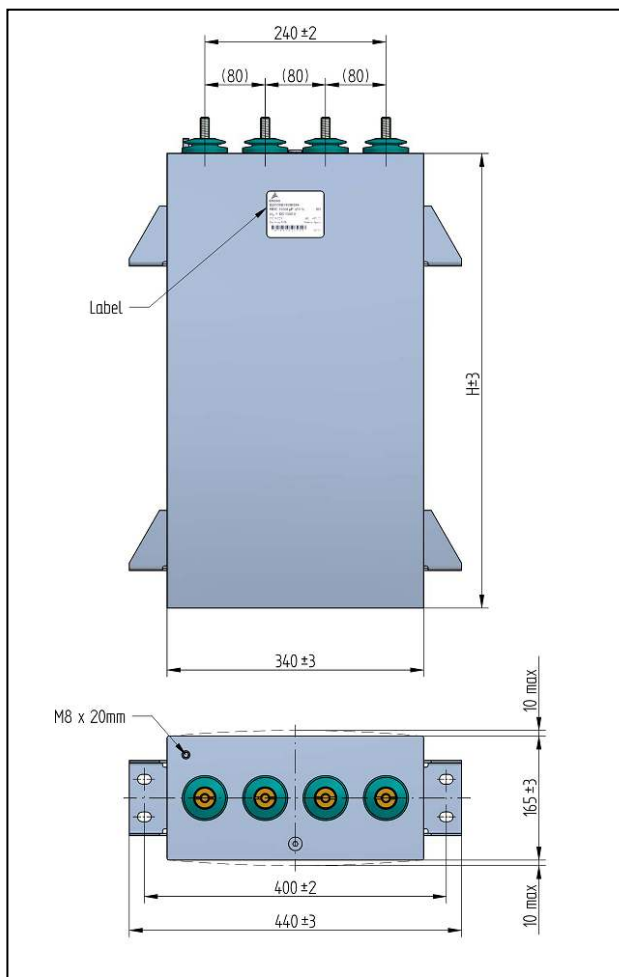

Dimensions

The following table shows the available standard dimensions. Deviations from these dimensions are available upon request.

Tolerances are indicated in the drawings as well as the maximum thermal expansions during normal operation conditions.

The label is located centered to the length and 50 mm from the top of the case.

Labeling: manufacturer (company logo), ordering code, connection diagram, version, rated capacitance, tolerance, weight, insulating voltage, IEC standard, country of origin, month/year of manufacturing.

	H1 mm	H2 mm	H3 mm
MKK-DC	340	605	805
MKK-DCI	340	605	
MKK-DCI-H	340	605	

Terminals and connections

Standard terminals are available as shown below.

Brass bolts, tinned, with different metrics in male and possibility of female connection, are available upon request.

Insulation material of the terminal is Epoxy according to CTI 600.

The following table shows the maximum continuous currents acceptable (for a temperature increase in the terminals of $+15$ °C), the maximum torque and the contact surface of standard terminals.

Other specific options are available upon request.

Please contact our local sales office.

Terminal M16	
Max. current	265 A
Max. torque	25 Nm
Contact surface	505 mm ²

Power Capacitors

Standard terminals

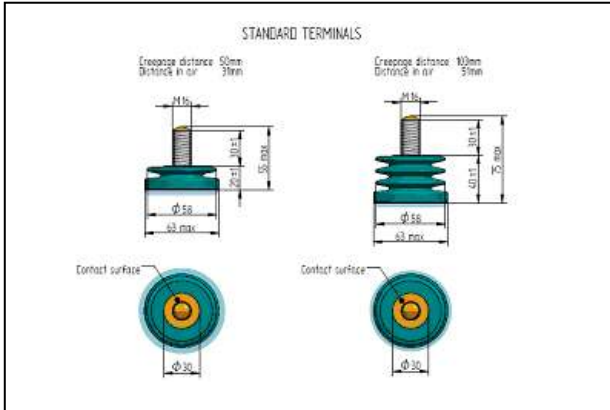

Fixing brackets

The standard fixing brackets of the cases are shown in the drawing below. For heights lower than 500 mm, the lower brackets are removed.

Upon request it is possible to substitute the fixing brackets by bolts (only for heights lower than 500 mm).

Other specific options are available upon request. Please contact our local sales office.

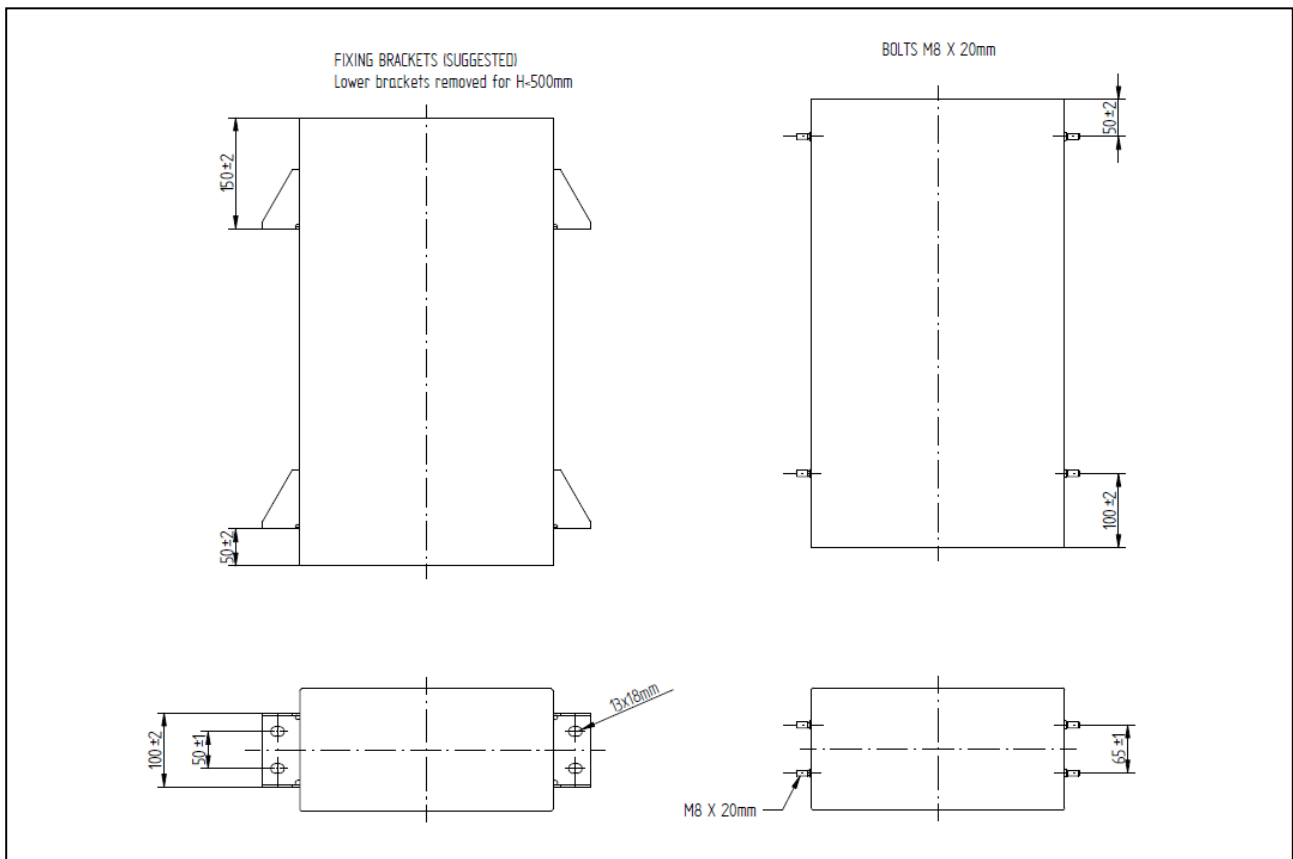
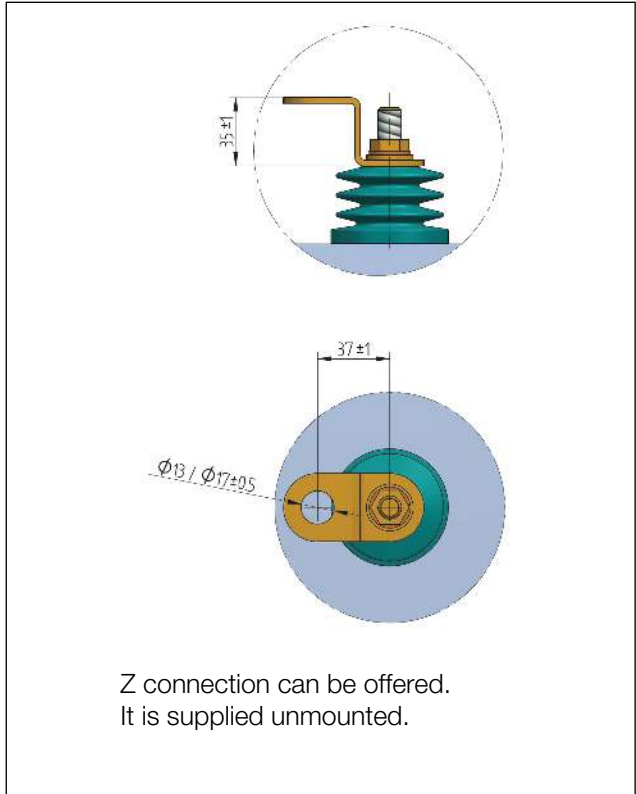

Power Capacitors

MKK-DC-R: Mechanical considerations and construction

General description

The MKK-DC-R capacitors are designed in aluminum rectangular cases filled with resin.

Fixing brackets are available as shown below. For any other options, please contact our local sales office.

The standard connection terminals are shown in the drawing below. Otherwise brass bolts tinned with male and possibility of female connection are available upon request.

The capacitors should be exclusively handled by fixing brackets. In no case, the terminals should be used to lift the capacitor.

Capacitors will usually be mounted upright (terminals on top), but can be mounted in any position keeping a lateral space of 25 mm minimum.

Dimensions

The table below shows the L dimension options and their relation to maximum current and number of terminal recommendable for low inductance option (inductance < 50 nH). Other dimensions are available on request.

Tolerances are indicated in the drawing.

Position of terminals (dimensions A and B) are changeable according to custom needs.

	L1 mm	L2 mm	L3 mm
MKK-DC-R	340	510	750

Inductance < 50 nH	Number of terminals	$I_{eff(max)}$ A
L1	6	210
L2	8	270
L3	10	350

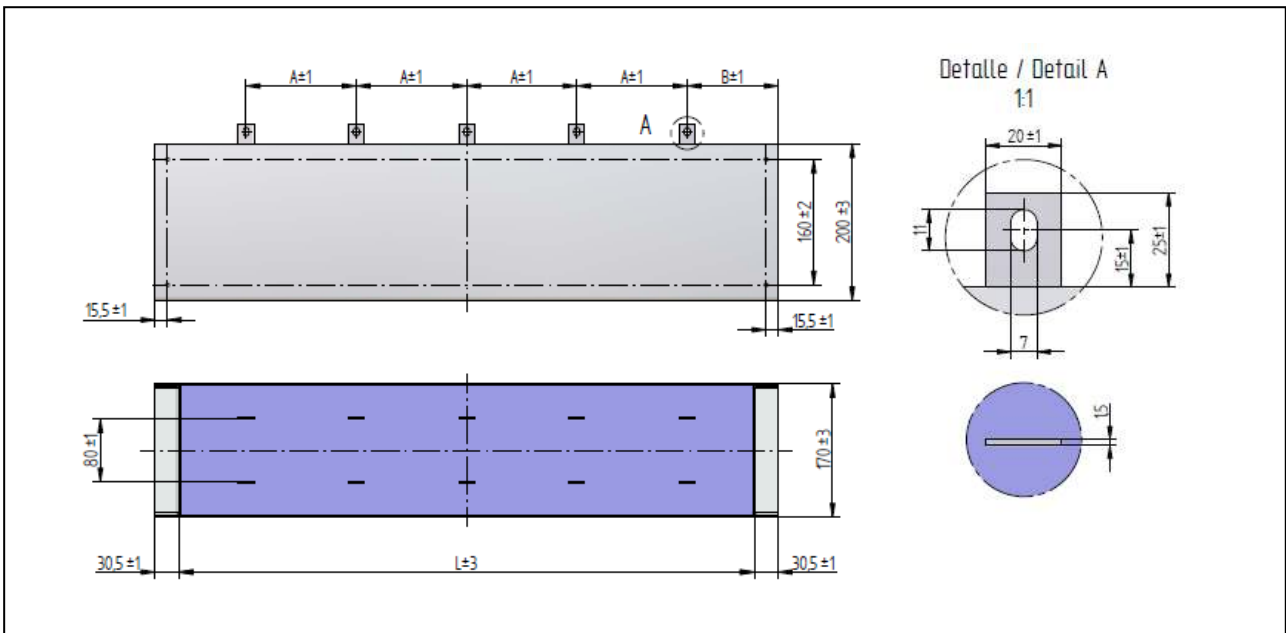

Power Capacitors

Technical data example: B25650D1528K004

Technical data		
Characteristics		
C_R	5200	μF
Tolerance	± 10	%
V_R	1800	V DC
V_i	1300	V AC
W_N	8420	Ws
$I_{\text{eff, max}}$	300	A
$I_{\text{eff, permanent}}$	216	A
L_R	49	nH
$\tan\delta_o$	2	10^{-4}
ESR	0.5	$\text{m}\Omega$
Maximum ratings		
\hat{V}	2200	V
V_R	2700	V
\hat{I}	36	kA
\hat{I}_s	312	kA
dv/dt_{max}	7	$\text{V}/\mu\text{s}$
dv/dt_s	60	$\text{V}/\mu\text{s}$
Test data		
$V_{\text{TT DC}}$	2700	$\text{V}@10 \text{ s}$
$V_{\text{TT AC}}$	3600	$\text{V}@ 50 \text{ Hz}, 60 \text{ s}$
$R_{\text{is XC}}$	≥ 2.78	h
$\tan\delta_{(120 \text{ Hz})}$	≤ 17	10^{-4}
Climatic conditions		
T_{min}	-50	$^{\circ}\text{C}$
$T_{\text{amb, max}}$	+60	$^{\circ}\text{C}$
$T_{\text{Hotspot, max}}$	+85	$^{\circ}\text{C}$
Humidity (av. rel.)	< 95	%
Failure rate	300	fit
Estimated lifetime	100 000	h
T_{storage}	-50 ... +85	$^{\circ}\text{C}$

Technical data		
Climatic category (DIN IEC 68 part 1 and 2)		
V_{test}	+40	$^{\circ}\text{C}$
Rel. humidity	93	%
t_{test}	56	days
$\Delta C/C$	≤ 1	%
$\Delta \tan\delta$	≤ 1	10^{-4}
$R_{\text{is XC}}$	10000	s
Design data		
Dimensions		
L_{case}	340	mm
B_{case}	162	mm
H_{case}	605	mm
A_{terminal}	80	mm
Terminations	M12 x 30	mm
Max. torque	20	Nm
Weight (approx.)	40	kg
Case extension ¹⁾	8	mm
Impregnation	gas filled	
Fixing elements	acc. spec.	
Remarks		
Project study		
Overpressure switch recommended		

1) with normal conditions

Power Capacitors

Ordering code system

	B25	650	D	2	108	K	00	4
Power capacitor, self healing								
Technology								
640 MKK-DC-R								
650 MKK-DC								
750 MKK-DCI and MKK-DCI-H								
Evolution number								
Rated voltage								
0 ≤ 1000 V								
1 ≥ 1000 V								
2 ≥ 2000 V								
3 ≥ 3000 V								
4 ≥ 4000 V								
5 ≥ 5000 V								
6 ≥ 6000 V								
Rated capacitance								
108 = 1000 μF = 10 x 10 ⁸ pF								
107 = 100 F = 10 x 10 ⁷ pF								
106 = 10 μF = 10 x 10 ⁶ pF								
105 = 1 μF = 10 x 10 ⁵ pF								
Tolerance								
K = ±10 %								
Code for capacitor version								
Terminals								
4 = screw								

KLK1859-4

MKK-DC series, all types with 4 terminals

C _R	V _R	I _{eff} @100Hz	V _s	dv/dt _s	ESR	Z _{th}	L _s	Ordering code
μF	V	A	V	V/μs	mW	°C/W	nH	
8200	900	240	1350	30	0.5	0.7	< 50	B25650C9828K004
6000	1100	230	1650	40	0.6	0.7	< 50	B25650D1608K024
2600	1800	175	2700	60	0.8	0.9	< 50	B25650D1268K004
900	3000	150	4500	220	0.9	0.9	< 50	B25650D3907K004
630	3600	130	5400	260	1.1	1.0	< 50	B25650D3637K004
510	4000	120	6000	290	1.3	1.0	< 50	B25650D4517K004
195	6000	75	9000	750	2.4	1.0	< 50	B25650D6197K004

Dimensions L x W x H: 340 x 165 x 340 mm, weight 24 kg

C _R	V _R	I _{eff} @100Hz	V _s	dv/dt _s	ESR	Z _{th}	L _s	Ordering code
μF	V	A	V	V/μs	mW	°C/W	nH	
16400	900	370	1350	30	0.4	0.3	< 80	B25650C9169K034
12000	1100	360	1650	40	0.4	0.3	< 80	B25650D1129K004
5200	1800	300	2700	60	0.5	0.4	< 80	B25650D1528K004*
1800	3000	275	4500	220	0.6	0.5	< 80	B25650D3188K024
1250	3600	240	5400	260	0.7	0.5	< 80	B25650D3128K004
1000	4000	220	6000	290	0.8	0.5	< 80	B25650D4108K004
390	6000	145	9000	750	1.3	0.7	< 80	B25650D6397K004

Dimensions L x W x H: 340 x 165 x 605 mm, weight 40 kg

*) see technical data on page 6

Power Capacitors

C_R μF	V_R V	I_{eff} @100Hz A	V_s V	dv/dt_s V/ μs	ESR mW	Z_{th} $^{\circ}\text{C/W}$	L_s nH	Ordering code
2500	3000	340	4500	220	0.5	0.3	< 100	B25650D3258K024
1700	3600	300	5400	260	0.6	0.3	< 100	B25650D3178K004
1400	4000	290	6000	290	0.7	0.3	< 100	B25650D4148K004

Dimensions L x W x H: 340 x 165 x 805 mm, weight 52 kg

MKK-DCI series, all types with 4 terminals

C_R μF	V_R V	I_{eff} @100Hz A	V_s V	dv/dt_s V/ μs	ESR mW	Z_{th} $^{\circ}\text{C/W}$	L_s nH	Ordering code
760	3500	170	5250	90	1.3	0.4	< 50	B25750D3767K004
610	3900	160	5850	100	1.5	0.4	< 50	B25750D3617K004
565	4100	160	6150	104	1.6	0.4	< 50	B25750D4567K004

Dimensions L x W x H: 340 x 165 x 340 mm, weight 26 kg

C_R μF	V_R V	I_{eff} @100Hz A	V_s V	dv/dt_s V/ μs	ESR mW	Z_{th} $^{\circ}\text{C/W}$	L_s nH	Ordering code
1500	3500	300	5250	90	0.6	0.3	< 80	B25750D3158K004
1200	3900	290	5850	100	0.6	0.3	< 80	B25750D3128K004
1100	4100	290	6150	104	0.6	0.3	< 80	B25750D4118K004

Dimensions L x W x H: 340 x 165 x 605 mm, weight 44 kg

MKK-DCI-H series, all types with 4 terminals

C_R μF	V_R V	I_{eff} @100Hz A	V_s V	dv/dt_s V/ μs	ESR mW	Z_{th} $^{\circ}\text{C/W}$	L_s nH	Ordering code
3400	1800	230	2700	50	0.7	0.4	< 50	B25750H1348K004
2700	2000	220	3000	60	0.7	0.4	< 50	B25750H2278K004
2200	2200	210	3300	65	0.7	0.4	< 50	B25750H2228K004
1500	2700	190	4000	80	0.9	0.4	< 50	B25750H2158K004
800	3600	220	5400	230	0.7	0.4	< 50	B25750H3807K004
500	4400	180	6600	280	0.9	0.4	< 50	B25750H4507K004
350	5400	160	8000	340	1.2	0.4	< 50	B25750H5357K004

Dimensions L x W x H: 340 x 165 x 340 mm, weight 30 kg

C_R μF	V_R V	I_{eff} @100Hz A	V_s V	dv/dt_s V/ μs	ESR mW	Z_{th} $^{\circ}\text{C/W}$	L_s nH	Ordering code
6900	1800	370	2700	55	0.5	0.3	< 80	B25750H1698K004
5400	2000	360	3000	60	0.5	0.3	< 80	B25750H2548K004
4400	2200	350	3300	65	0.5	0.3	< 80	B25750H2448K004
3000	2700	320	4000	80	0.6	0.3	< 80	B25750H2308K004

Dimensions L x W x H: 340 x 165 x 605 mm, weight 50 kg

Power Capacitors

MKK-DC-R series (terminal construction see page 5)

C_R μF	V_R V	I_{eff} @100Hz A	V_s V	dv/dt_s V/us	ESR mW	Z_{th} °C/W	L_s nH	Ordering code
5400	800	210	1200	30	0.7	0.6	< 50	B25640D8548K000
4300	900	200	1350	35	0.8	0.6	< 50	B25640D9438K000
3600	1000	190	1500	40	0.8	0.6	< 50	B25640D1368K000
3100	1100	190	1650	40	0.8	0.6	< 50	B25640D1318K000
2600	1200	180	1800	45	0.9	0.6	< 50	B25640D1268K000

Dimensions L x W x H: 340 x 170 x 200 mm, weight 18 kg

C_R μF	V_R V	I_{eff} @100Hz A	V_s V	dv/dt_s V/us	ESR mW	Z_{th} °C/W	L_s nH	Ordering code
8300	800	270	1200	30	0.5	0.5	< 50	B25640D8838K000
6700	900	260	1350	35	0.6	0.5	< 50	B25640D9678K000
5500	1000	260	1500	40	0.6	0.5	< 50	B25640D1558K000
4800	1100	250	1650	40	0.6	0.5	< 50	B25640D1488K000
4100	1200	240	1800	45	0.6	0.5	< 50	B25640D1418K000

Dimensions L x W x H: 510 x 170 x 200 mm, weight 26 kg

C_R μF	V_R V	I_{eff} @100Hz A	V_s V	dv/dt_s V/us	ESR mW	Z_{th} °C/W	L_s nH	Ordering code
12500	800	350	1200	30	0.5	0.4	< 50	B25640D8129K000
10100	900	350	1350	35	0.5	0.4	< 50	B25640D9109K000
8300	1000	340	1500	40	0.5	0.4	< 50	B25640D1838K000
7300	1100	340	1650	40	0.5	0.4	< 50	B25640D1738K000
6200	1200	330	1800	45	0.5	0.4	< 50	B25640D1628K000

Dimensions L x W x H: 750 x 170 x 200 mm, weight 32 kg

Lifetime

The end of life criterion is a capacitance loss higher than 3% compared to initial value.

Capacitor	Lifetime	Hotspot temperature
MKK-DC MKK-DC-R	100 000 h	+70 °C
MKK-DCI MKK-DCI-H	150 000 h	+75 °C

Important information: Some parts of this publication contain statements about the suitability of our products for certain areas of application. These statements are based on our knowledge of typical requirements that are often placed on our products. We expressly point out that these statements cannot be regarded as binding statements about the suitability of our products for a particular customer application. It is incumbent on the customer to check and decide whether a product is suitable for use in a particular application. This publication is only a brief product survey which may be changed from time to time. Our products are described in detail in our data sheets. The Important notes (www.epcos.com/ImportantNotes) and the product-specific Cautions and warnings must be observed. All relevant information is available through our sales offices.