

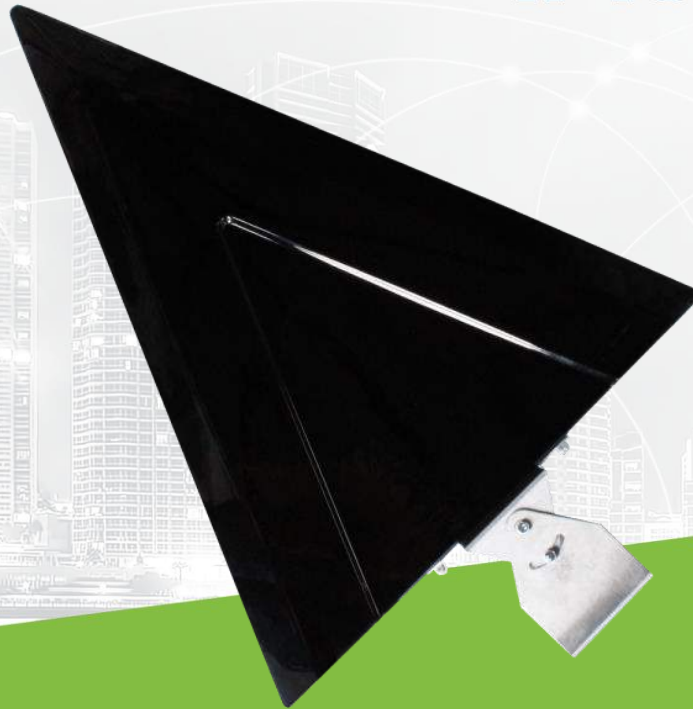

TAOGLAS®



Datasheet

Part No:
LPDA.05.032111

Description:
LPDA.05 Engager External Wide Band
Directional LPDA Antenna

Features:
Frequency: 600-6000MHz
Peak Gain: >6dBi 600-4000MHz, >2.5dBi 4000-6000Mhz
Dimensions: 520*630*42mm
Dimensions with bracket: 520*770*95mm
Cable Length: 300mm
Connector: SMA(M)
RoHS & Reach Compliant

1. Introduction	3
2. Specifications	4
3. Antenna Characteristics	6
4. Radiation Patterns	8
<hr/>	
Changelog	19

Taoglas makes no warranties based on the accuracy or completeness of the contents of this document and reserves the right to make changes to specifications and product descriptions at any time without notice. Taoglas reserves all rights to this document and the information contained herein. Reproduction, use or disclosure to third parties without express permission is strictly prohibited.



1. Introduction

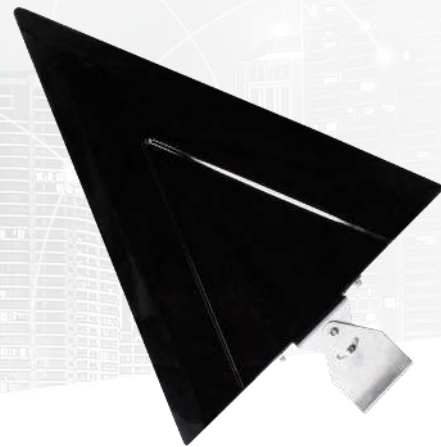

The LPDA.05.032111 is a wideband directional LPDA exterior antenna that operates within the 600-6000MHz frequency bands. It is an innovative and future proof solution ideal for 4G/5G and also 2G/3G networks as well as 2.4GHz and 5.8GHz Wi-Fi.

This wideband design eliminates the need to purchase different antennas for each frequency, in turn simplifying installations since the same antenna can be used for a wide array of wireless applications when wide coverage is desired.

The LPDA.05 has a 70° beam width in both orthogonal planes. The ABS external housing is robust, UV resistant and waterproof IP65 rated. For various mounting options, it is supplied with tilt and swivel wall and pole brackets. The LPDA.05 has been tested for wind resistance up 200 km/h.

5G/4G and 2.4GHz and 5.8GHz Wi-Fi applications demand high speed data uplink and downlink and where required, two LPDA.05 antennas can be mounted in space at 90° to create a MIMO arrangement.

Cable type, length and connectors are customizable for large order volumes. Please contact your regional Taoglas Customer support Team for more information.

2. Specifications

Electrical								
Band	Frequency (MHz)	Efficiency (%)	Average Gain (dB)	Peak Gain (dBi)	Impedance	Max Input Power	Polarization	Radiation Patterns
5GNR/4G Band 71	617~698	61	-2.2	7.5	50Ω	10W	Linear	Directional
4G/3G Band 12,13,14,17,28,29	698~806	54	-2.7	7.4				
4G/3G/NB-IoT/Cat M Band 5,8,18,19,20,26,27	824~960	55	-2.6	7.4				
5GNR/4G Band 21,32,74,75,76	1427~1518	65	-1.8	8.3				
4G/3G Band 1,2,3,4,9,23,25,35,39,66	1710~2200	56	-2.5	8.3				
4G/3G Band 7,30,38,40,41	2300~2690	56	-2.6	8.0				
5GNR/4G Band 22,42,48,77,78,79	3300~4200	45	-3.4	7.9				
LTE5200/ Wi-Fi 5800	5150~5925	32	-5.0	6.1				
Mechanical								
Dimensions	520mm X 630mm X 42mm Without Bracket 520mm X 770mm X 95mm With Bracket							
Material	Body: PC Coated UV Stabilized ABS Bracket: Black Powder Coated 316 Stainless							
Connector	SMA(M)							
Weight	819g With Bracket 430g Without Bracket							
Cable Type	300mm RG-174							
IP Rating	IP65							
Environmental								
Operation Temperature	-40°C to 85°C							
Storage Temperature	-40°C to 105°C							
Humidity	Non-condensing 65°C 95% RH							
Wind Resistance	Up to 200km/h							

5G/4G Bands			
Band Number	5G NR / FR1 / LTE / LTE-Advanced / WCDMA / HSPA / HSPA+ / TD-SCDMA		
	Uplink	Downlink	Covered
1	UL: 1920 to 1980	DL: 2110 to 2170	✓
2	UL: 1850 to 1910	DL: 1930 to 1990	✓
3	UL: 1710 to 1785	DL: 1805 to 1880	✓
4	UL: 1710 to 1755	DL: 2110 to 2155	✓
5	UL: 824 to 849	DL: 869 to 894	✓
7	UL: 2500 to 2570	DL: 2620 to 2690	✓
8	UL: 880 to 915	DL: 925 to 960	✓
9	UL: 1749.9 to 1784.9	DL: 1844.9 to 1879.9	✓
11	UL: 1427.9 to 1447.9	DL: 1475.9 to 1495.9	✓
12	UL: 699 to 716	DL: 729 to 746	✓
13	UL: 777 to 787	DL: 746 to 756	✓
14	UL: 788 to 798	DL: 758 to 768	✓
17	UL: 704 to 716	DL: 734 to 746	✓
18	UL: 815 to 830	DL: 860 to 875	✓
19	UL: 830 to 845	DL: 875 to 890	✓
20	UL: 832 to 862	DL: 791 to 821	✓
21	UL: 1447.9 to 1462.9	DL: 1495.9 to 1510.9	✓
22	UL: 3410 to 3490	DL: 3510 to 3590	✓
23	UL: 2000 to 2020	DL: 2180 to 2200	✓
24	UL: 1625.5 to 1660.5	DL: 1525 to 1559	✓
25	UL: 1850 to 1915	DL: 1930 to 1995	✓
26	UL: 814 to 849	DL: 859 to 894	✓
27	UL: 807 to 824	DL: 852 to 869	✓
28	UL: 703 to 748	DL: 758 to 803	✓
29	UL: -	DL: 717 to 728	✓
30	UL: 2305 to 2315	DL: 2350 to 2360	✓
31	UL: 452.5 to 457.5	DL: 462.5 to 467.5	✗
32	UL: -	DL: 1452 - 1496	✓
35		1850 to 1910	✓
38		2570 to 2620	✓
39		1880 to 1920	✓
40		2300 to 2400	✓
41		2496 to 2690	✓
42		3400 to 3600	✓
43		3600 to 3800	✓
48		3550 to 3700	✓
66	UL: 1710-1780	DL: 2110-2200	✓
71		617 to 698	✓
74/75/76		1427 to 1518	✓
78		3300 to 3800	✓
79		4400 to 5000	✓
85	698-716	728-746	✓

3. Antenna Characteristics

3.1 Return Loss

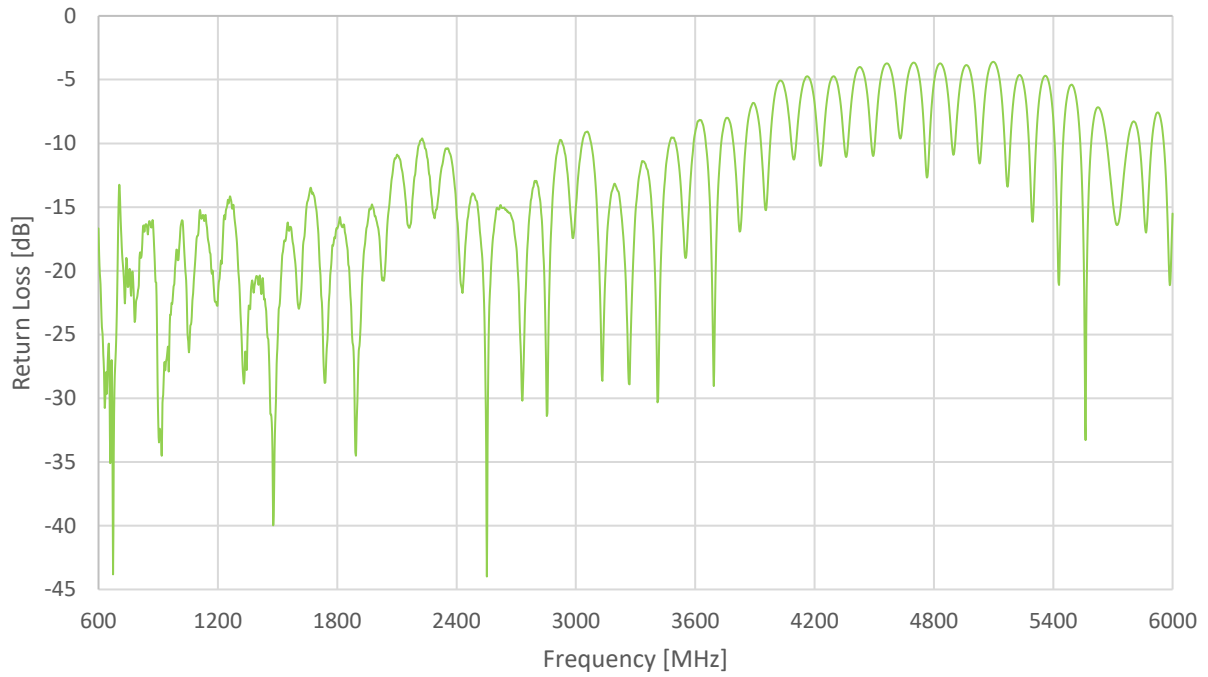

3.2 Efficiency

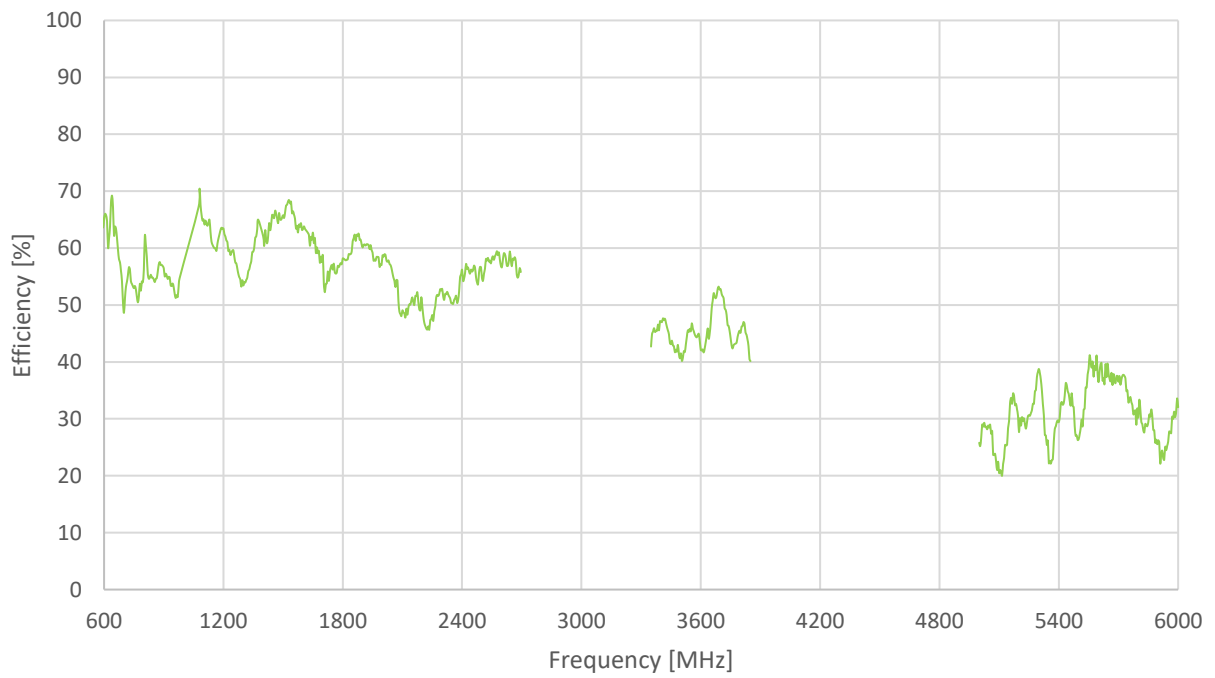

3.3 Average Gain

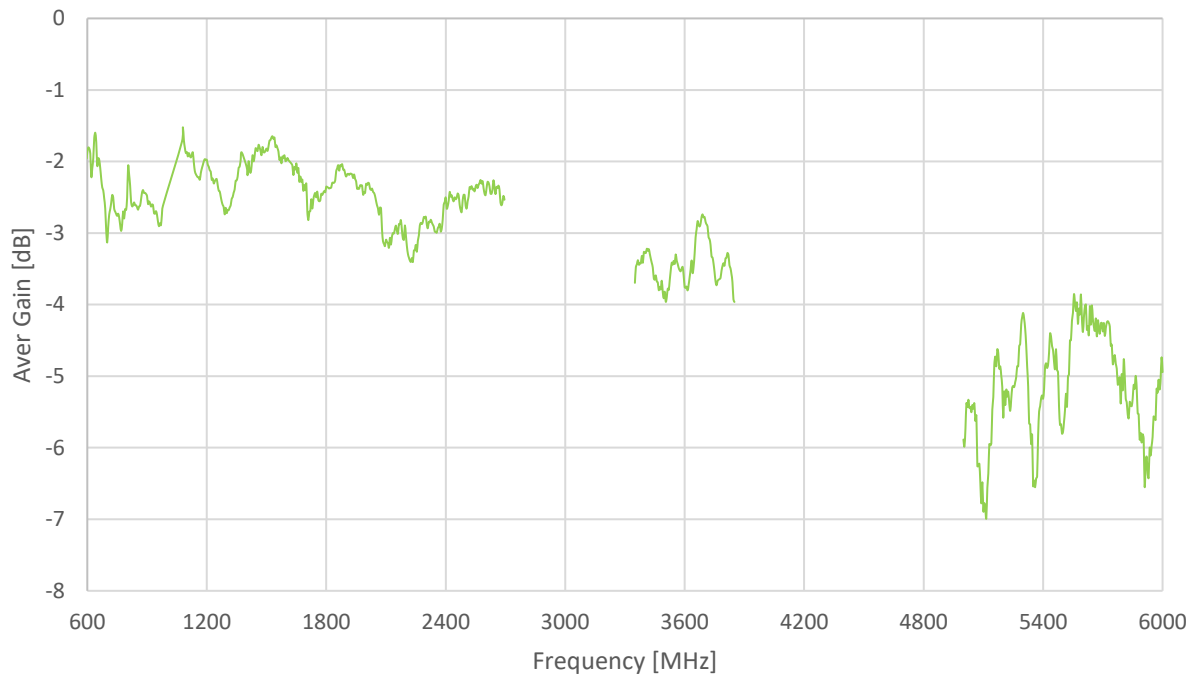

3.4 Peak Gain

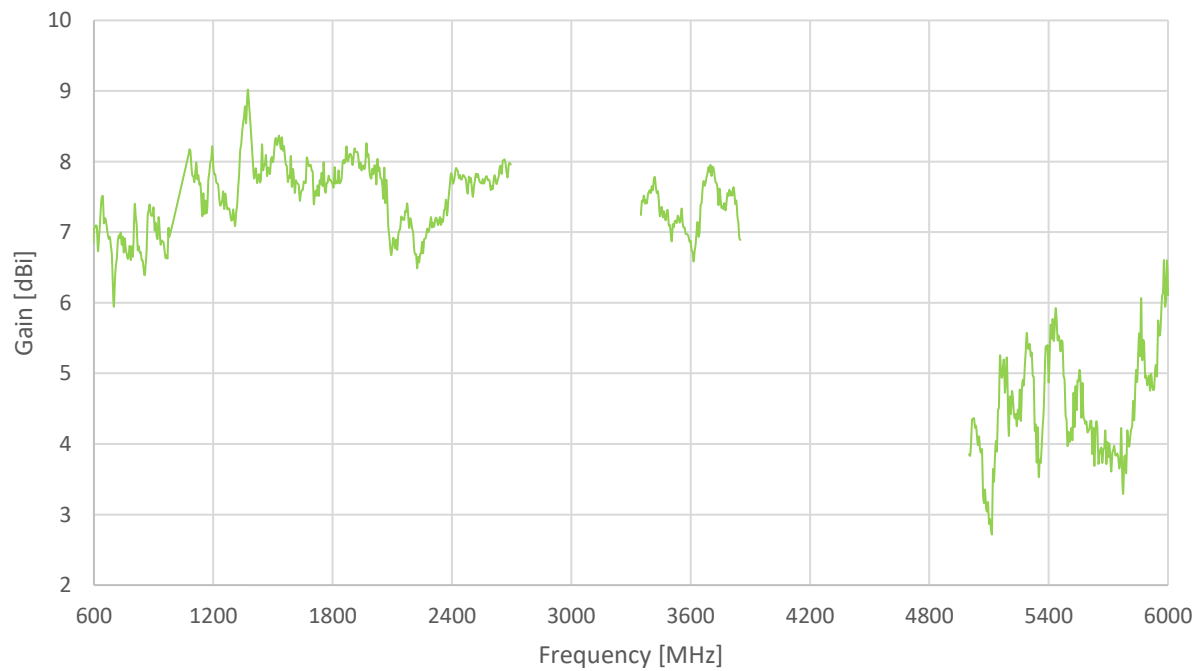

4. Radiation Patterns

4.4.1 Test Setup

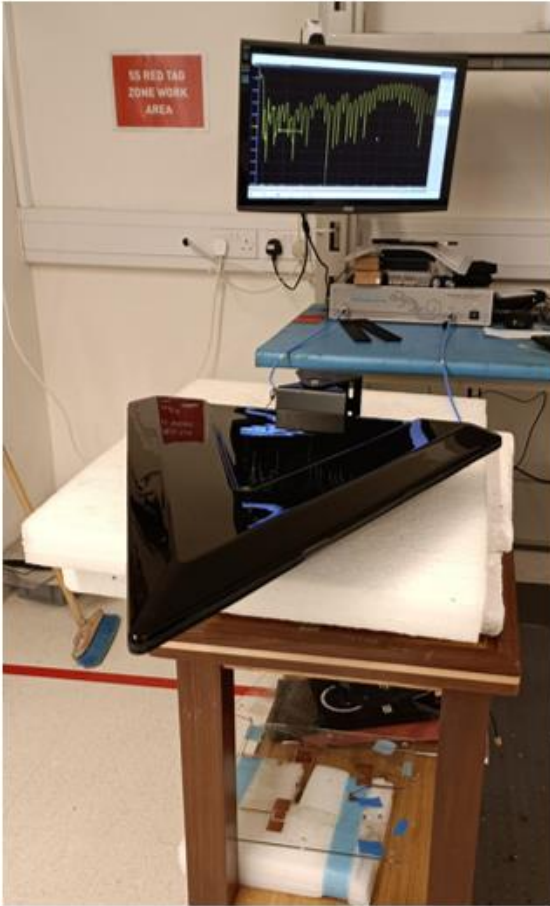

VNA Setup

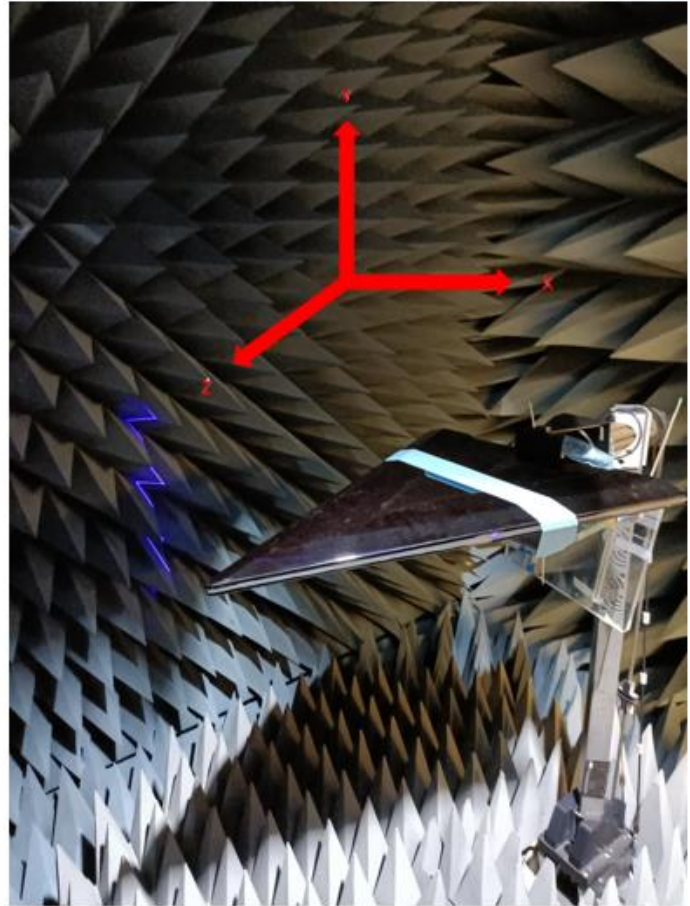

Anechoic Chamber Setup

4.2 615MHz 3D and 2D Radiation Patterns

Azimuth = 0.0
 Elevation = 0.0
 Roll = -35.0

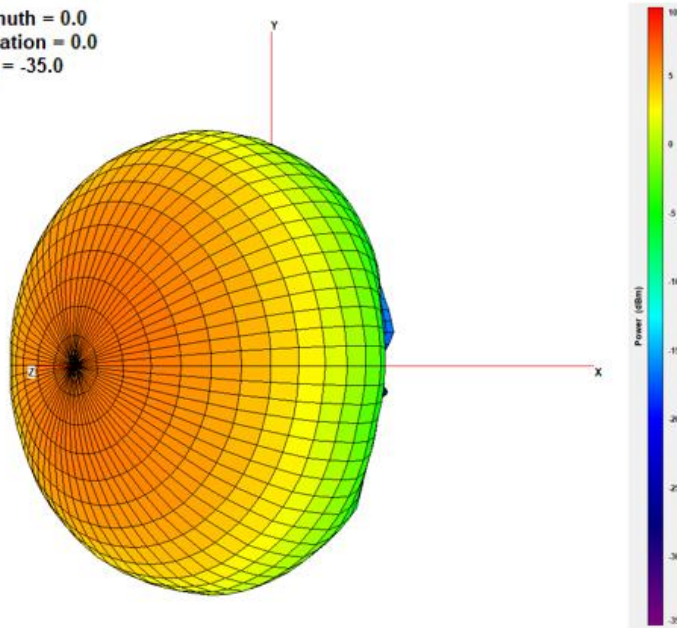

XY Plane

XZ Plane

YZ Plane

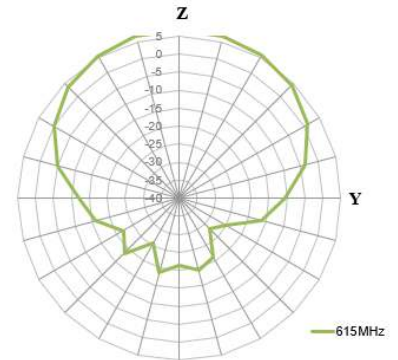
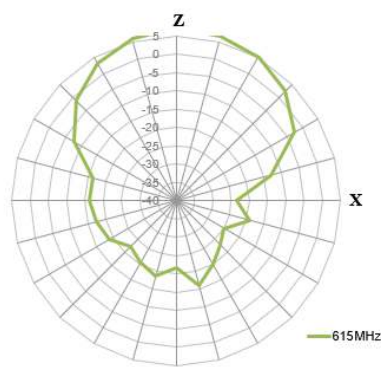
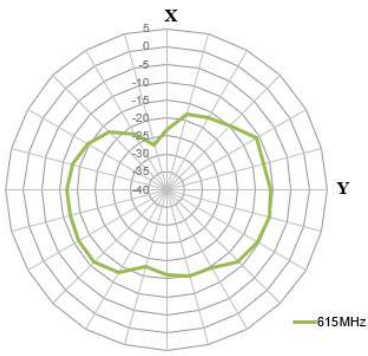

700MHz

Azimuth = 0.0
Elevation = 0.0
Roll = -35.0

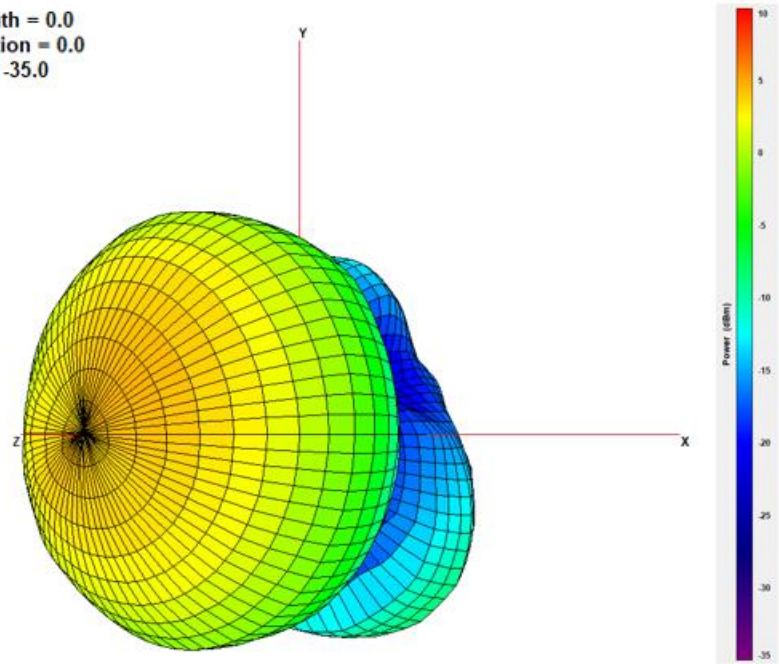

XY Plane

XZ Plane

YZ Plane

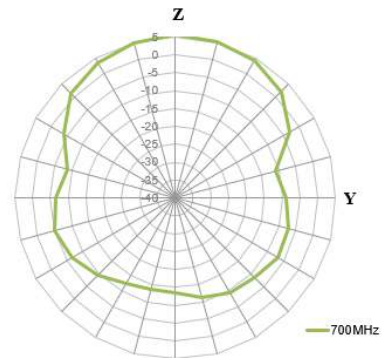
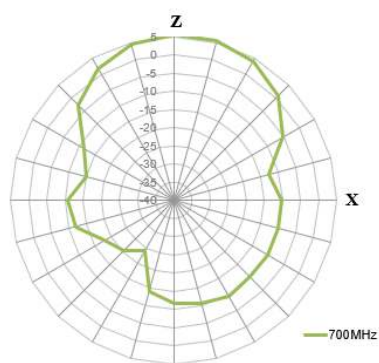
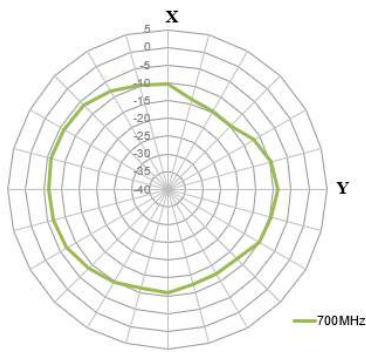

850MHz

Azimuth = 0.0
 Elevation = 0.0
 Roll = -35.0

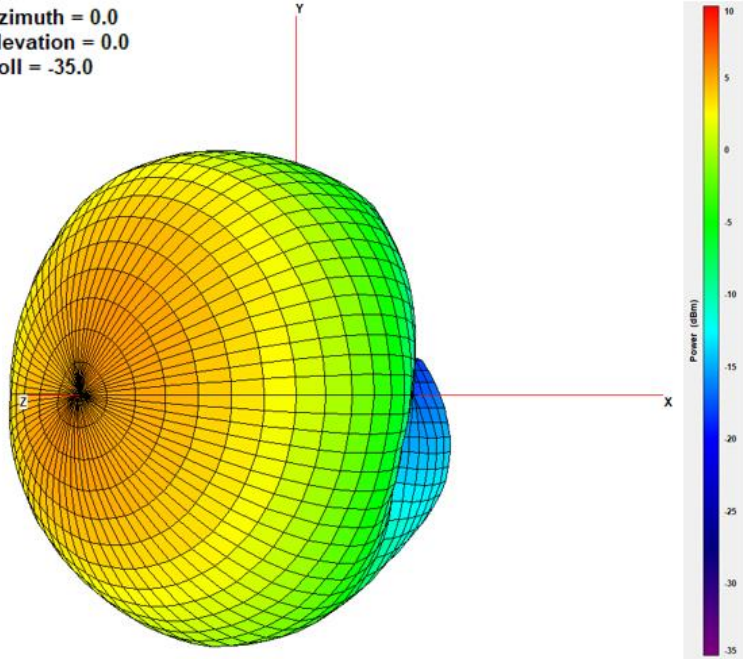

XY Plane

XZ Plane

YZ Plane

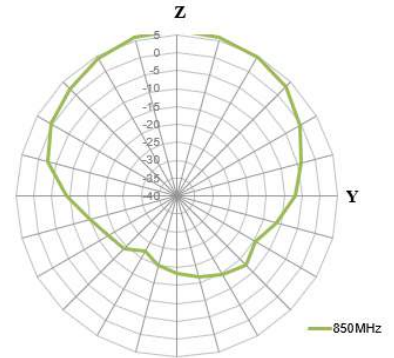
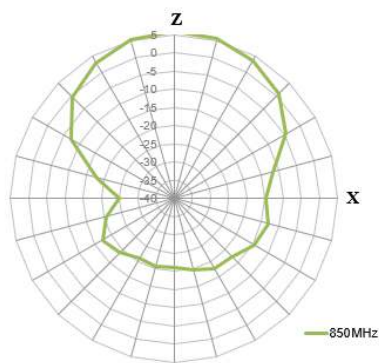
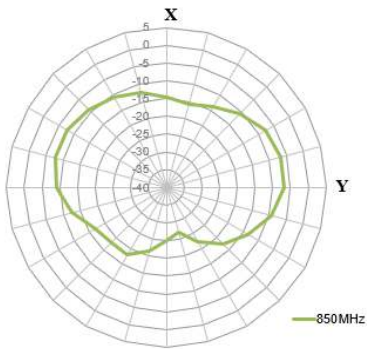

960MHz

Azimuth = 0.0
Elevation = 0.0
Roll = -35.0

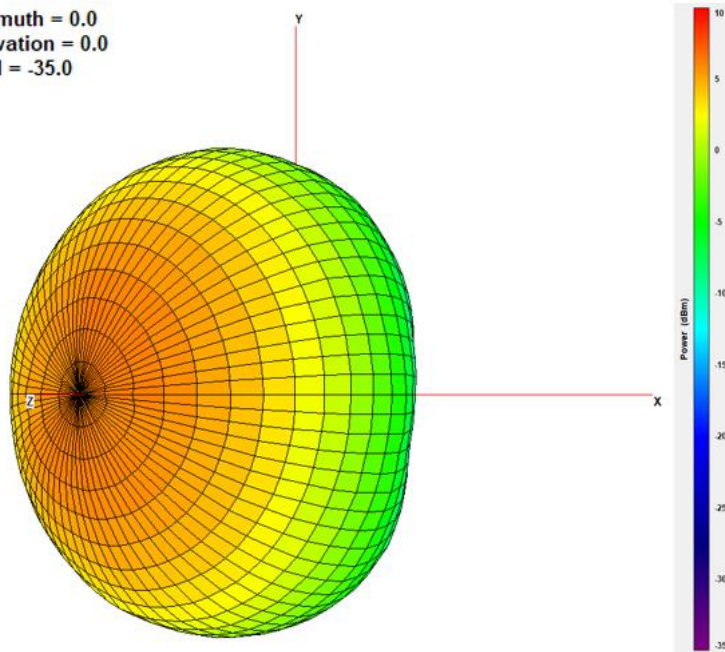

XY Plane

XZ Plane

YZ Plane

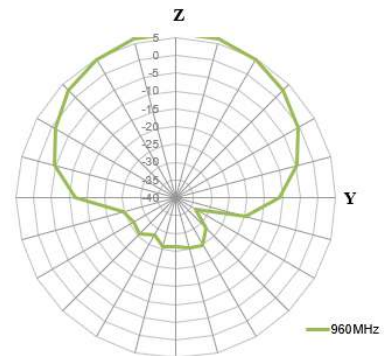
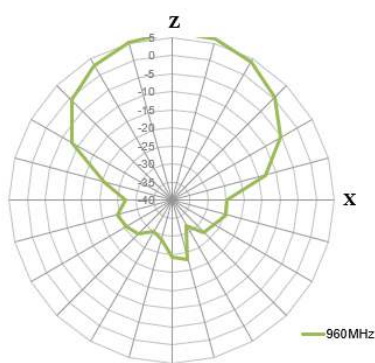
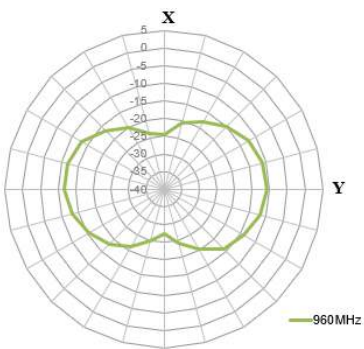

1710MHz

Azimuth = 0.0
 Elevation = 0.0
 Roll = -35.0

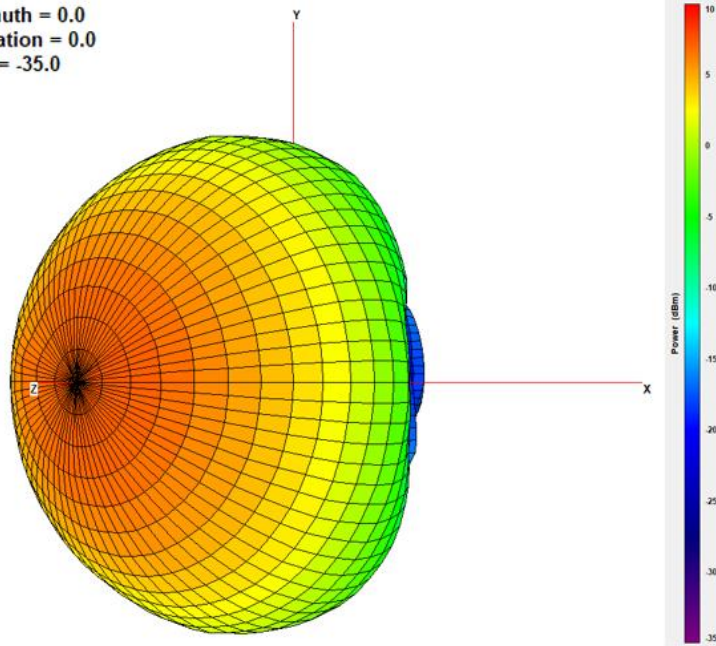

XY Plane

XZ Plane

YZ Plane

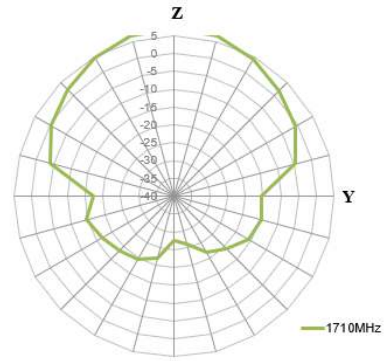
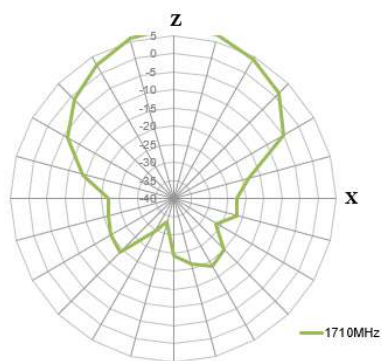
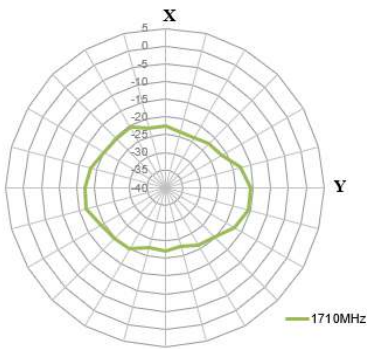

2150MHz

Azimuth = 0.0
Elevation = 0.0
Roll = -35.0

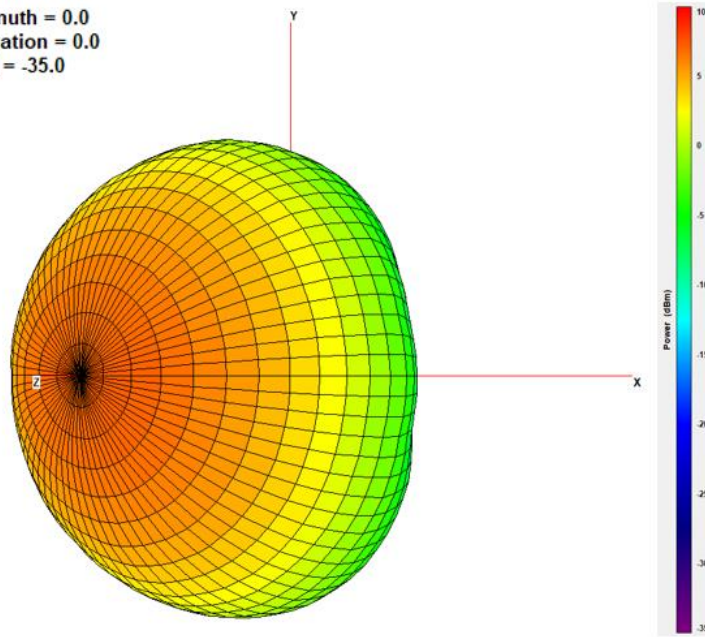

XY Plane

XZ Plane

YZ Plane

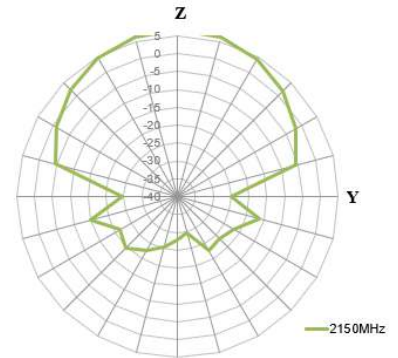
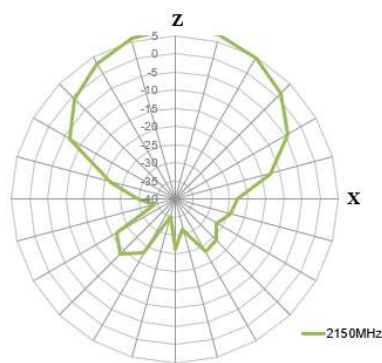
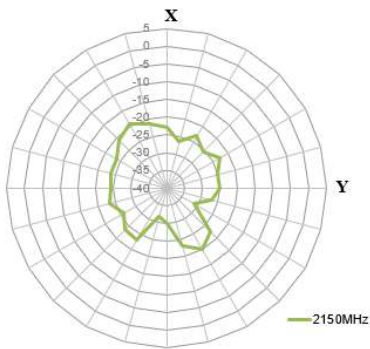

2690MHz

Azimuth = 0.0
 Elevation = 0.0
 Roll = -35.0

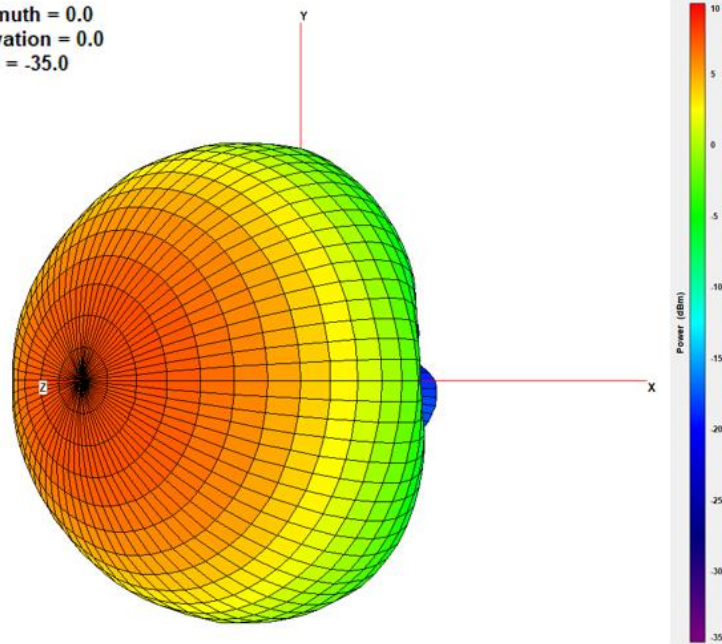

XY Plane

XZ Plane

YZ Plane

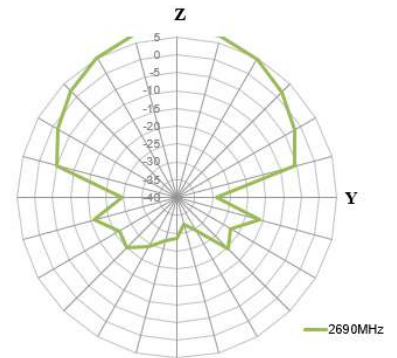
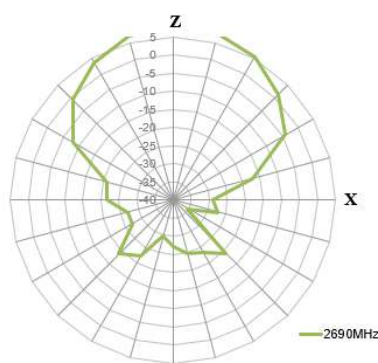
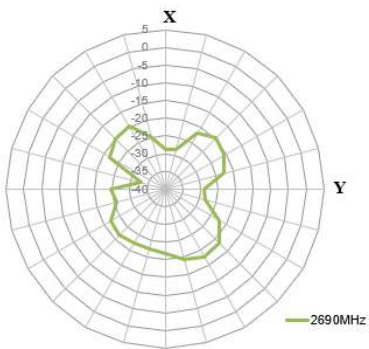

3500MHz

Azimuth = 0.0
 Elevation = 0.0
 Roll = -35.0

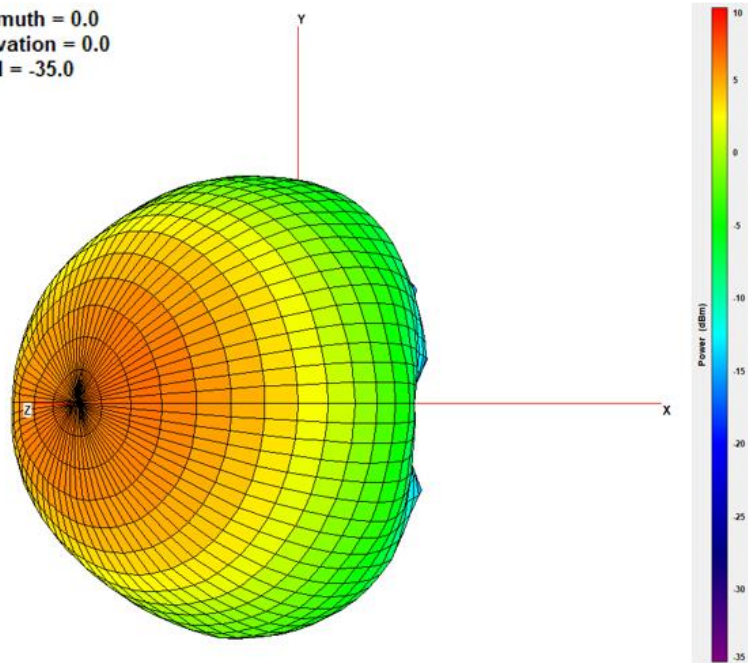

XY Plane

XZ Plane

YZ Plane

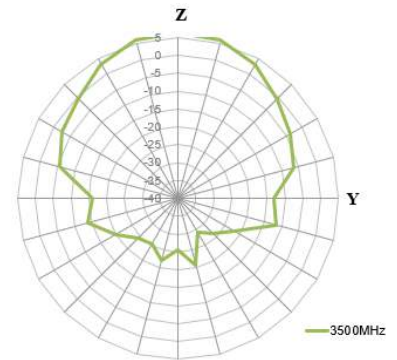
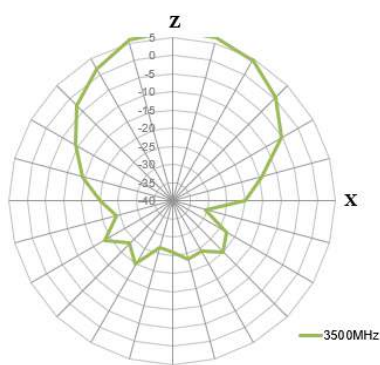
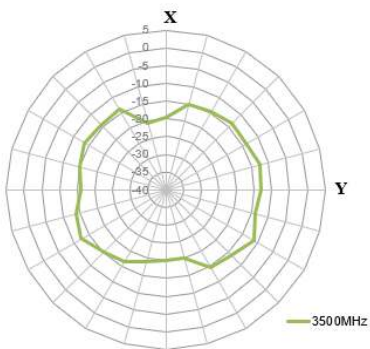

5150MHz

Azimuth = 0.0
 Elevation = 0.0
 Roll = -35.0

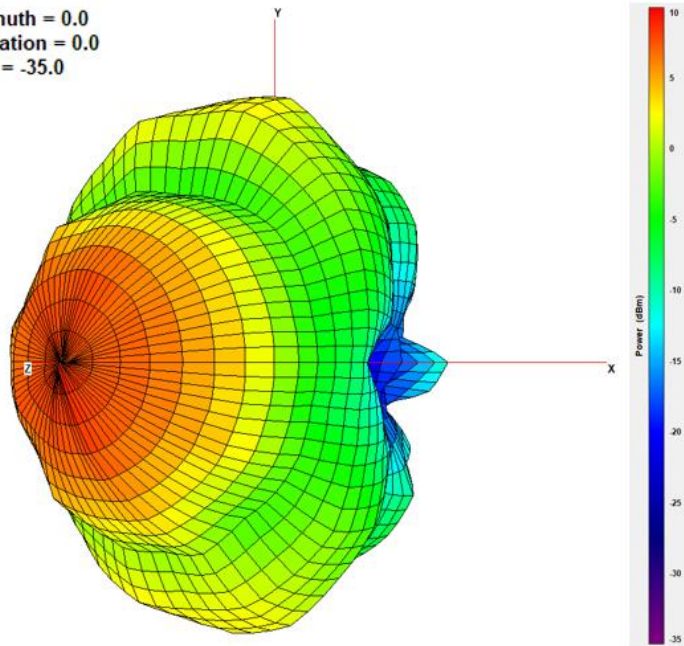

XY Plane

XZ Plane

YZ Plane

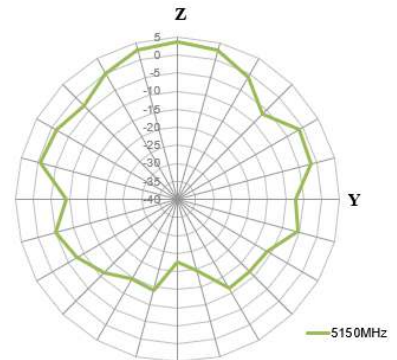
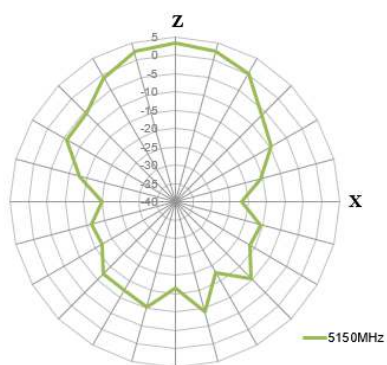
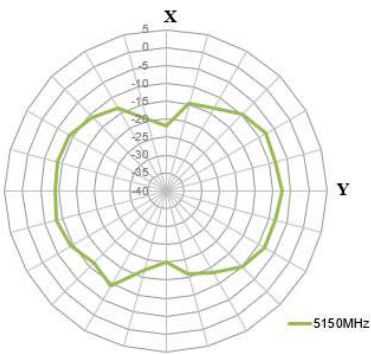

5550MHz

Azimuth = 0.0
Elevation = 0.0
Roll = -35.0

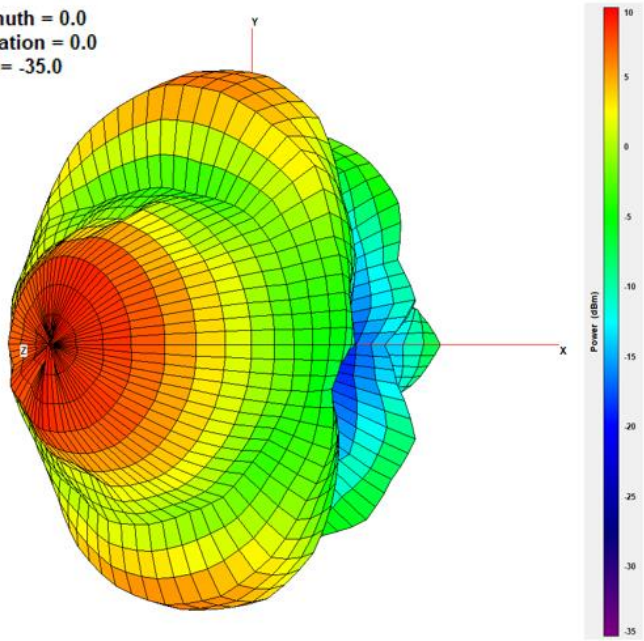

XY Plane

XZ Plane

YZ Plane

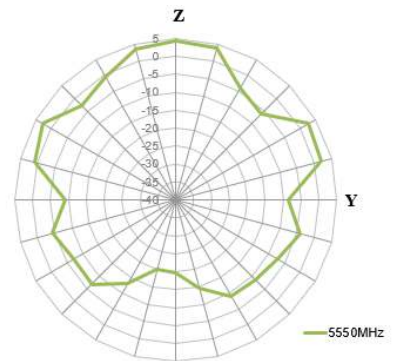
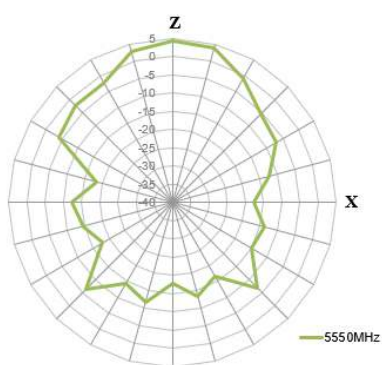
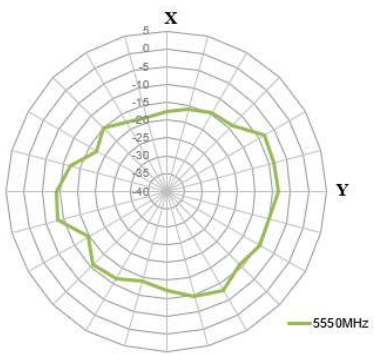

Changelog for the datasheet

SPE-19-8-098 – LPDA.05.032111

Revision: B (Current Version)	
Date:	2022-03-24
Changes:	Full datasheet template update
Changes Made by:	Gary West

Previous Revisions

Revision: A (Original First Release)	
Date:	2019-07-29
Notes:	
Author:	Technical Writer



TAOGLAS®

www.taoglas.com

