

DATA SHEET

TDA9801

Single standard VIF-PLL
demodulator and FM-PLL detector

Product specification
Supersedes data of 1998 May 06
File under Integrated Circuits, IC02

1999 Aug 26

Single standard VIF-PLL demodulator and FM-PLL detector

TDA9801

FEATURES

- Suitable for negative vision modulation
- Applicable for IF frequencies of 38.9, 45.75 and 58.75 MHz
- Gain controlled wide-band Vision Intermediate Frequency (VIF) amplifier (AC-coupled)
- True synchronous demodulation with active carrier regeneration (ultra-linear demodulation, good intermodulation figures, reduced harmonics and excellent pulse response)
- Peak sync pulse AGC
- Video amplifier to match sound trap and sound filter
- AGC output voltage for tuner with fixed resistor for takeover point setting
- AFC detector without extra reference circuit
- Alignment-free FM-PLL detector with high linearity

- Stabilizer circuit for ripple rejection and to achieve constant output signals
- 5 to 9 V positive supply voltage range
- Low power consumption of 300 mW at 5 V supply voltage.

GENERAL DESCRIPTION

The TDA9801(T) is a monolithic integrated circuit for vision and sound IF signal processing in TV and VTR sets and multimedia front-ends.

ORDERING INFORMATION

TYPE NUMBER	PACKAGE		
	NAME	DESCRIPTION	VERSION
TDA9801	DIP20	plastic dual in-line package; 20 leads (300 mil)	SOT146-1
TDA9801T	SO20	plastic small outline package; 20 leads; body width 7.5 mm	SOT163-1

Single standard VIF-PLL demodulator and FM-PLL detector

TDA9801

QUICK REFERENCE DATA

SYMBOL	PARAMETER	CONDITIONS	MIN.	TYP.	MAX.	UNIT
V_P	supply voltage	note 1	4.5	5.0	9.9	V
I_P	supply current	$V_P = 9\text{ V}$	52	61	70	mA
$V_{i(\text{sens})(\text{VIF})(\text{rms})}$	sensitivity of VIF input signal (RMS value)	-1 dB video at output; $f_{PC} = 38.9$ or 45.75 MHz	-	50	90	μV
$V_{i(\text{max})(\text{rms})}$	maximum input voltage (RMS value)	+1 dB video at output; $f_{PC} = 38.9$ or 45.75 MHz	70	150	-	mV
G_{IF}	IF gain control	$f_{PC} = 38.9$ or 45.75 MHz	64	70	-	dB
$V_{o(\text{CVBS})(\text{p-p})}$	CVBS output voltage (peak-to-peak value)	$V_P = 5\text{ V}$	1.7	2.0	2.3	V
$B_{V(-3\text{dB})}$	-3 dB video bandwidth	$C_L < 20\text{ pF}$; $R_L > 1\text{ k}\Omega$	6	8	-	MHz
S/N_W	weighted signal-to-noise ratio	$V_P = 5\text{ V}$; note 2	56	60	-	dB
$\alpha_{IM(0.92/1.1)}$	intermodulation attenuation at $f = 0.92$ or 1.1 MHz	for BLUE	56	62	-	dB
$\alpha_{IM(2.76/3.3)}$	intermodulation attenuation at $f = 2.76$ or 3.3 MHz	for BLUE	56	62	-	dB
$\alpha_{H(\text{sup})}$	harmonics suppression in video signal	note 3	35	40	-	dB
$V_{o(\text{AF})(\text{max})(\text{rms})}$	maximum output AF signal handling voltage (RMS value)	THD < 1.5%	0.8	-	-	V
T_{amb}	ambient temperature		-20	-	+70	$^{\circ}\text{C}$

Notes

1. Values of video and sound parameters can be decreased at $V_P = 4.5\text{ V}$.
2. S/N is the ratio of the black-to-white amplitude to the black level noise voltage (RMS value) at pin CVBS. $B = 5\text{ MHz}$ weighted in accordance with "CCIR 567" at a source impedance of $50\ \Omega$.
3. Measurements taken with SAW filter G1962; VSB modulation; $f_{\text{video}} > 0.5\text{ MHz}$; loop bandwidth $BL = 60\text{ kHz}$.

Single standard VIF-PLL demodulator and FM-PLL detector

TDA9801

BLOCK DIAGRAM

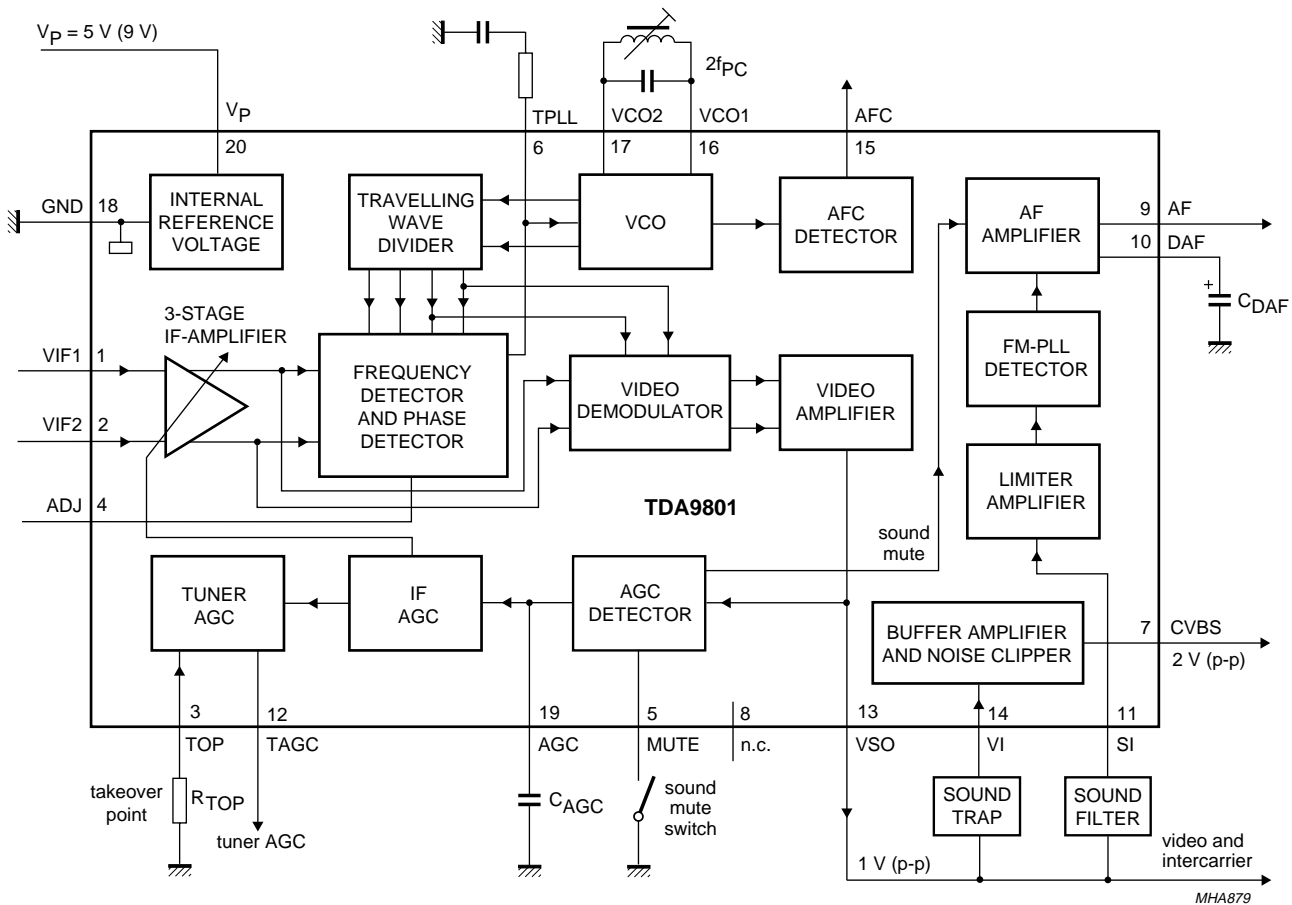

Fig.1 Block diagram.

MHA879

Single standard VIF-PLL demodulator and FM-PLL detector

TDA9801

PINNING

SYMBOL	PIN	DESCRIPTION
VIF1	1	VIF differential input 1
VIF2	2	VIF differential input 2
TOP	3	tuner AGC TakeOver Point (TOP) connection
ADJ	4	phase adjust connection
MUTE	5	sound mute switch connection
TPLL	6	PLL time constant connection
CVBS	7	CVBS (positive) video output
n.c.	8	not connected
AF	9	AF output
DAF	10	AF amplifier decoupling capacitor connection
SI	11	sound intercarrier input
TAGC	12	tuner AGC output
VSO	13	video and sound intercarrier output
VI	14	buffer amplifier video input
AFC	15	AFC output
VCO1	16	VCO1 reference circuit for $2f_{PC}$
VCO2	17	VCO2 reference circuit for $2f_{PC}$
GND	18	ground supply (0 V)
AGC	19	AGC detector capacitor connection
V _P	20	supply voltage (+5 V)

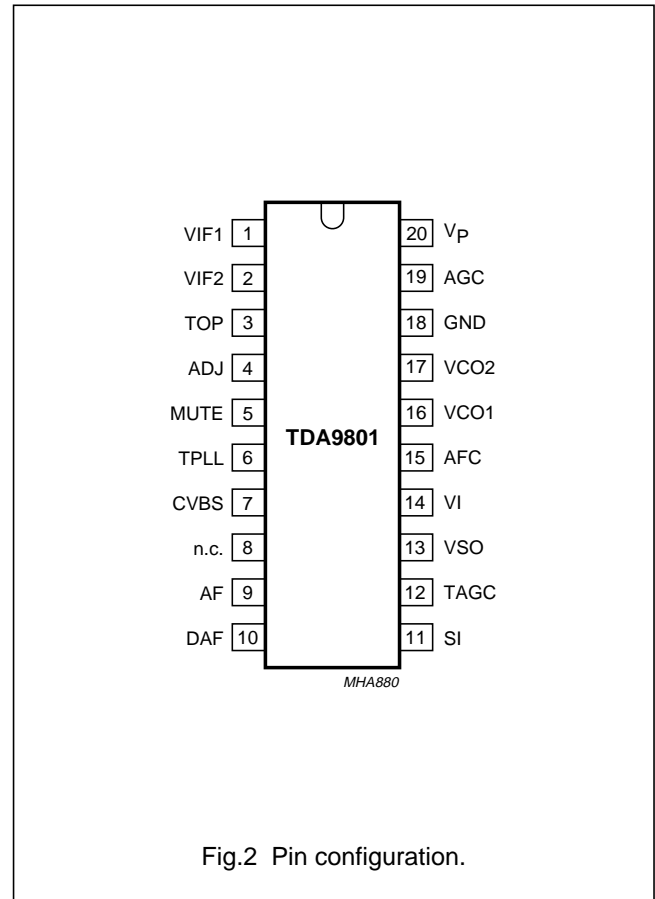

Single standard VIF-PLL demodulator and FM-PLL detector

TDA9801

FUNCTIONAL DESCRIPTION

3-stage IF amplifier

The VIF amplifier consists of three AC-coupled differential amplifier stages (see Fig.1). Each differential stage comprises a feedback network controlled by emitter degeneration.

AGC detector, IF AGC and tuner AGC

The automatic control voltage to maintain the video output signal at a constant level is generated in accordance with the transmission standard. Since the TDA9801(T) is suitable for negative modulation only the peak sync pulse level is detected.

The AGC detector charges and discharges capacitor C_{AGC} to set the IF amplifier and tuner gain. The voltage on capacitor C_{AGC} is transferred to an internal IF control signal, and is fed to the tuner AGC to generate the tuner AGC output current on pin TAGC (open-collector output). The tuner AGC takeover point level is set at pin TOP. This allows the tuner to be matched to the SAW filter in order to achieve the optimum IF input level.

Frequency detector and phase detector

The VIF amplifier output signal is fed into a frequency detector and into a phase detector. During acquisition the frequency detector produces a DC current proportional to the frequency difference between the input and the VCO signal. After frequency lock-in the phase detector produces a DC current proportional to the phase difference between the VCO and the input signal. The DC current of either frequency detector or phase detector is converted into a DC voltage via the loop filter which controls the VCO frequency.

Video demodulator

The true synchronous video demodulator is realized by a linear multiplier which is designed for low distortion and wide bandwidth. The vision IF input signal is multiplied with the 'in phase' component of the VCO output. The demodulator output signal is fed via an integrated low-pass filter ($f_g = 12$ MHz) for suppression of the carrier harmonics to the video amplifier.

VCO, AFC detector and travelling wave divider

The VCO operates with a symmetrically connected reference LC circuit, operating at the double vision carrier frequency. Frequency control is performed by an internal variable capacitor diode.

The voltage to set the VCO frequency to the actual double vision carrier frequency is also amplified and converted for the AFC output current.

The VCO signal is divided-by-2 with a Travelling Wave Divider (TWD) which generates two differential output signals with a 90 degree phase difference independent of the frequency.

Video amplifier

The composite video amplifier is a wide bandwidth operational amplifier with internal feedback. A nominal positive video signal of 1 V (p-p) is present at pin VSO.

Buffer amplifier and noise clipper

The input impedance of the 7 dB wideband CVBS buffer amplifier (with internal feedback) is suitable for ceramic sound trap filters. Pin CVBS provides a positive video signal of 2 V (p-p). Noise clipping is provided internally.

Sound demodulation

LIMITER AMPLIFIER

The FM sound intercarrier signal is fed to pin SI and through a limiter amplifier before it is demodulated. The result is high sensitivity and AM suppression. The limiter amplifier consists of 7 stages which are internally AC-coupled in order to minimizing the DC offset.

FM-PLL DETECTOR

The FM-PLL demodulator consists of an RC oscillator, loop filter and phase detector. The oscillator frequency is locked on the FM intercarrier signal from the limiter amplifier. As a result of this locking, the RC oscillator is frequency modulated. The modulating voltage (AF signal) is used to control the oscillator frequency. By this, the FM-PLL operates as an FM demodulator.

AF AMPLIFIER

The audio frequency amplifier with internal feedback is designed for high gain and high common-mode rejection. The low-level AF signal output from the FM-PLL demodulator is amplified and buffered in a low-ohmic audio output stage. An external decoupling capacitor C_{DAF} removes the DC voltage from the audio amplifier input.

By using the sound mute switch (pin MUTE) the AF amplifier is set in the mute state.

Single standard VIF-PLL demodulator and FM-PLL detector

TDA9801

LIMITING VALUES

In accordance with the Absolute Maximum Rating System (IEC 134).

SYMBOL	PARAMETER	CONDITIONS	MIN.	MAX.	UNIT
V_P	supply voltage	$I_P = 70 \text{ mA}$; $T_{\text{amb}} = 70 \text{ }^\circ\text{C}$; maximum chip temperature			
		125 $^\circ\text{C}$ for TDA9801	0	9.9	V
		128 $^\circ\text{C}$ for TDA9801T	0	9.9	V
V_n	voltage on pins VIF1, VIF2, AFC and AGC pin TAGC		0	V_P	V
			–	13.2	V
$t_{\text{sc(max)}}$	maximum short-circuit time	to ground or V_P	–	10	s
T_{stg}	storage temperature		–25	+150	$^\circ\text{C}$
T_{amb}	ambient temperature		–20	+70	$^\circ\text{C}$
V_{es}	electrostatic handling voltage	note 1	–300	+300	V

Notes

- Machine model class B ($L = 2.5 \text{ } \mu\text{H}$).

THERMAL CHARACTERISTICS

SYMBOL	PARAMETER	CONDITIONS	VALUE	UNIT	
$R_{\text{th(j-a)}}$	thermal resistance from junction to ambient	in free air			
			TDA9801	73	K/W
			TDA9801T	85	K/W

CHARACTERISTICS

$V_P = 5 \text{ V}$; $T_{\text{amb}} = 25 \text{ }^\circ\text{C}$; see Table 1 for input frequencies and picture-to-sound carrier ratios; $V_{i(\text{VIF})(\text{rms})} = 10 \text{ mV}$ (sync pulse level); IF input from $50 \text{ } \Omega$ via broadband transformer 1 : 1; DSB video modulation; 10% residual carrier; video signal in accordance with "CCIR, line 17" or "NTC-7 Composite"; measurements taken in test circuit of Fig.12; unless otherwise specified.

SYMBOL	PARAMETER	CONDITIONS	MIN.	TYP.	MAX.	UNIT
Supply: pin V_P						
V_P	supply voltage	note 1	4.5	5.0	9.9	V
I_P	supply current	$V_P = 5 \text{ V}$	51	60	70	mA
		$V_P = 9 \text{ V}$	52	61	70	mA
Vision IF input: pins VIF1 and VIF2						
$V_{i(\text{sens})(\text{VIF})(\text{rms})}$	sensitivity of VIF input voltage (RMS value)	–1 dB video at output				
		$f_{\text{PC}} = 38.9 \text{ or } 45.75 \text{ MHz}$	–	50	90	μV
		$f_{\text{PC}} = 58.75 \text{ MHz}$	–	60	100	μV
$V_{i(\text{max})(\text{rms})}$	maximum VIF input voltage (RMS value)	1 dB video at output				
		$f_{\text{PC}} = 38.9 \text{ or } 45.75 \text{ MHz}$	70	150	–	mV
		$f_{\text{PC}} = 58.75 \text{ MHz}$	80	160	–	mV
V_I	DC input voltage		3.0	3.4	3.8	V

Single standard VIF-PLL demodulator and FM-PLL detector

TDA9801

SYMBOL	PARAMETER	CONDITIONS	MIN.	TYP.	MAX.	UNIT
ΔV_{int}	internal IF amplitude difference between picture and sound carrier	within AGC range	–	0.7	1	dB
G_{IF}	IF gain control	see Fig.6 $f_{\text{PC}} = 38.9$ or 45.75 MHz $f_{\text{PC}} = 58.75$ MHz	64 62	70 68	– –	dB dB
$B_{\text{IF}(-3\text{dB})}$	–3 dB IF bandwidth	upper limit cut-off frequency	70	100	–	MHz
$R_{\text{i(dif)}}$	differential input resistance	note 2	1.7	2.2	2.7	k Ω
$C_{\text{i(dif)}}$	differential input capacitance	note 2	1.2	1.7	2.5	pF
VCO and video demodulator; note 3						
$f_{\text{VCO(max)}}$	maximum VCO frequency	for carrier regeneration; $f = 2f_{\text{PC}}$	125	130	–	MHz
$\Delta f_{\text{VCO}/\Delta T}$	VCO frequency variation with temperature	free running; $I_{\text{AFC}} = 0$; note 4	–	–	$\pm 20 \times 10^{-6}$	K $^{-1}$
$V_{\text{VCO(rms)}}$	VCO voltage swing (RMS value)	measured between pins VCO1 and VCO2 $f_{\text{PC}} = 38.9$ MHz $f_{\text{PC}} = 45.75$ MHz $f_{\text{PC}} = 58.75$ MHz	– – –	120 100 80	– – –	mV mV mV
$f_{\text{cr(PC)}}$	picture carrier capture frequency range	negative	1.4	1.8	–	MHz
		positive	1.4	1.8	–	MHz
t_{acq}	acquisition time	BL = 60 kHz; note 5	–	–	30	ms
$V_{\text{i(sens)(VIF)(rms)}}$	sensitivity of VIF input (RMS value)	PLL still locked; maximum IF gain; note 6	–	50	90	μV
		C/N = 10 dB; note 7	–	100	140	μV
$I_{\text{offset(TPLL)}}$	offset current at pin TPLL	note 8	–	–	± 2.0	μA
Video amplifier output (sound carrier off): pin VSO						
$V_{\text{o(VSO)(p-p)}}$	VSO output voltage (peak-to-peak value)	see Fig.5 $V_{\text{P}} = 5$ V	0.90	1.0	1.25	V
		$V_{\text{P}} = 9$ V	0.95	1.1	1.25	V
V_{sync}	sync pulse voltage level		1.35	1.5	1.6	V
$V_{\text{v(clu)}}$	upper video clipping voltage level		$V_{\text{P}} - 1.1$	$V_{\text{P}} - 1$	–	V
$V_{\text{v(cll)}}$	lower video clipping voltage level		–	0.7	0.9	V
$V_{\text{o(intc)(rms)}}$	intercarrier output voltage (RMS value)	sound carrier on; note 9	–	32	–	mV
R_{o}	output resistance	note 2	–	–	10	Ω
I_{bias}	DC bias current	for internal emitter-follower at pin VSO	1.8	2.5	–	mA

Single standard VIF-PLL demodulator and FM-PLL detector

TDA9801

SYMBOL	PARAMETER	CONDITIONS	MIN.	TYP.	MAX.	UNIT
$I_{o(sink)(max)}$	maximum AC and DC output sink current		1.4	–	–	mA
$I_{o(source)(max)}$	maximum AC and DC output source current		2.0	–	–	mA
$B_{V(-3dB)}$	–3 dB video bandwidth	$C_L < 50 \text{ pF}$; $R_L > 1 \text{ k}\Omega$	7	10	–	MHz
$\alpha_{H(sup)}$	harmonics suppression in video signal	$C_L < 50 \text{ pF}$; $R_L > 1 \text{ k}\Omega$; note 10	35	40	–	dB
$PSRR_{VSO}$	power supply ripple rejection at pin VSO	see Fig.7	32	35	–	dB
Buffer amplifier and noise clipper input: pin VI						
R_i	input resistance		2.6	3.3	4.0	k Ω
C_i	input capacitance		1.4	2	3.0	pF
V_I	DC input voltage	pin VI not connected	1.5	1.8	2.1	V
Buffer amplifier output: pin CVBS						
G_V	voltage gain	note 11	6	7	7.5	dB
$B_{V(-3dB)}$	–3 dB video bandwidth	$C_L < 20 \text{ pF}$; $R_L > 1 \text{ k}\Omega$	8	11	–	MHz
$V_{o(v)(p-p)}$	video output voltage (peak-to-peak value)	sound carrier off; see Fig.12	1.7	2.0	2.3	V
$V_{V(clu)}$	upper video clipping voltage level		3.9	4.0	–	V
$V_{V(cll)}$	lower video clipping voltage level		–	1.0	1.1	V
V_{sync}	sync pulse voltage level		–	1.35	–	V
R_o	output resistance		–	–	10	Ω
I_{bias}	DC bias current	internal emitter-follower at pin CVBS	1.8	2.5	–	mA
$I_{o(sink)(max)}$	maximum AC and DC output sink current		1.4	–	–	mA
$I_{o(source)(max)}$	maximum AC and DC output source current		2.4	–	–	mA
Measurements from VIF inputs to CVBS output (330 Ω connected between pins VSO and VI, sound carrier off)						
$V_{o(CVBS)(p-p)}$	CVBS output voltage (peak-to-peak value)	$V_P = 5 \text{ V}$	1.7	2.0	2.3	V
		$V_P = 9 \text{ V}$	1.8	2.2	2.6	V
$\Delta V_{o(CVBS)}$	deviation of CVBS output voltage	at B/G standard	–	–	–	–
		50 dB gain control	–	–	0.5	dB
		30 dB gain control	–	–	0.1	dB
$\Delta V_{o(bl)}$	black level tilt	gain variation; note 12	–	–	1	%
G_{dif}	differential gain	"CCIR, line 330" or "NTC-7 Composite"	–	2	5	%
Φ_{dif}	differential phase	"CCIR, line 330" or "NTC-7 Composite"	–	2	4	deg
$B_{V(-3dB)}$	–3 dB video bandwidth	$C_L < 20 \text{ pF}$; $R_L > 1 \text{ k}\Omega$	6	8	–	MHz

Single standard VIF-PLL demodulator and FM-PLL detector

TDA9801

SYMBOL	PARAMETER	CONDITIONS	MIN.	TYP.	MAX.	UNIT
S/N _W	weighted signal-to-noise ratio	see Fig.3; note 13 V _P = 5 V	56	60	–	dB
		V _P = 9 V	55	59	–	dB
α _{IM(0.92/1.1)}	intermodulation attenuation at f = 0.92 or 1.1 MHz	see Fig.4; note 14 for BLUE	56	62	–	dB
		for YELLOW	58	64	–	dB
α _{IM(2.76/3.3)}	intermodulation attenuation at f = 2.76 or 3.3 MHz	see Fig.4; note 14 for BLUE	56	62	–	dB
		for YELLOW	57	63	–	dB
ΔV _{r(PC)(rms)}	residual picture carrier (RMS value)	fundamental wave	–	1	10	mV
		harmonics	–	1	10	mV
α _{H(sup)}	harmonics suppression in video signal	note 10	35	40	–	dB
PSRR _{CVBS}	power supply ripple rejection at pin CVBS	see Fig.7	25	28	–	dB
AGC detector output: pin AGC						
t _{res}	response time	at 50 dB amplitude step of input signal				
		for increasing step	–	1	10	ms
		for decreasing step	–	50	100	ms
I _{ch}	charging current	note 12	0.82	1.1	1.38	mA
I _{dch}	discharging current		16	22	28	μA
V _o	gain control output voltage	see Fig.6 maximum gain	0	–	–	V
		minimum gain	–	–	V _P – 0.7	V
Tuner AGC						
V _{i(VIF)(rms)}	VIF input voltage (RMS value)	for onset tuner takeover point				
		minimum level with R _{TOP} = 22 kΩ	–	–	5	mV
		maximum level with R _{TOP} = 0 Ω	50	–	–	mV
QV _{i(VIF)(rms)}	accuracy level of tuner takeover point (RMS value)	R _{TOP} = 13 kΩ; I _{TAGC} = 0.4 mA	7	–	14	mV
ΔV _{i(VIF)/ΔT}	variation of tuner takeover point with temperature	I _{TAGC} = 0.4 mA	–	0.02	0.06	dB/K
ΔG _{IF}	IF slip by automatic gain control	tuner gain current from 20 to 80%	–	6	8	dB

Single standard VIF-PLL demodulator and FM-PLL detector

TDA9801

SYMBOL	PARAMETER	CONDITIONS	MIN.	TYP.	MAX.	UNIT
TUNER AGC OUTPUT: pin TAGC						
V_{\max}	maximum voltage	from external source; note 2	–	–	13.2	V
V_{sat}	saturation voltage	$I_{\text{TAGC}} = 1.7 \text{ mA}$	–	–	0.2	V
I_{sink}	sink current	see Fig.6 no tuner gain reduction maximum tuner gain reduction	– 1.7	0.1 2.0	0.3 2.6	μA mA
AFC detector: pin AFC; note 15						
CR_{stps}	control steepness	equal to $\Delta I_{\text{AFC}}/\Delta f_{\text{VIF}}$ see Table 2 $f_{\text{PC}} = 38.9 \text{ MHz}$ $f_{\text{PC}} = 45.75 \text{ MHz}$ $f_{\text{PC}} = 58.75 \text{ MHz}$	–0.5 –0.4 –0.3	–0.75 –0.65 –0.55	–1.0 –0.9 –0.8	$\mu\text{A/kHz}$ $\mu\text{A/kHz}$ $\mu\text{A/kHz}$
$\Delta f/\Delta T$	frequency variation with temperature	$I_{\text{AFC}} = 0$; note 4	–	–	$\pm 20 \times 10^6$	K^{-1}
V_o	output voltage	without external components; see Fig.8 upper limit lower limit	$V_P - 0.5$ –	$V_P - 0.3$ 0.3	– 0.5	V V
I_o	output current	see Fig.8 source current sink current	150 150	200 200	250 250	μA μA
$\Delta I_{r(v)(p-p)}$	residual video modulation current (peak-to-peak value)		–	20	30	μA
Sound mute switch: pin MUTE; note 16						
V_{IL}	LOW-level input voltage	mute on	0	–	0.8	V
V_{IH}	HIGH-level input voltage	mute off	1.5	–	V_P	V
I_{IL}	LOW-level input current	$V_{\text{MUTE}} = 0 \text{ V}$	–	–300	–360	μA
α_{mute}	mute attenuation	$V_{\text{MUTE}} = 0 \text{ V}$	70	80	–	dB
$\Delta V_{\text{offset(MUTE)}}$	DC offset voltage at pin MUTE	at switching to mute on state (plop)	–	100	500	mV
FM sound limiter amplifier input: pin SI; note 17						
$V_{i(\text{FM})(\text{rms})}$	FM input voltage (RMS value)	"CCIR468-4" $S/N = 40 \text{ dB}$; see Fig.10 $\alpha_{\text{AM}} = 40 \text{ dB}$; $f = 1 \text{ kHz}$; $m = 0.3$	– –	200 1	300 –	μV mV
$V_{i(\text{FM})(\text{max})(\text{rms})}$	maximum FM input handling voltage (RMS value)		200	–	–	mV
V_I	DC input voltage		2.3	2.6	2.9	V

Single standard VIF-PLL demodulator and FM-PLL detector

TDA9801

SYMBOL	PARAMETER	CONDITIONS	MIN.	TYP.	MAX.	UNIT
R_i	input resistance	note 2	480	600	720	Ω
α_{AM}	AM suppression	AM signal: $f = 1$ kHz; $m = 0.3$; see Fig.9	46	50	–	dB
$f_{res(-3dB)}$	frequency response	–3 dB points of lower and upper limits of IF sound cut-off frequency	3.5	–	10	MHz
FM-PLL sound detector and AF amplifier; note 17						
$f_{cr(PLL)}$	catching range of PLL	upper limit	7	–	–	MHz
		lower limit	–	–	4	MHz
$f_{hr(PLL)}$	holding range of PLL	upper limit	8	–	–	MHz
		lower limit	–	–	3.5	MHz
t_{acq}	acquisition time		–	–	4	μs
Δf_{AF}	audio frequency deviation	THD < 1.5%; note 18	–	–	± 50	kHz
$B_{AF(-3dB)}$	–3 dB audio frequency bandwidth		95	120	–	kHz
THD	total harmonic distortion	27 kHz FM deviation; $R_3 = 0 \Omega$; note 18	–	0.25	0.5	%
S/N_W	weighted signal-to-noise ratio	"CCIR 468-4"; see Fig.10	50	55	–	dB
$\Delta V_{r(SC)(rms)}$	residual sound carrier (RMS value)	fundamental wave and harmonics	–	–	75	mV
AUDIO OUTPUT: PIN AF						
$V_{o(AF)(rms)}$	AF output voltage (RMS value)	$\Delta f_{AF} = \pm 27$ kHz; B/G standard; see Fig.10	400	500	600	mV
		$\Delta f_{AF} = \pm 25$ kHz; M standard; see Fig.10	370	460	550	mV
$V_{o(AF)(max)(rms)}$	maximum AF output handling voltage (RMS value)	THD < 1.5%	0.8	–	–	V
$\Delta V_{o(AF)}/\Delta T$	AF output voltage variation with temperature		–	3×10^{-3}	7×10^{-3}	dB/K
R_o	output resistance	note 2	–	200	–	Ω
R_L	load resistance	AC-coupled at pin AF	2.2	–	–	k Ω
$I_{o(sink/source)(max)}$	maximum sink or source output current	AC and DC	–	–	1.5	mA
V_o	DC output voltage		2.1	2.5	2.9	V
$PSRR_{AF}$	power supply ripple rejection at pin AF	$R_3 = 0 \Omega$; see Fig.7; note 18	24	30	–	dB
DECOUPLING CAPACITOR: PIN DAF						
V_{DAF}	DC voltage at decoupling capacitor	voltage depends on VCO frequency; note 19	1.5	–	3.3	V

Single standard VIF-PLL demodulator and FM-PLL detector

TDA9801

SYMBOL	PARAMETER	CONDITIONS	MIN.	TYP.	MAX.	UNIT
Measurements from VIF input to AF output; notes 20 and 21; see Fig.13						
S/N _W	weighted signal-to-noise ratio	"CCIR 468-4"				
		black picture (sync only)	46	52	–	dB
		white picture	42	48	–	dB
		colour bar	40	46	–	dB

Notes

- Values of video and sound parameters can be decreased at $V_P = 4.5$ V.
- This parameter is not tested during production and is only given as application information for designing the television receiver.
- Conditions for video demodulator:
 - Loop bandwidth: $BL = 60$ kHz, natural frequency $f_n = 15$ kHz, damping factor $d = 2$, calculated with grey level and FPLL input level
 - Resonance circuit of VCO: $Q_o > 50$, see Table 2 for the value of the external capacitor C; $C_{VCO} = 8.5$ pF, loop voltage is approximately 2.6 V at $V_P = 5$ V and approximately 2.7 V at $V_P = 9$ V.
- Temperature coefficient of the external LC circuit is equal to zero.
- $V_{i(VIF)(rms)} = 10$ mV; $\Delta f = 1$ MHz (VCO frequency offset related to f_{PC}); white picture video modulation.
- $V_{i(VIF)}$ signal for nominal video signal.
- Broadband transformer at the VIF input (see Fig.12). The C/N ratio at the VIF input for 'lock-in' is defined as the VIF input signal (RMS value of sync pulse level) related to a superimposed 5 MHz band-limited white noise signal (RMS value). The video modulation is for white picture.
- The offset current is measured between pin TPLL and half of the supply voltage ($V_P = 2.5$ V) under the conditions:
 - no input signal at VIF inputs
 - IF amplifier gain at minimum ($V_{AGC} = V_P$) and pin ADJ is left open-circuit.
- The intercarrier output signal is superimposed to the video signal at pin VSO and can be calculated by the following formula:

$$V_{o(intc)(rms)} = 1.0 \text{ V (p-p)} \times \frac{1}{2\sqrt{2}} \times 10^{\frac{\frac{V_{i(SC)}}{V_{i(PC)}} \text{ (dB)} + 6 \text{ dB} \pm 2 \text{ dB}}{20}}$$

where

- 1.0 V (p-p) = video output signal as reference
- $\frac{1}{2\sqrt{2}}$ = correction term for RMS value
- $\frac{V_{i(SC)}}{V_{i(PC)}} \text{ (dB)}$ = sound-to-picture carrier ratio at VIF inputs in dB
- 6 dB = correction term of internal circuitry
- ± 2 dB = tolerance of video output and intercarrier output amplitude $V_{o(intc)(rms)}$.
- Example for SAW filter G1962:
sound shelf value = 20 dB,

$$\frac{V_{i(SC)}}{V_{i(PC)}} = -27 \text{ dB} \Rightarrow V_{o(intc)(rms)} = 32 \text{ mV (typical value)}$$

Single standard VIF-PLL demodulator and FM-PLL detector

TDA9801

10. Measurements taken with SAW filter G1962; VSB modulation; $f_{\text{video}} > 0.5$ MHz; loop bandwidth BL = 60 kHz.
11. The 7 dB buffer amplifier gain accounts for 1 dB loss in the sound trap. The buffer output signal is typical 2 V (p-p). If no sound trap is applied a resistor of 330 Ω must be connected between pins VSO and VI.
12. The leakage current of C_{AGC} should not exceed 1 μA . Larger currents will increase the tilt.
13. S/N is the ratio of the black-to-white amplitude to the black level noise voltage (RMS value) at pin CVBS. B = 5 MHz weighted in accordance with "CCIR 567" at a source impedance of 50 Ω .
14. The intermodulation figures are defined:
- $\alpha_{\text{IM}(0.92/1.1)} = 20 \log \left(\frac{V_o \text{ at } 4.4 \text{ (3.58) MHz}}{V_o \text{ at } 0.92 \text{ (1.1) MHz}} \right) + 3.6 \text{ dB}$
 $\alpha_{\text{IM}(0.92/1.1)}$ value at 0.92 (or 1.1) MHz referenced to black or white signal
 - $\alpha_{\text{IM}(2.76/3.3)} = 20 \log \left(\frac{V_o \text{ at } 4.4 \text{ (3.58) MHz}}{V_o \text{ at } 2.76 \text{ (3.3) MHz}} \right)$
 $\alpha_{\text{IM}(2.76/3.3)}$ value at 2.76 (or 3.3) MHz referenced to colour carrier.
15. To match the AFC output signal to different tuning systems a current source output is provided (see Fig.8).
16. The no mute state is also valid when pin MUTE is not connected.
17. The input signal is provided by an external generator with 50 Ω source impedance, AC-coupled with a 10 nF capacitor, $f_{\text{mod}} = 1$ kHz and 27 kHz (54% FM deviation) of audio reference. A VIF input signal is not permitted. Pin AGC has to be connected to the supply voltage. Measurements are taken at 50 μs de-emphasis (75 μs at the M standard).
18. To allow a higher frequency deviation, the value of resistor R3 on pin DAF (see Fig.13) has to be increased. However, the AF output signal must not exceed 0.5 V (nominal value) for THD = 0.2%. R3 = 4.7 k Ω provides -6 dB amplification.
19. The leakage current of the 2.2 μF decoupling capacitor should not exceed 100 nA.
20. For all S/N measurements the used vision IF modulator has to meet the following specifications:
- Incidental phase modulation for black-to-white jump less than 0.5 degrees
 - AF performance, measured with the television demodulator AMF2 (audio output, weighted S/N ratio), better than 60 dB (deviation 27 kHz) for white picture video modulation.
21. Input signal according to B/G standard of Table 1:
- Input: $V_{i(\text{VIF})(\text{rms})} = 10$ mV, VSB modulation and 10% residual carrier
 - Reference: FM deviation = 27 kHz and measurements are taken at 50 μs de-emphasis.

Table 1 Input frequencies and carrier ratios

SYMBOL	DESCRIPTION	STANDARD			UNIT
		B/G	M/N	M	
f_{PC}	picture carrier frequency	38.9	45.75	58.75	MHz
f_{SC}	sound carrier frequency	33.4	41.25	54.25	MHz
PC/SC	picture-to-sound carrier ratio	13	7	7	dB

Single standard VIF-PLL demodulator
and FM-PLL detector

TDA9801

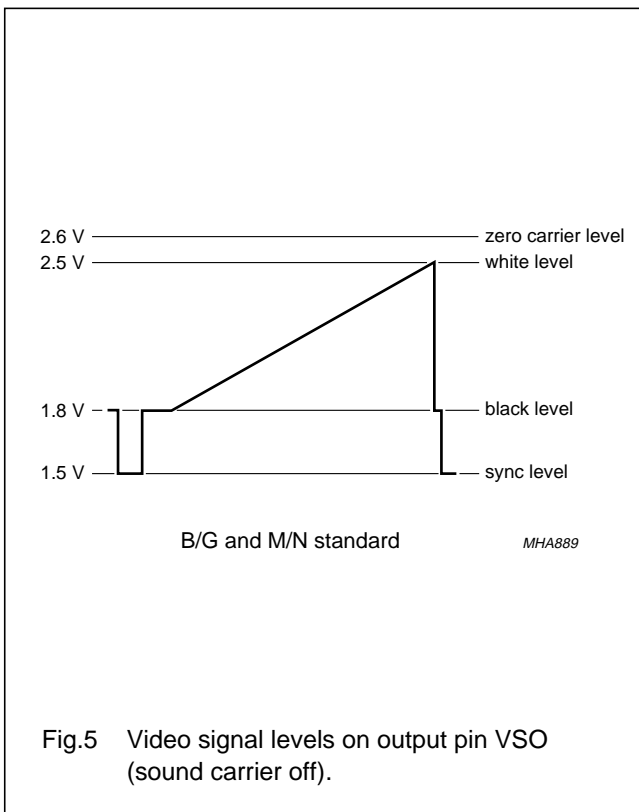
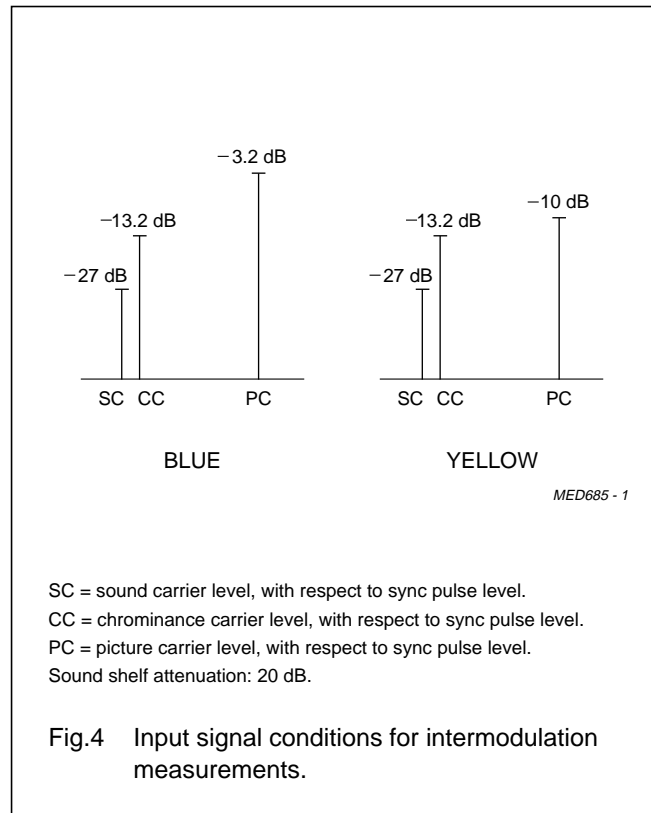
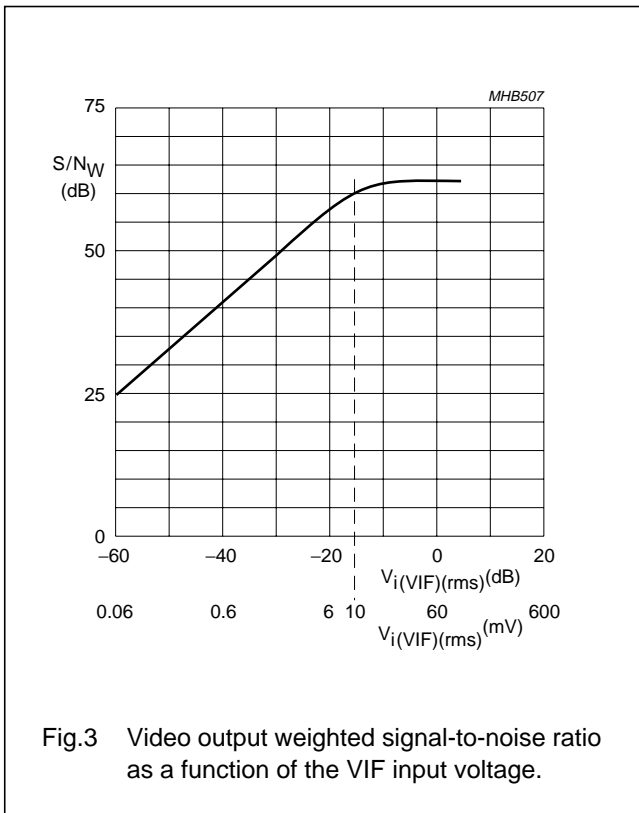

Single standard VIF-PLL demodulator
and FM-PLL detector

TDA9801

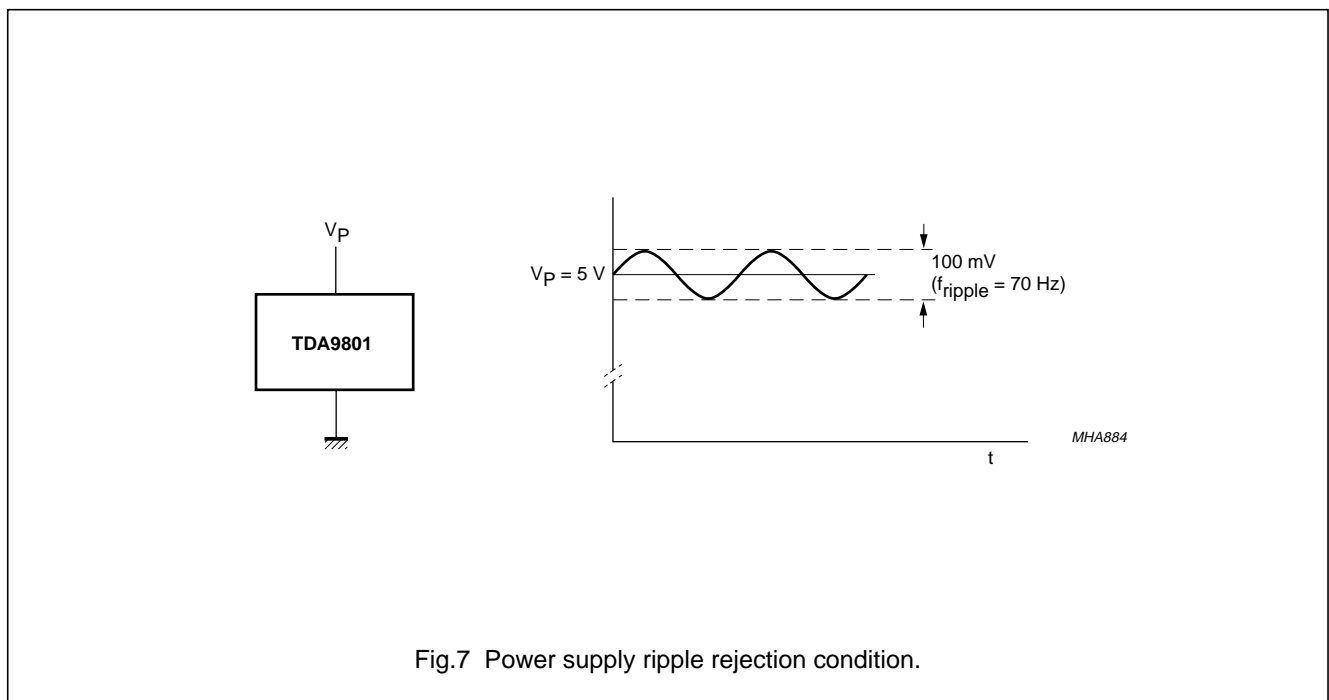
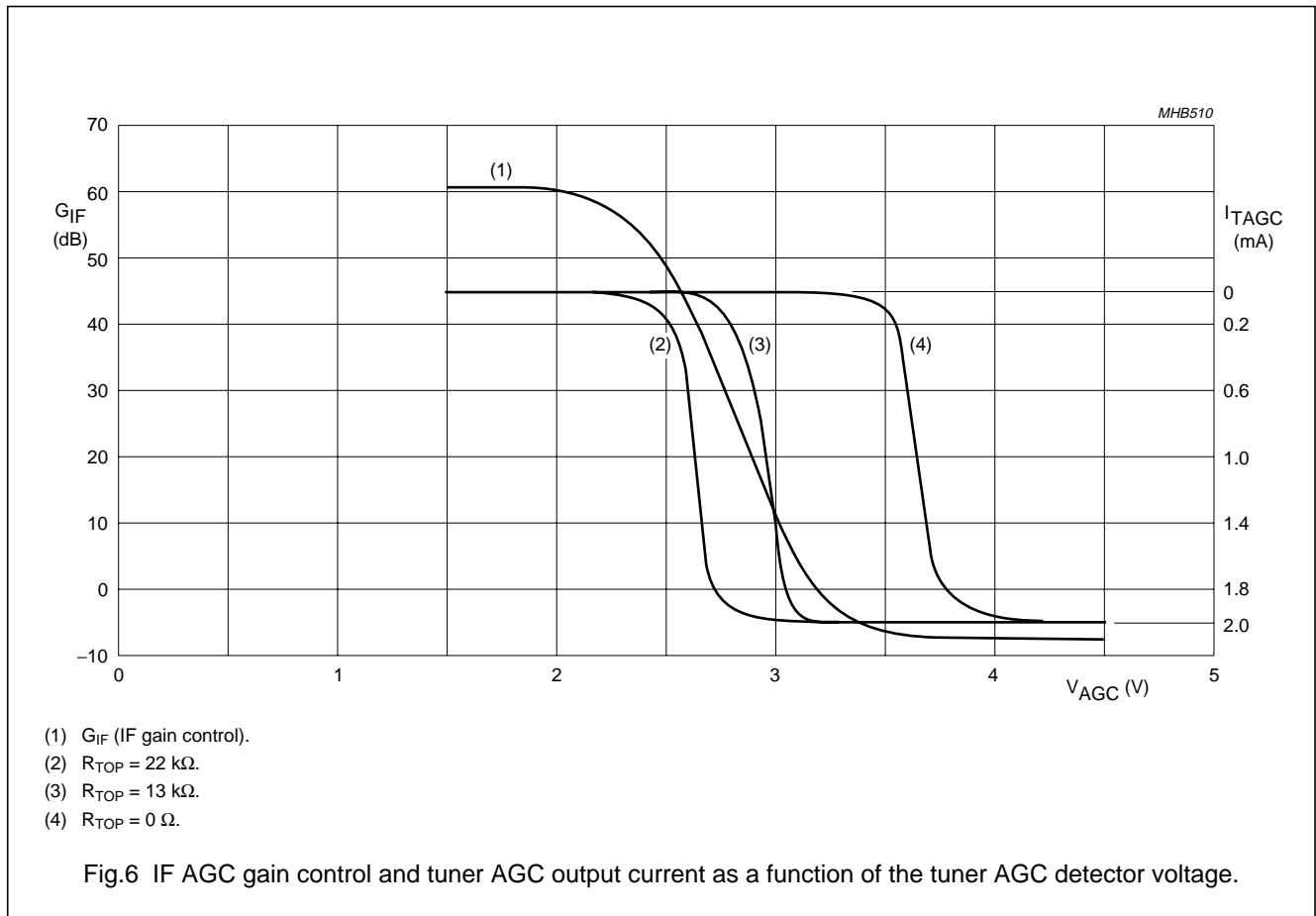

Single standard VIF-PLL demodulator
and FM-PLL detector

TDA9801

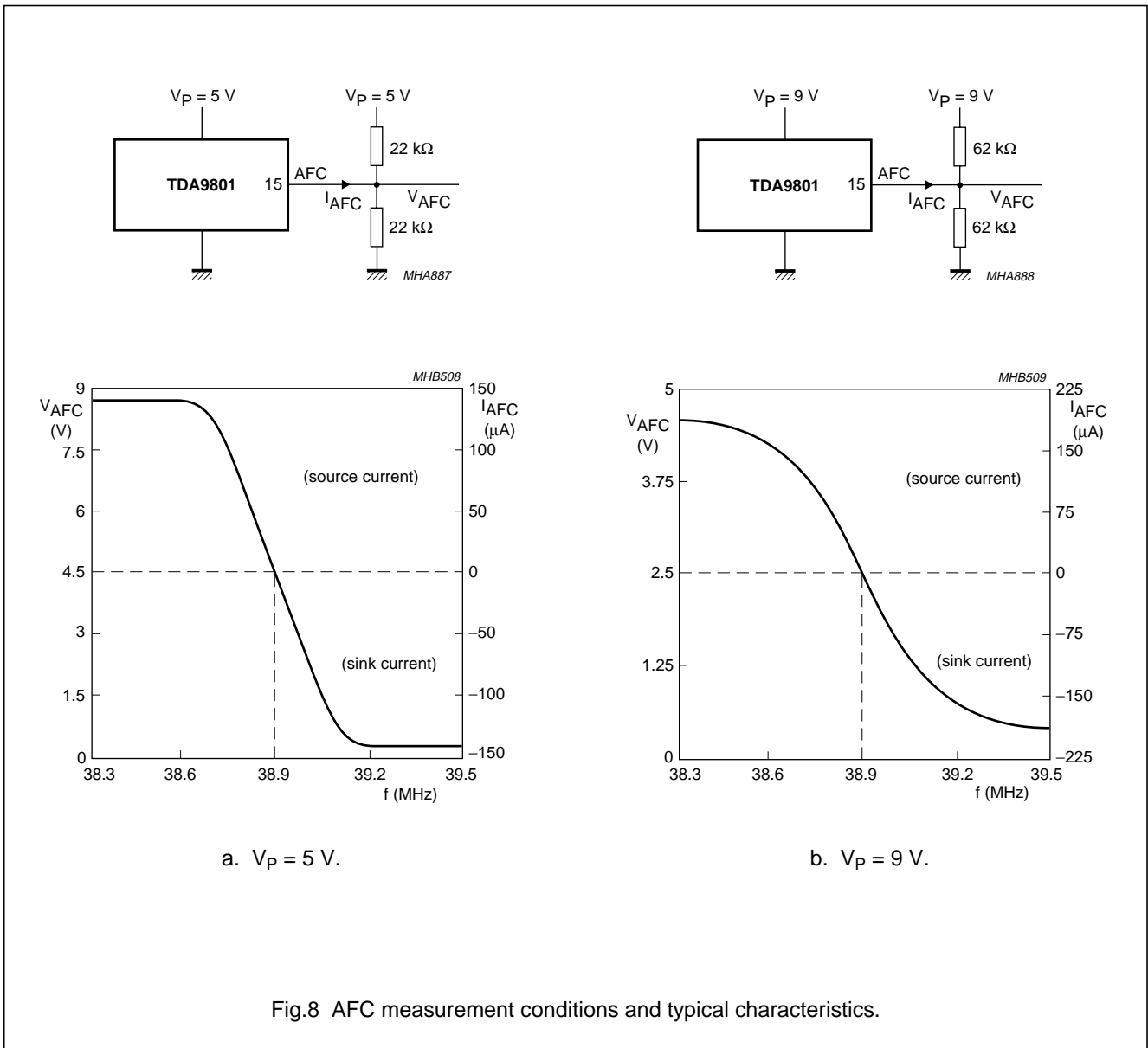

Single standard VIF-PLL demodulator
and FM-PLL detector

TDA9801

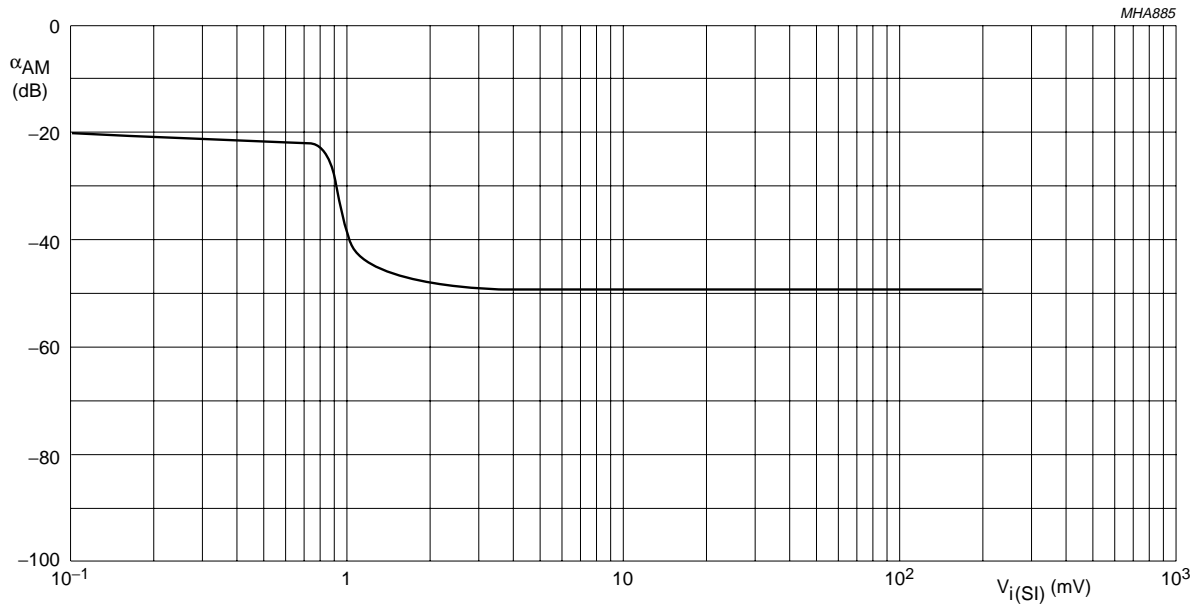
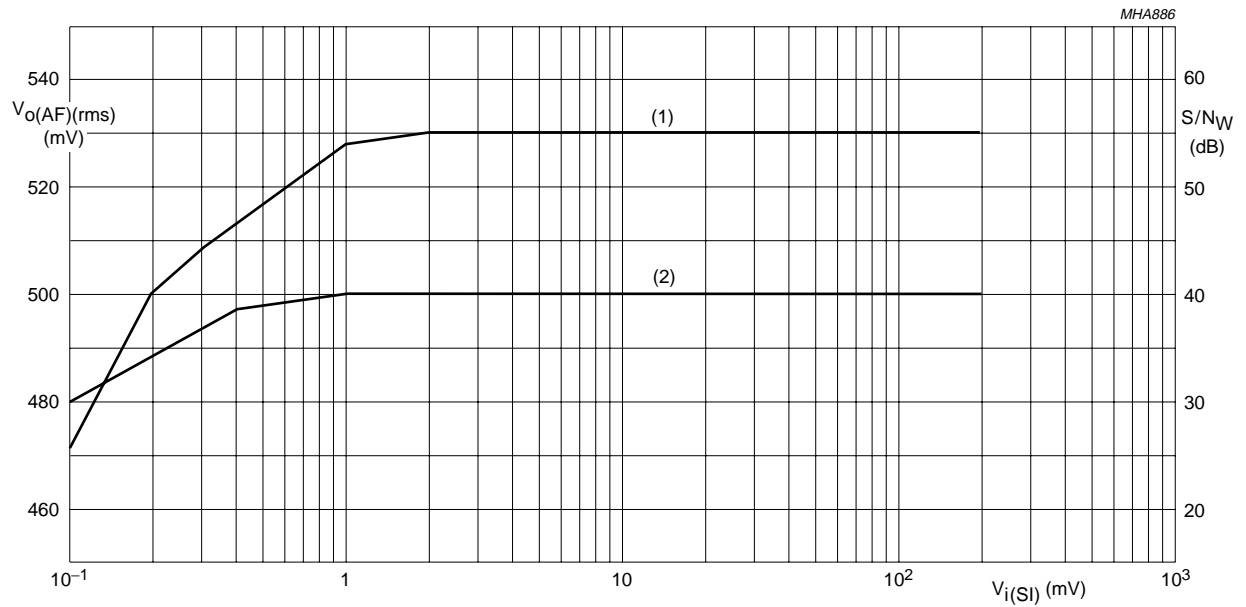

Fig.9 AM suppression (typical value) of the FM limiter amplifier as a function of the input voltage.



- (1) Signal-to-noise ratio (weighted).
- (2) AF output signal (typical value).

Fig.10 AF output signal and signal-to-noise ratio as a function of the input voltage.

Single standard VIF-PLL demodulator
and FM-PLL detector

TDA9801

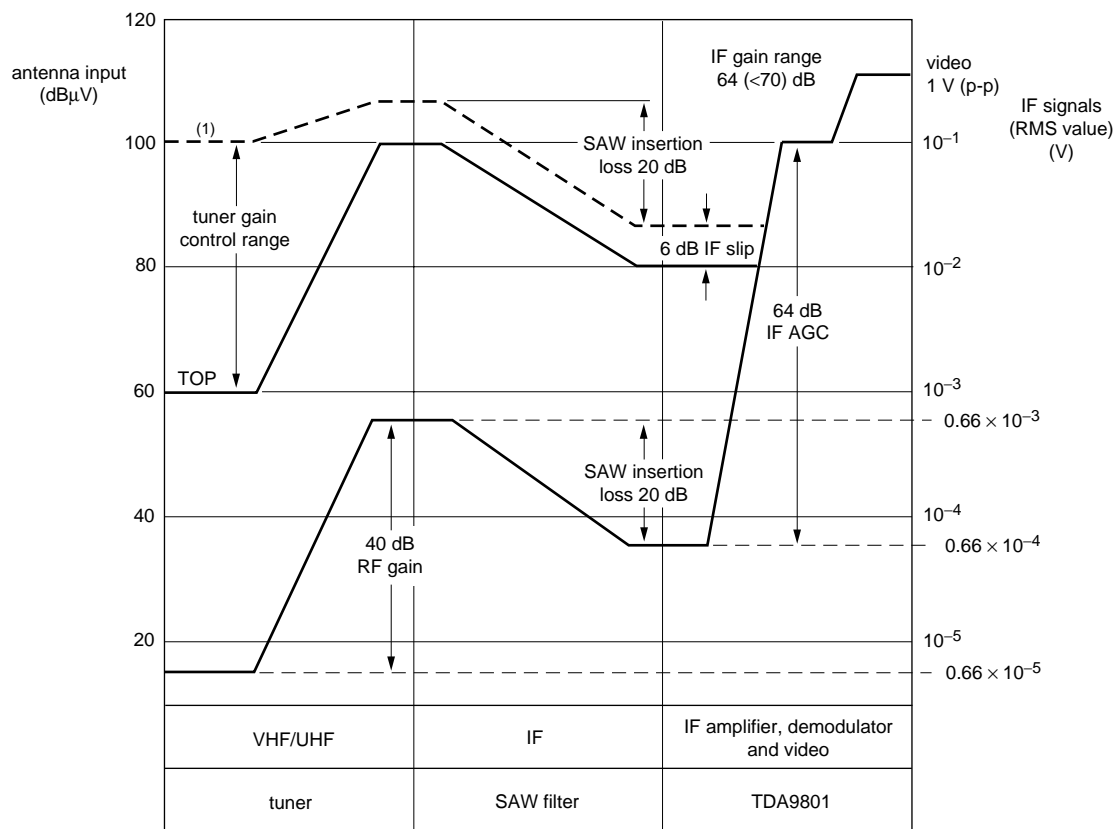

MHA883

(1) Depends on TOP.

Fig.11 Front-end level diagram.

Single standard VIF-PLL demodulator
and FM-PLL detector

TDA9801

INTERNAL CIRCUITRY

PIN	SYMBOL	DC VOLTAGE (V)	EQUIVALENT CIRCUIT (WITHOUT ESD PROTECTION CIRCUIT)
1	VIF1	3.4	
2	VIF2	3.4	
3	TOP	0 to 1.9	
4	ADJ	0 to 0.4	

Single standard VIF-PLL demodulator
and FM-PLL detector

TDA9801

PIN	SYMBOL	DC VOLTAGE (V)	EQUIVALENT CIRCUIT (WITHOUT ESD PROTECTION CIRCUIT)
5	MUTE	0 to V_P	
6	TPLL	1.5 to 4.0	
7	CVBS	sync pulse level: 1.35	
8	n.c.	—	

Single standard VIF-PLL demodulator
and FM-PLL detector

TDA9801

PIN	SYMBOL	DC VOLTAGE (V)	EQUIVALENT CIRCUIT (WITHOUT ESD PROTECTION CIRCUIT)
9	AF	2.5	<p>MHB517</p>
10	DAF	1.5 to 3.3	<p>MHB518</p>
11	SI	2.6	<p>MHB519</p>
12	TAGC	0 to 13.2	<p>MHB520</p>
13	VSO	sync pulse level: 1.5	<p>MHB521</p>

Single standard VIF-PLL demodulator
and FM-PLL detector

TDA9801

PIN	SYMBOL	DC VOLTAGE (V)	EQUIVALENT CIRCUIT (WITHOUT ESD PROTECTION CIRCUIT)
14	VI	1.8	<p>The circuit for pin 14 (VI) shows a 3.6V supply connected to a 6.6 kΩ resistor. This resistor is connected to pin 14. Pin 14 is also connected to a 5 kΩ resistor to ground and a 2 kΩ resistor to the base of an MHB522 component.</p>
15	AFC	0.3 to $V_P - 0.3$	<p>The circuit for pin 15 (AFC) shows a 200 µA current source connected to pin 15. Pin 15 is also connected to two 1 kΩ resistors to ground. The circuit includes an MHB523 component.</p>
16	VCO1	2.7	<p>The circuit for pins 16 (VCO1) and 17 (VCO2) shows a 500 µA current source connected to pin 16. Pin 16 is also connected to a 420 Ω resistor to ground. Pin 17 is connected to a 420 Ω resistor to ground and a 50 Ω resistor to a 2.8V supply. The circuit includes an MHB524 component.</p>
17	VCO2	2.7	

Single standard VIF-PLL demodulator
and FM-PLL detector

TDA9801

PIN	SYMBOL	DC VOLTAGE (V)	EQUIVALENT CIRCUIT (WITHOUT ESD PROTECTION CIRCUIT)
18	GND	0	
19	AGC	1.5 to 4.0	
20	V _P	V _P	

Single standard VIF-PLL demodulator and FM-PLL detector

TDA9801

TEST AND APPLICATION INFORMATION

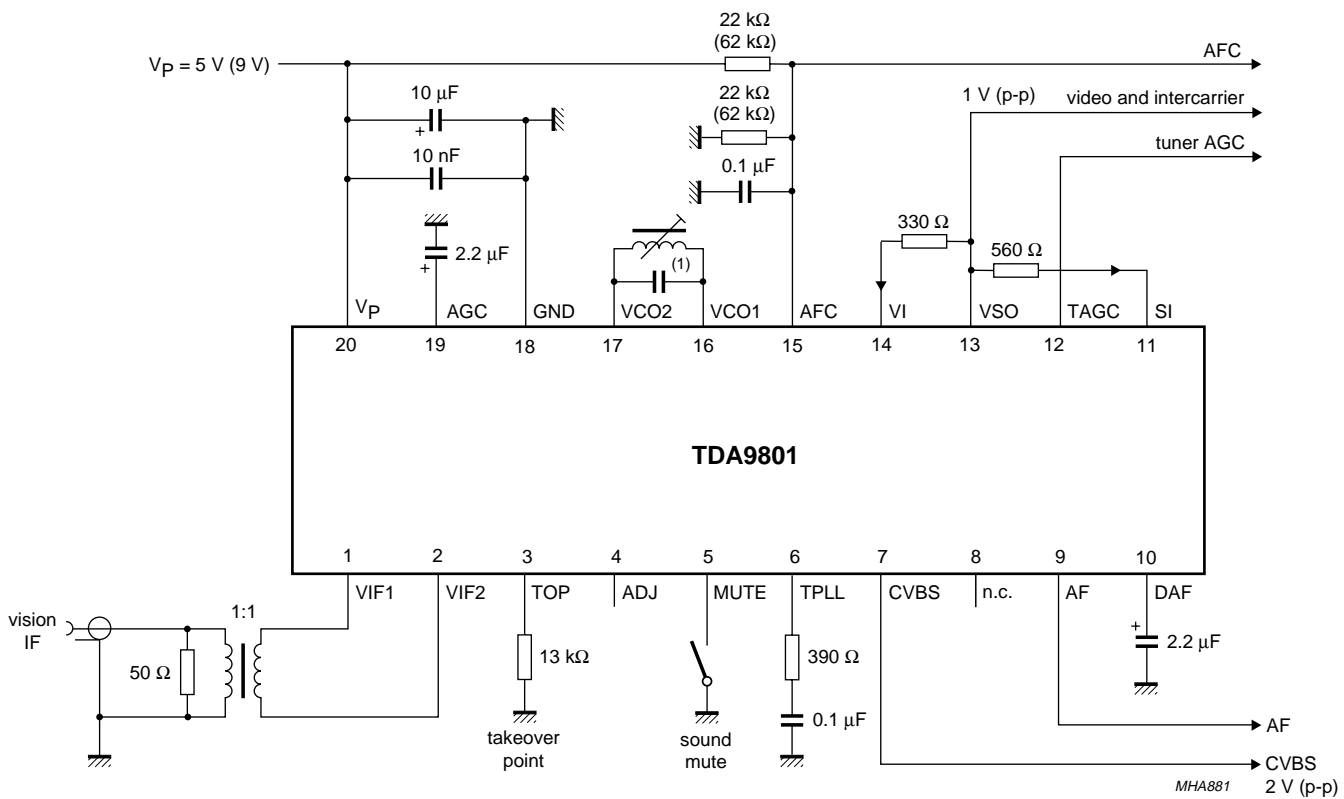

(1) See Table 2.

Fig.12 Test circuit.

Single standard VIF-PLL demodulator and FM-PLL detector

TDA9801

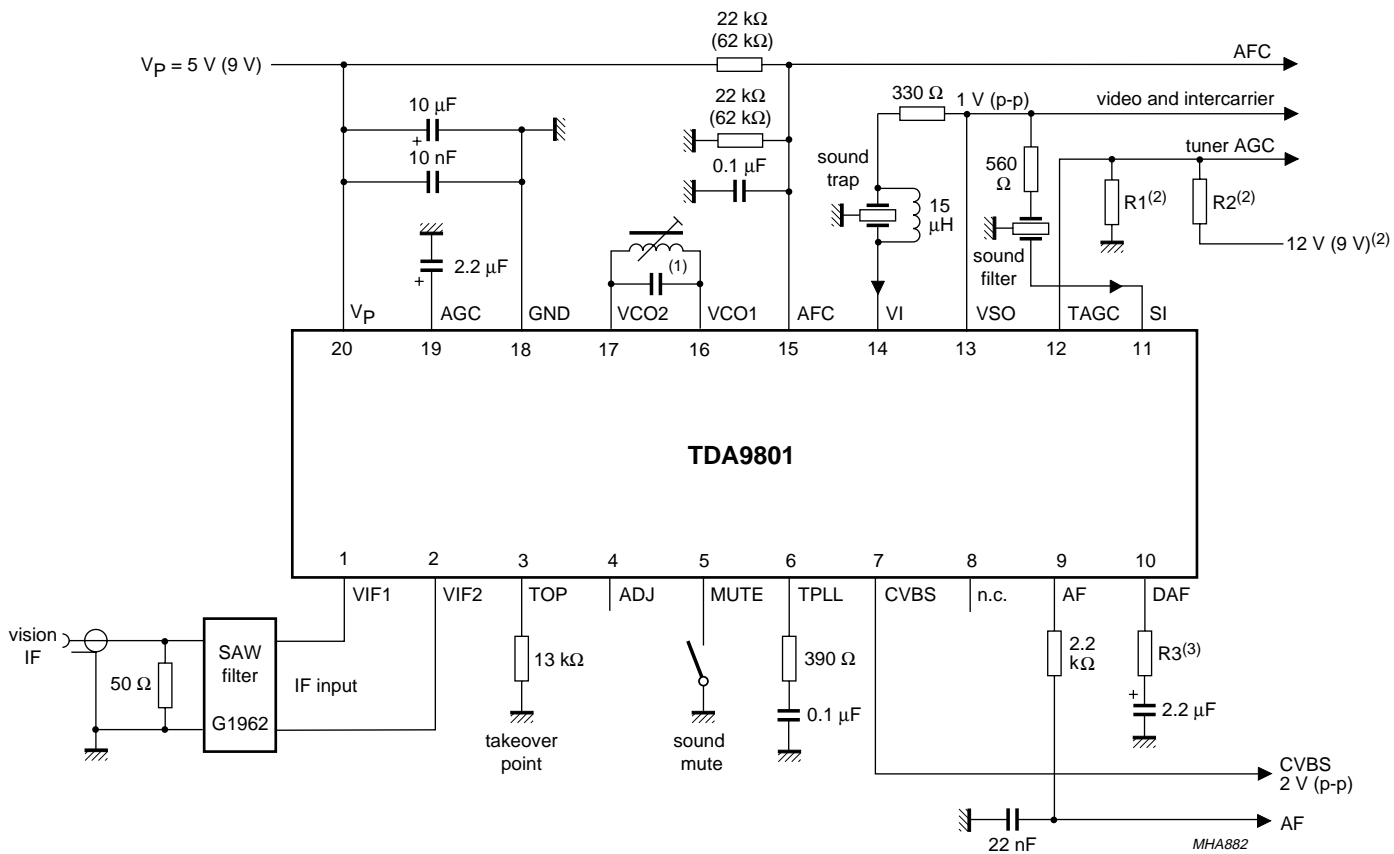

(1) See Table 2.
 (2) Depends on tuner.
 (3) See note 18 of Chapter "Characteristics".

Fig.13 Application circuit.

Single standard VIF-PLL demodulator
and FM-PLL detector

TDA9801

Table 2 Oscillator circuit for different TV standards

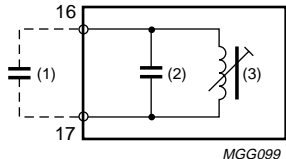
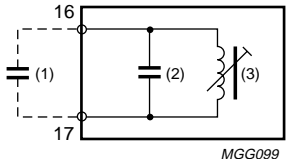
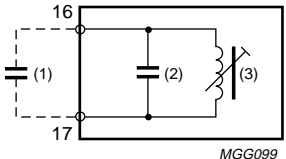
PARAMETER	EUROPE	USA	JAPAN
IF frequency	38.9 MHz	45.75 MHz	58.75 MHz
VCO frequency	77.8 MHz	91.5 MHz	117.5 MHz
Oscillator circuit	 <p>(1) $C_{VCO} = 8.5 \text{ pF}$. (2) $C = 8.2 \pm 0.25 \text{ pF}$. (3) $L = 251 \text{ nH}$.</p>	 <p>(1) $C_{VCO} = 8.5 \text{ pF}$. (2) $C = 10 \pm 0.25 \text{ pF}$. (3) $L = 163 \text{ nH}$.</p>	 <p>(1) $C_{VCO} = 8.5 \text{ pF}$. (2) $C = 15 \pm 0.25 \text{ pF}$. (3) $L = 78 \text{ nH}$.</p>
Toko coil	5KM 369SNS-2010Z	5KMC V369SCS-2370Z	MC139 NE545SNAS100108
Philips ceramic capacitor	2222 632 51828	inside coil	15 pF (SMD; size: 0805)

Single standard VIF-PLL demodulator
and FM-PLL detector

TDA9801

PACKAGE OUTLINES

DIP20: plastic dual in-line package; 20 leads (300 mil)

SOT146-1

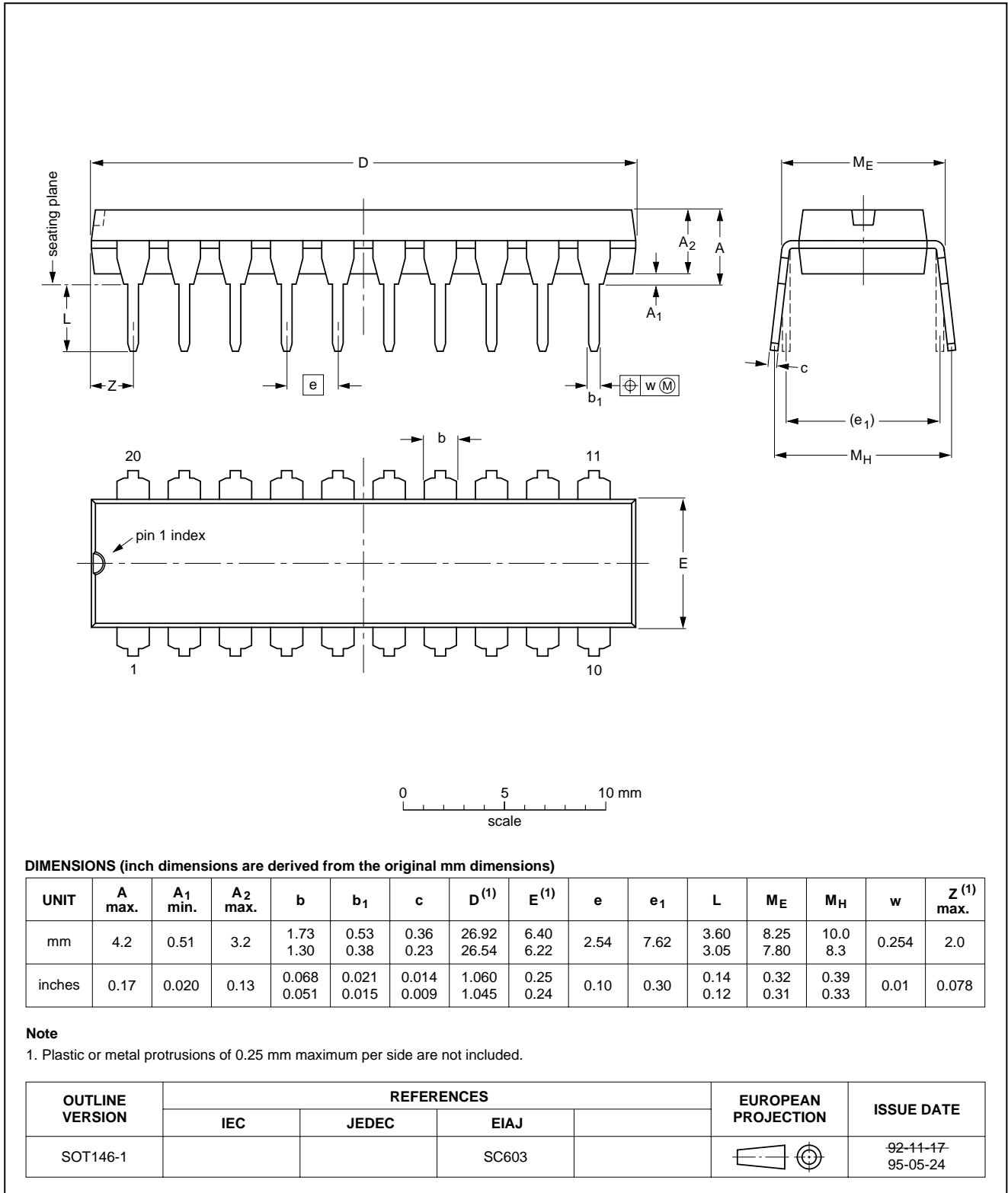

Single standard VIF-PLL demodulator
and FM-PLL detector

TDA9801

SO20: plastic small outline package; 20 leads; body width 7.5 mm

SOT163-1

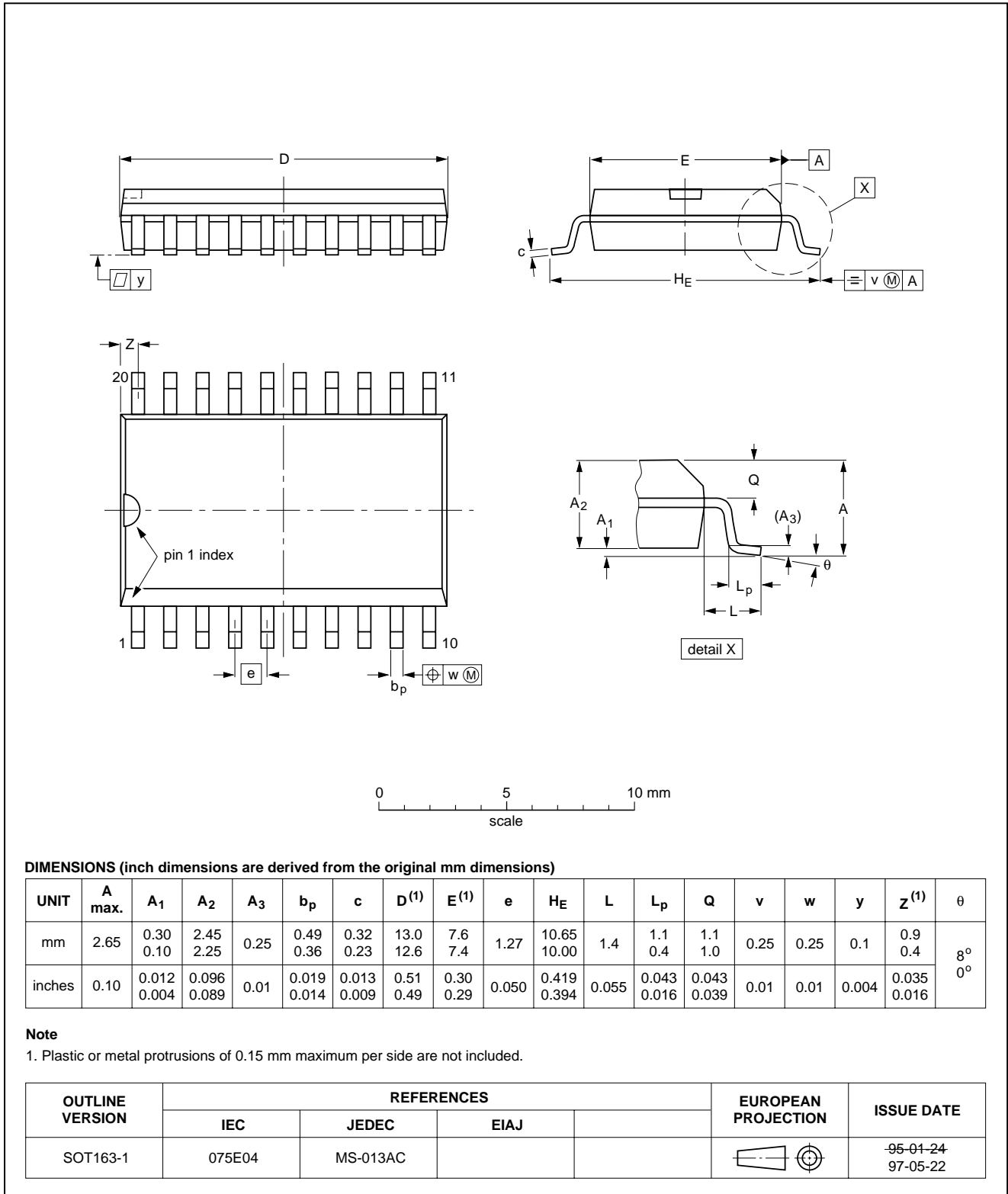

Single standard VIF-PLL demodulator and FM-PLL detector

TDA9801

SOLDERING

Introduction

This text gives a very brief insight to a complex technology. A more in-depth account of soldering ICs can be found in our "Data Handbook IC26; Integrated Circuit Packages" (document order number 9398 652 90011).

There is no soldering method that is ideal for all IC packages. Wave soldering is often preferred when through-hole and surface mount components are mixed on one printed-circuit board. However, wave soldering is not always suitable for surface mount ICs, or for printed-circuit boards with high population densities. In these situations reflow soldering is often used.

Through-hole mount packages

SOLDERING BY DIPPING OR BY SOLDER WAVE

The maximum permissible temperature of the solder is 260 °C; solder at this temperature must not be in contact with the joints for more than 5 seconds. The total contact time of successive solder waves must not exceed 5 seconds.

The device may be mounted up to the seating plane, but the temperature of the plastic body must not exceed the specified maximum storage temperature ($T_{stg(max)}$). If the printed-circuit board has been pre-heated, forced cooling may be necessary immediately after soldering to keep the temperature within the permissible limit.

MANUAL SOLDERING

Apply the soldering iron (24 V or less) to the lead(s) of the package, either below the seating plane or not more than 2 mm above it. If the temperature of the soldering iron bit is less than 300 °C it may remain in contact for up to 10 seconds. If the bit temperature is between 300 and 400 °C, contact may be up to 5 seconds.

Surface mount packages

REFLOW SOLDERING

Reflow soldering requires solder paste (a suspension of fine solder particles, flux and binding agent) to be applied to the printed-circuit board by screen printing, stencilling or pressure-syringe dispensing before package placement.

Several methods exist for reflowing; for example, infrared/convection heating in a conveyor type oven. Throughput times (preheating, soldering and cooling) vary between 100 and 200 seconds depending on heating method.

Typical reflow peak temperatures range from 215 to 250 °C. The top-surface temperature of the packages should preferably be kept below 230 °C.

WAVE SOLDERING

Conventional single wave soldering is not recommended for surface mount devices (SMDs) or printed-circuit boards with a high component density, as solder bridging and non-wetting can present major problems.

To overcome these problems the double-wave soldering method was specifically developed.

If wave soldering is used the following conditions must be observed for optimal results:

- Use a double-wave soldering method comprising a turbulent wave with high upward pressure followed by a smooth laminar wave.
- For packages with leads on two sides and a pitch (e):
 - larger than or equal to 1.27 mm, the footprint longitudinal axis is **preferred** to be parallel to the transport direction of the printed-circuit board;
 - smaller than 1.27 mm, the footprint longitudinal axis **must** be parallel to the transport direction of the printed-circuit board.

The footprint must incorporate solder thieves at the downstream end.

- For packages with leads on four sides, the footprint must be placed at a 45° angle to the transport direction of the printed-circuit board. The footprint must incorporate solder thieves downstream and at the side corners.

During placement and before soldering, the package must be fixed with a droplet of adhesive. The adhesive can be applied by screen printing, pin transfer or syringe dispensing. The package can be soldered after the adhesive is cured.

Typical dwell time is 4 seconds at 250 °C.

A mildly-activated flux will eliminate the need for removal of corrosive residues in most applications.

MANUAL SOLDERING

Fix the component by first soldering two diagonally-opposite end leads. Use a low voltage (24 V or less) soldering iron applied to the flat part of the lead. Contact time must be limited to 10 seconds at up to 300 °C.

When using a dedicated tool, all other leads can be soldered in one operation within 2 to 5 seconds between 270 and 320 °C.

Single standard VIF-PLL demodulator and FM-PLL detector

TDA9801

Suitability of IC packages for wave, reflow and dipping soldering methods

MOUNTING	PACKAGE	SOLDERING METHOD		
		WAVE	REFLOW ⁽¹⁾	DIPPING
Through-hole mount	DBS, DIP, HDIP, SDIP, SIL	suitable ⁽²⁾	–	suitable
Surface mount	BGA, SQFP	not suitable	suitable	–
	HLQFP, HSQFP, HSOP, HTQFP, HTSSOP, SMS	not suitable ⁽³⁾	suitable	–
	PLCC ⁽⁴⁾ , SO, SOJ	suitable	suitable	–
	LQFP, QFP, TQFP	not recommended ⁽⁴⁾⁽⁵⁾	suitable	–
	SSOP, TSSOP, VSO	not recommended ⁽⁶⁾	suitable	–

Notes

- All surface mount (SMD) packages are moisture sensitive. Depending upon the moisture content, the maximum temperature (with respect to time) and body size of the package, there is a risk that internal or external package cracks may occur due to vaporization of the moisture in them (the so called popcorn effect). For details, refer to the Drypack information in the “*Data Handbook IC26; Integrated Circuit Packages; Section: Packing Methods*”.
- For SDIP packages, the longitudinal axis must be parallel to the transport direction of the printed-circuit board.
- These packages are not suitable for wave soldering as a solder joint between the printed-circuit board and heatsink (at bottom version) can not be achieved, and as solder may stick to the heatsink (on top version).
- If wave soldering is considered, then the package must be placed at a 45° angle to the solder wave direction. The package footprint must incorporate solder thieves downstream and at the side corners.
- Wave soldering is only suitable for LQFP, QFP and TQFP packages with a pitch (e) equal to or larger than 0.8 mm; it is definitely not suitable for packages with a pitch (e) equal to or smaller than 0.65 mm.
- Wave soldering is only suitable for SSOP and TSSOP packages with a pitch (e) equal to or larger than 0.65 mm; it is definitely not suitable for packages with a pitch (e) equal to or smaller than 0.5 mm.

DEFINITIONS

Data sheet status	
Objective specification	This data sheet contains target or goal specifications for product development.
Preliminary specification	This data sheet contains preliminary data; supplementary data may be published later.
Product specification	This data sheet contains final product specifications.
Limiting values	
Limiting values given are in accordance with the Absolute Maximum Rating System (IEC 134). Stress above one or more of the limiting values may cause permanent damage to the device. These are stress ratings only and operation of the device at these or at any other conditions above those given in the Characteristics sections of the specification is not implied. Exposure to limiting values for extended periods may affect device reliability.	
Application information	
Where application information is given, it is advisory and does not form part of the specification.	

LIFE SUPPORT APPLICATIONS

These products are not designed for use in life support appliances, devices, or systems where malfunction of these products can reasonably be expected to result in personal injury. Philips customers using or selling these products for use in such applications do so at their own risk and agree to fully indemnify Philips for any damages resulting from such improper use or sale.

Philips Semiconductors – a worldwide company

Argentina: see South America

Australia: 3 Figtree Drive, HOMEBUSH, NSW 2140,
Tel. +61 2 9704 8141, Fax. +61 2 9704 8139

Austria: Computerstr. 6, A-1101 WIEN, P.O. Box 213,
Tel. +43 1 60 101 1248, Fax. +43 1 60 101 1210

Belarus: Hotel Minsk Business Center, Bld. 3, r. 1211, Volodarski Str. 6,
220050 MINSK, Tel. +375 172 20 0733, Fax. +375 172 20 0773

Belgium: see The Netherlands

Brazil: see South America

Bulgaria: Philips Bulgaria Ltd., Energoproject, 15th floor,
51 James Bourchier Blvd., 1407 SOFIA,
Tel. +359 2 68 9211, Fax. +359 2 68 9102

Canada: PHILIPS SEMICONDUCTORS/COMPONENTS,
Tel. +1 800 234 7381, Fax. +1 800 943 0087

China/Hong Kong: 501 Hong Kong Industrial Technology Centre,
72 Tat Chee Avenue, Kowloon Tong, HONG KONG,
Tel. +852 2319 7888, Fax. +852 2319 7700

Colombia: see South America

Czech Republic: see Austria

Denmark: Sydhavnsgade 23, 1780 COPENHAGEN V,
Tel. +45 33 29 3333, Fax. +45 33 29 3905

Finland: Sinikalliontie 3, FIN-02630 ESPOO,
Tel. +358 9 615 800, Fax. +358 9 6158 0920

France: 51 Rue Carnot, BP317, 92156 SURESNES Cedex,
Tel. +33 1 4099 6161, Fax. +33 1 4099 6427

Germany: Hammerbrookstraße 69, D-20097 HAMBURG,
Tel. +49 40 2353 60, Fax. +49 40 2353 6300

Hungary: see Austria

India: Philips INDIA Ltd, Band Box Building, 2nd floor,
254-D, Dr. Annie Besant Road, Worli, MUMBAI 400 025,
Tel. +91 22 493 8541, Fax. +91 22 493 0966

Indonesia: PT Philips Development Corporation, Semiconductors Division,
Gedung Philips, Jl. Buncit Raya Kav.99-100, JAKARTA 12510,
Tel. +62 21 794 0040 ext. 2501, Fax. +62 21 794 0080

Ireland: Newstead, Clonskeagh, DUBLIN 14,
Tel. +353 1 7640 000, Fax. +353 1 7640 200

Israel: RAPAC Electronics, 7 Kehilat Saloniki St, PO Box 18053,
TEL AVIV 61180, Tel. +972 3 645 0444, Fax. +972 3 649 1007

Italy: PHILIPS SEMICONDUCTORS, Via Casati, 23 - 20052 MONZA (MI),
Tel. +39 039 203 6838, Fax +39 039 203 6800

Japan: Philips Bldg 13-37, Kohnan 2-chome, Minato-ku,
TOKYO 108-8507, Tel. +81 3 3740 5130, Fax. +81 3 3740 5057

Korea: Philips House, 260-199 Itaewon-dong, Yongsan-ku, SEOUL,
Tel. +82 2 709 1412, Fax. +82 2 709 1415

Malaysia: No. 76 Jalan Universiti, 46200 PETALING JAYA, SELANGOR,
Tel. +60 3 750 5214, Fax. +60 3 757 4880

Mexico: 5900 Gateway East, Suite 200, EL PASO, TEXAS 79905,
Tel. +9-5 800 234 7381, Fax +9-5 800 943 0087

Middle East: see Italy

Netherlands: Postbus 90050, 5600 PB EINDHOVEN, Bldg. VB,
Tel. +31 40 27 82785, Fax. +31 40 27 88399

New Zealand: 2 Wagener Place, C.P.O. Box 1041, AUCKLAND,
Tel. +64 9 849 4160, Fax. +64 9 849 7811

Norway: Box 1, Manglerud 0612, OSLO,
Tel. +47 22 74 8000, Fax. +47 22 74 8341

Pakistan: see Singapore

Philippines: Philips Semiconductors Philippines Inc.,
106 Valero St. Salcedo Village, P.O. Box 2108 MCC, MAKATI,
Metro MANILA, Tel. +63 2 816 6380, Fax. +63 2 817 3474

Poland: Ul. Lukiska 10, PL 04-123 WARSZAWA,
Tel. +48 22 612 2831, Fax. +48 22 612 2327

Portugal: see Spain

Romania: see Italy

Russia: Philips Russia, Ul. Usatcheva 35A, 119048 MOSCOW,
Tel. +7 095 755 6918, Fax. +7 095 755 6919

Singapore: Lorong 1, Toa Payoh, SINGAPORE 319762,
Tel. +65 350 2538, Fax. +65 251 6500

Slovakia: see Austria

Slovenia: see Italy

South Africa: S.A. PHILIPS Pty Ltd., 195-215 Main Road Martindale,
2092 JOHANNESBURG, P.O. Box 58088 Newville 2114,
Tel. +27 11 471 5401, Fax. +27 11 471 5398

South America: Al. Vicente Pinzon, 173, 6th floor,
04547-130 SÃO PAULO, SP, Brazil,
Tel. +55 11 821 2333, Fax. +55 11 821 2382

Spain: Balmes 22, 08007 BARCELONA,
Tel. +34 93 301 6312, Fax. +34 93 301 4107

Sweden: Kottbygatan 7, Akalla, S-16485 STOCKHOLM,
Tel. +46 8 5985 2000, Fax. +46 8 5985 2745

Switzerland: Allmendstrasse 140, CH-8027 ZÜRICH,
Tel. +41 1 488 2741 Fax. +41 1 488 3263

Taiwan: Philips Semiconductors, 6F, No. 96, Chien Kuo N. Rd., Sec. 1,
TAIPEI, Taiwan Tel. +886 2 2134 2886, Fax. +886 2 2134 2874

Thailand: PHILIPS ELECTRONICS (THAILAND) Ltd.,
209/2 Sanpavuth-Bangna Road Prakanong, BANGKOK 10260,
Tel. +66 2 745 4090, Fax. +66 2 398 0793

Turkey: Yukari Dudullu, Org. San. Blg., 2.Cad. Nr. 28 81260 Umraniye,
ISTANBUL, Tel. +90 216 522 1500, Fax. +90 216 522 1813

Ukraine: PHILIPS UKRAINE, 4 Patrice Lumumba str., Building B, Floor 7,
252042 KIEV, Tel. +380 44 264 2776, Fax. +380 44 268 0461

United Kingdom: Philips Semiconductors Ltd., 276 Bath Road, Hayes,
MIDDLESEX UB3 5BX, Tel. +44 208 730 5000, Fax. +44 208 754 8421

United States: 811 East Arques Avenue, SUNNYVALE, CA 94088-3409,
Tel. +1 800 234 7381, Fax. +1 800 943 0087

Uruguay: see South America

Vietnam: see Singapore

Yugoslavia: PHILIPS, Trg N. Pasica 5/v, 11000 BEOGRAD,
Tel. +381 11 62 5344, Fax.+381 11 63 5777

For all other countries apply to: Philips Semiconductors,
International Marketing & Sales Communications, Building BE-p, P.O. Box 218,
5600 MD EINDHOVEN, The Netherlands, Fax. +31 40 27 24825

Internet: <http://www.semiconductors.philips.com>

© Philips Electronics N.V. 1999

SCA 67

All rights are reserved. Reproduction in whole or in part is prohibited without the prior written consent of the copyright owner.

The information presented in this document does not form part of any quotation or contract, is believed to be accurate and reliable and may be changed without notice. No liability will be accepted by the publisher for any consequence of its use. Publication thereof does not convey nor imply any license under patent- or other industrial or intellectual property rights.

Printed in The Netherlands

545004/02/pp32

Date of release: 1999 Aug 26

Document order number: 9397 750 05292

Let's make things better.

Philips
Semiconductors



PHILIPS