



## ULTRA-LOW VOLTAGE PROCESSOR SUPERVISORY CIRCUITS

### FEATURES

- Minimum Supply Voltage of 0.75 V
- Supply Voltage Supervision Range:
  - 1.2 V, 1.5 V, 1.8 V (TPS312x)
  - 3 V (TPS3125 Devices Only)
  - Other Versions on Request
- Power-On Reset Generator With Fixed Delay Time of 180 ms
- Manual Reset Input (TPS3123/5/6/8)
- Watchdog Timer Retriggeres the  $\overline{\text{RESET}}$  Output at  $V_{DD} \geq V_{IT}$
- Supply Current of 14  $\mu\text{A}$  (Typ)
- Small SOT23-5 Package
- Temperature Range of  $-40^{\circ}\text{C}$  to  $85^{\circ}\text{C}$
- Reset Output Available in Push-Pull (Active Low and High) and Open-Drain (Active-Low)

### APPLICATIONS

- Applications Using Low Voltage DSPs, Microcontrollers, or Microprocessors
- Portable/Battery-Powered Equipment
- Wireless Communication Systems
- Programmable Controls
- Industrial Equipment
- Notebook/Desktop Computers
- Intelligent Instruments

DBV PACKAGE  
(TOP VIEW)

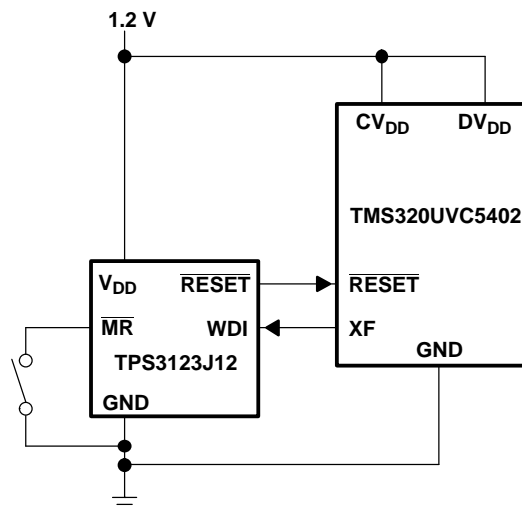
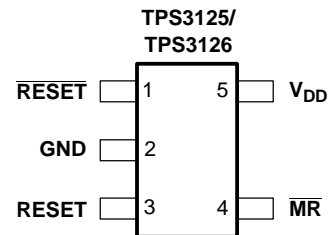
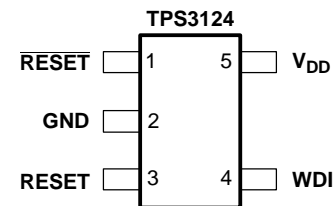
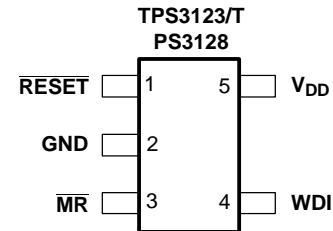

Figure 1. Typical Low-Voltage DSP Application



Please be aware that an important notice concerning availability, standard warranty, and use in critical applications of Texas Instruments semiconductor products and disclaimers thereto appears at the end of this data sheet.

## DESCRIPTION

The TPS312x family of ultralow voltage processor supervisory circuits provides circuit initialization and timing supervision, primarily for DSP and processor-based systems.

During power-on,  $\overline{\text{RESET}}$  is asserted when the supply voltage ( $V_{\text{DD}}$ ) becomes higher than 0.75 V. Thereafter, the supply voltage supervisor monitors  $V_{\text{DD}}$  and keeps  $\overline{\text{RESET}}$  output active as long as  $V_{\text{DD}}$  remains below the threshold voltage ( $V_{\text{IT}}$ ). An internal timer delays the return of the output to the inactive state (high) to ensure proper system reset. The delay time,  $t_d = 180$  ms, starts after  $V_{\text{DD}}$  has risen above the threshold voltage ( $V_{\text{IT}}$ ).

When the supply voltage drops below the threshold voltage ( $V_{\text{IT}}$ ), the output becomes active (low) again. No external components are required. All the devices of this family have a fixed-sense threshold voltage ( $V_{\text{IT}}$ ) set by a high precision internal voltage divider.

The TPS3123/5/6/8 devices incorporate a manual reset input,  $\overline{\text{MR}}$ . A low level at  $\overline{\text{MR}}$  causes  $\overline{\text{RESET}}$  to become active. The TPS3124 devices do not have the input  $\overline{\text{MR}}$ , but include a high-level output RESET same as the TPS3125 and TPS3126 devices. In addition, the TPS3123/4/8 have a watchdog timer that needs to be triggered periodically by a positive or negative transition at WDI. When the supervising system fails to retrigger the watchdog circuit within the time-out interval  $t_{\text{tout}} = 0.8$  s,  $\overline{\text{RESET}}$  output becomes active for the time period ( $t_d$ ). This event also reinitializes the watchdog timer.

The circuits are available in a 5-pin SOT23-5 package. The TPS312x devices are characterized for operation over a temperature range of  $-40^\circ\text{C}$  to  $85^\circ\text{C}$ .

### PACKAGE INFORMATION STANDARD VERSIONS<sup>(1)</sup>

$T_A$	DEVICE NAME		THRESHOLD VOLTAGE	MARKING
$-40^\circ\text{C}$ to $85^\circ\text{C}$	TPS3123J12DBVR <sup>(2)</sup>	TPS3123J12DBVT <sup>(3)</sup>	1.08 V	PBNI
	TPS3123G15DBVR <sup>(2)</sup>	TPS3123G15DBVT <sup>(3)</sup>	1.40 V	PBOI
	TPS3123J18DBVR <sup>(2)</sup>	TPS3123J18DBVT <sup>(3)</sup>	1.62 V	PBPI
	TPS3124J12DBVR <sup>(2)</sup>	TPS3124J12DBVT <sup>(3)</sup>	1.08 V	PBQI
	TPS3124G15DBVR <sup>(2)</sup>	TPS3124G15DBVT <sup>(3)</sup>	1.40 V	PBRI
	TPS3124J18DBVR <sup>(2)</sup>	TPS3124J18DBVT <sup>(3)</sup>	1.62 V	PBSI
	TPS3125J12DBVR <sup>(2)</sup>	TPS3125J12DBVT <sup>(3)</sup>	1.08 V	PBTI
	TPS3125G15DBVR <sup>(2)</sup>	TPS3125G15DBVT <sup>(3)</sup>	1.40 V	PBUI
	TPS3125J18DBVR <sup>(2)</sup>	TPS3125J18DBVT <sup>(3)</sup>	1.62 V	PBVI
	TPS3125L30DBVR <sup>(2)</sup>	TPS3125L30DBVT <sup>(3)</sup>	2.64 V	PBXI
	TPS3126E12DBVR <sup>(2)</sup>	TPS3126E12DBVT <sup>(3)</sup>	1.14 V	PFOI
	TPS3126E15DBVR <sup>(2)</sup>	TPS3126E15DBVT <sup>(3)</sup>	1.43 V	PFPI
	TPS3126E18DBVR <sup>(2)</sup>	TPS3126E18DBVT <sup>(3)</sup>	1.71 V	PFQI
	TPS3128E12DBVR <sup>(2)</sup>	TPS3128E12DBVT <sup>(3)</sup>	1.14 V	PFRI
TPS3128E15DBVR <sup>(2)</sup>	TPS3128E15DBVT <sup>(3)</sup>	1.43 V	PFSI	
TPS3128E18DBVR <sup>(2)</sup>	TPS3128E18DBVT <sup>(3)</sup>	1.71 V	PFTI	

(1) Other versions available. Contact Texas Instruments for details, minimum order quantities apply.

(2) The DBVR passive indicates tape and reel of 3000 parts.

(3) The DBVT passive indicates tape and reel of 250 parts.

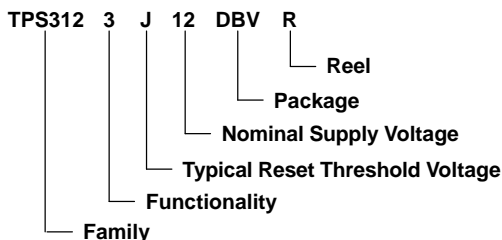

**Table 1. Ordering Information Application Specific Versions <sup>(1)</sup>**

DEVICE NAME	NOMINAL SUPPLY VOLTAGE, $V_{NOM}$	DEVICE NAME	TYPICAL RESET THRESHOLD VOLTAGE- $V_{IT}$
TPS312xx12DBV	1.2 V	TPS312xAxxDBV	$V_{NOM}$ -1%
TPS312xx15DBV	1.5 V	TPS312xBxxDBV	$V_{NOM}$ -2%
TPS312xx18DBV	1.8 V	TPS312xCxxDBV	$V_{NOM}$ -3%
TPS312xx30DBV	3.0 V	TPS312xDxxDBV	$V_{NOM}$ -4%
		TPS312xExxDBV	$V_{NOM}$ -5%
		TPS312xFxxDBV	$V_{NOM}$ -6%
		TPS312xGxxDBV	$V_{NOM}$ -7%
		TPS312xHxxDBV	$V_{NOM}$ -8%
		TPS312xIxxDBV	$V_{NOM}$ -9%
		TPS312xJxxDBV	$V_{NOM}$ -10%
		TPS312xKxxDBV	$V_{NOM}$ -11%
		TPS312xLxxDBV	$V_{NOM}$ -12%
		TPS312xMxxDBV	$V_{NOM}$ -13%
		TPS312xNxxDBV	$V_{NOM}$ -14%
		TPS312xOxxDBV	$V_{NOM}$ -15%

(1) For the application specific versions contact Texas Instruments for availability, lead time, and minimum order quantities.

**Table 2. Function Tables**

TPS3123/8			TPS3124			TPS3125/6			
MR	VDD > $V_{IT}$	RESET	VDD > $V_{IT}$	RESET	RESET	MR	VDD > $V_{IT}$	RESET	RESET
L	0	L	0	L	H	L	0	L	H
L	1	L	1	H	L	L	1	L	H
H	0	L				H	0	L	H
H	1	H				H	1	H	L

**Reset Topology**

DEVICES	OPEN DRAIN	PUSH-PULL
TPS3123		X
TPS3124		X
TPS3125		X
TPS3126	X	
TPS3128	X	

FUNCTIONAL BLOCK DIAGRAM

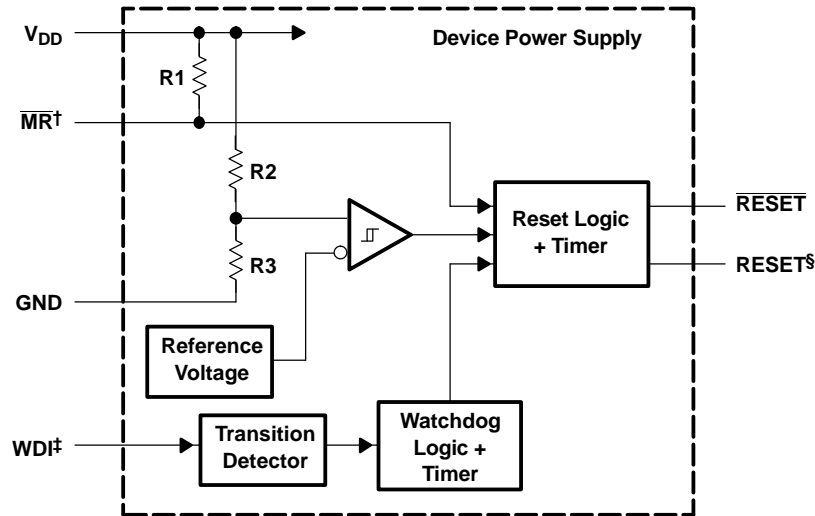

† TPS3123/5/6/8

‡ TPS3123/4/8

§ TPS3124/5/6

TIMING DIAGRAM TPS3123/5/6/8

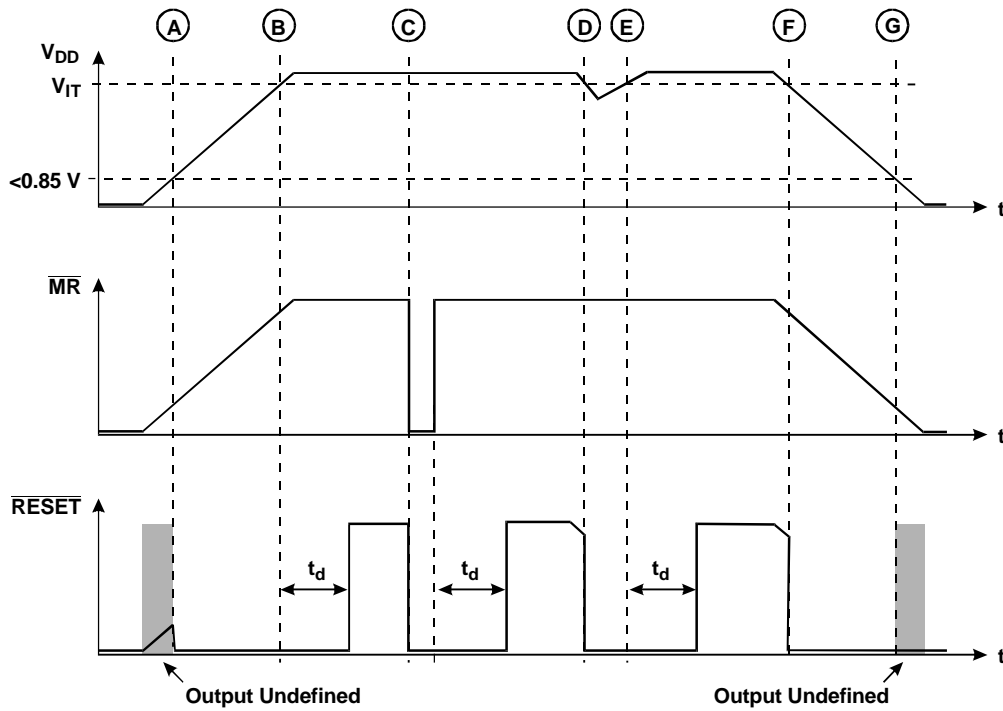

**TIMING DIAGRAM TPS3123/4//8**

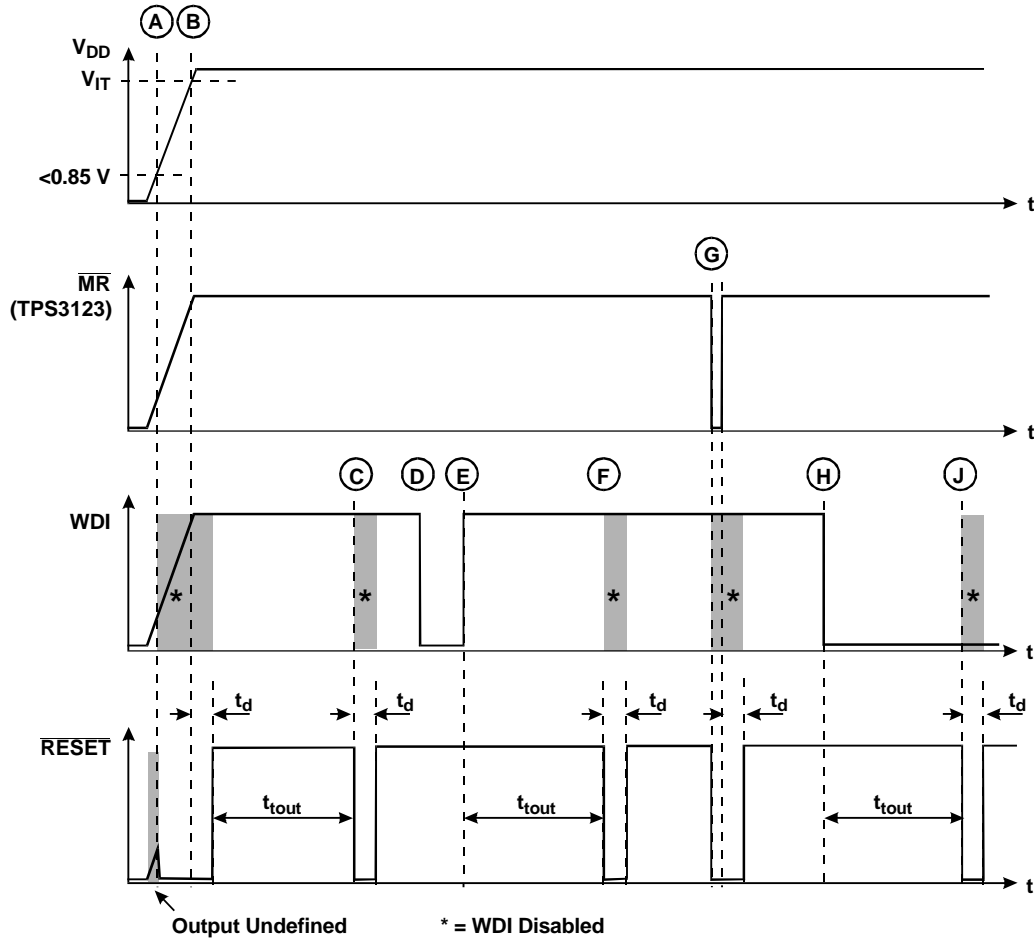

**ABSOLUTE MAXIMUM RATINGS**

over operating free-air temperature range (unless otherwise noted)<sup>(1)</sup>

	UNIT
Manual reset, $\overline{MR}$	-0.3 V to $V_{DD} + 0.6\text{ V}$
Supply voltage, $V_{DD}$	3.6 V
Watchdog input, $WDI$	-0.3 V to $V_{DD} + 6\text{ V}$
Maximum low output current, $I_{OL}$	5 mA
Maximum high output current, $I_{OH}$	-5 mA
Input clamp current, $I_{IK}$ ( $V_I < 0$ or $V_I > V_{DD}$ )	$\pm 10\text{ mA}$
Output clamp current, $I_{OK}$ ( $V_O < 0$ or $V_O > V_{DD}$ )	$\pm 10\text{ mA}$
Continuous total power dissipation	See Dissipation Rating Table
Operating free-air temperature range, $T_A$	-40°C to 85°C
Storage temperature range, $T_{stg}$	-65°C to 150°C
Soldering temperature	260°C

(1) Stresses beyond those listed under "absolute maximum ratings" may cause permanent damage to the device. These are stress ratings only, and functional operation of the device at these or any other conditions beyond those indicated under "recommended operating conditions" is not implied. Exposure to absolute-maximum-rated conditions for extended periods may affect device reliability.

### DISSIPATION RATING TABLE

PACKAGE	T <sub>A</sub> ≤ 25°C POWER RATING	DERATING FACTOR ABOVE T <sub>A</sub> = 25°C	T <sub>A</sub> = 70°C POWER RATING	T <sub>A</sub> = 85°C POWER RATING
DBV	437 mW	3.5 mW/°C	280 mW	227 mW

### RECOMMENDED OPERATING CONDITIONS

at specified temperature range

	MIN	MAX	UNIT
Supply voltage, V <sub>DD</sub>	T <sub>A</sub> = 0°C to 85°C		V
	0.75	3.3	
Manual reset voltage, V <sub>DD</sub>	T <sub>A</sub> = -40°C to 85°C		V
	0.85	3.3	
Watchdog input voltage, V <sub>WD1</sub>	0	V <sub>DD</sub> +0.3	V
High-level input voltage, V <sub>IH</sub>	0.7×V <sub>DD</sub>		V
Low-level input voltage, V <sub>IL</sub>	0.3×V <sub>DD</sub>		V
Input transition rise and fall rate at WDI, Δ t/ΔV	1		μs/V
Operating free-air temperature range, T <sub>A</sub>	40	85	°C

### ELECTRICAL CHARACTERISTICS

over recommended operating free-air temperature range (unless otherwise noted)

PARAMETER		TEST CONDITIONS	MIN	TYP	MAX	UNIT	
$\overline{\text{MR}}$ pullup resistor (internal)			27			kΩ	
I <sub>IH</sub>	High-level input current	WDI	V <sub>DD</sub> = 3.3 V			μA	
		MR	MR = 0.7 × V <sub>DD</sub> , V <sub>DD</sub> = 3.3 V				
I <sub>IL</sub>	Low-level input current	WDI	V <sub>DD</sub> = 3.3 V			μA	
		MR	MR = 0 V, V <sub>DD</sub> = 3.3 V				
I <sub>OH</sub>	High-level output current (leakage into RESET pin)	TPS3126-xx, TPS3128-xx	V <sub>DD</sub> = V <sub>OH</sub> = 3.3 V			nA	
V <sub>OH</sub>	High-level output voltage (TPS3123/4/5 only)	RESET	V <sub>DD</sub> = 1.5 V, I <sub>OH</sub> = -1 mA			0.8×V <sub>DD</sub>	V
			V <sub>DD</sub> = 3.3 V, I <sub>OH</sub> = -4.5 mA				
		RESET	V <sub>DD</sub> = 0.75 V, I <sub>OH</sub> = -8 μA				
			V <sub>DD</sub> = 1.5 V, I <sub>OH</sub> = -1 mA				
V <sub>OL</sub>	Low-level output voltage	RESET	V <sub>DD</sub> = 0.75 V, I <sub>OL</sub> = 15 μA			0.2 × V <sub>DD</sub>	V
			V <sub>DD</sub> = 1.5 V, I <sub>OL</sub> = 1.4 mA				
		RESET	V <sub>DD</sub> = 1.5 V, I <sub>OL</sub> = 1.4 mA				
			V <sub>DD</sub> = 3.3 V, I <sub>OL</sub> = 3 mA				
V <sub>IT-</sub>	Negative-going input threshold voltage <sup>(1)</sup>	TPS312xJ12	T <sub>A</sub> = -40°C to 85°C			V	
		TPS312xG15					
		TPS312xJ18					
		TPS312xL30					
		TPS312xE12					
		TPS312xE15					
		TPS312xE18					
V <sub>hys</sub>	Hysteresis at V <sub>DD</sub> input	1 V < V <sub>IT-</sub> < 1.4 V			15	mV	
		1.4 V < V <sub>IT-</sub> < 2 V			20		
		2 V < V <sub>IT-</sub> < 3 V			30		

(1) To ensure best stability of the threshold voltage, a bypass capacitor (ceramic, 0.1 μF) should be placed near the supply terminal.

## ELECTRICAL CHARACTERISTICS (continued)

over recommended operating free-air temperature range (unless otherwise noted)

PARAMETER		TEST CONDITIONS		MIN	TYP	MAX	UNIT
$I_{DD}$	Supply current	TPS3123-xx TPS3124-xx TPS3128-xx	WDI = $V_{DD}$ , $\overline{MR}$ unconnected	$V_{DD} = 0.75\text{ V}$	14		$\mu\text{A}$
				$V_{DD} = 3.3\text{ V}$	22	30	
		TPS3125-xx TPS3126-xx (2)	$\overline{MR}$ unconnected	$V_{DD} = 0.75\text{ V}$	14		
				$V_{DD} = 3.3\text{ V}$	18	25	
$C_i$	Input capacitance at $\overline{MR}$ , WDI	$V_i = 0\text{ V to } 3.3\text{ V}$		5			pF

(2) The supply current during delay time  $t_d$  is typical 5  $\mu\text{A}$  higher.

## TIMING REQUIREMENTS

at  $R_L = 1\text{ M}\Omega$ ,  $C_L = 50\text{ pF}$ ,  $T_A = 25^\circ\text{C}$

PARAMETER		TEST CONDITIONS			MIN	TYP	MAX	UNIT
$t_w$	Pulse width	At $V_{DD}$	$V_{IH} = V_{IT-} + 0.2\text{ V}$ , $V_{IL} = V_{IT-} - 0.2\text{ V}$		6			$\mu\text{s}$
		At $\overline{MR}$	$V_{DD} \geq V_{IT-} + 0.2\text{ V}$ , $V_{IL} = 0.3 \times V_{DD}$ , $V_{IH} = 0.7 \times V_{DD}$		1			
		At WDI			0.1			

## SWITCHING CHARACTERISTICS

at  $R_L = 1\text{ M}\Omega$ ,  $C_L = 50\text{ pF}$ ,  $T_A = 25^\circ\text{C}$

PARAMETER		TEST CONDITIONS		MIN	TYP	MAX	UNIT
$t_{\text{tout}}$	Watchdog time out	$V_{DD} \geq V_{IT-} + 0.2\text{ V}$ , See timing diagram		0.8	1.4	2.1	s
$t_d$	Delay time	$V_{DD} > V_{IT-} + 0.2\text{ V}$ , See timing diagram		100	180	260	ms
$t_{\text{PHL}}$	Propagation delay time, high-to-low-level output	$\overline{MR}$ to RESET delay (TPS3123/5/6/8)	$V_{DD} \geq V_{IT-} + 0.2\text{ V}$ , $V_{IL} = 0.2 \times V_{DD}$ , $V_{IH} = 0.8 \times V_{DD}$			0.1	$\mu\text{s}$
$t_{\text{PLH}}$	Propagation delay time, low-to-high-level output	$\overline{MR}$ to RESET delay (TPS3125/6)				0.1	
$t_{\text{PHL}}$	Propagation delay time, high-to-low-level output	$V_{DD}$ to RESET delay	$V_{IL} = V_{IT-} - 0.2\text{ V}$ , $V_{IH} = V_{IT-} + 0.2\text{ V}$			10	$\mu\text{s}$
$t_{\text{PLH}}$	Propagation delay time, low-to-high-level output	$V_{DD}$ to RESET delay (TPS3124/5/6)				10	

TYPICAL CHARACTERISTICS

SUPPLY CURRENT  
 vs  
 SUPPLY VOLTAGE

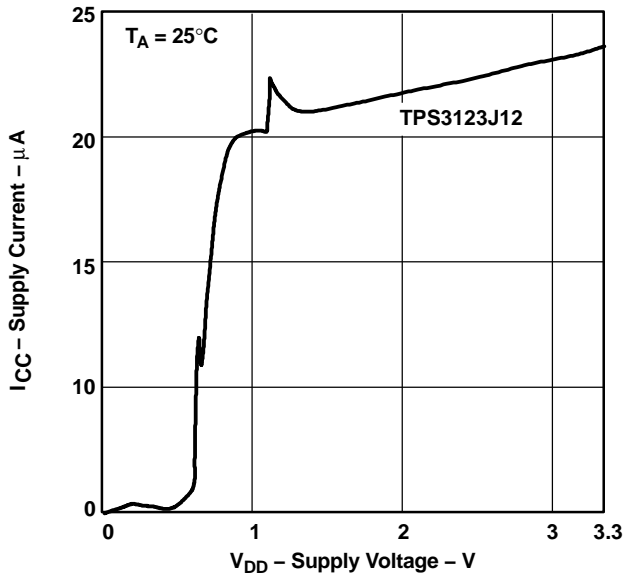

Figure 2.

LOW-LEVEL OUTPUT VOLTAGE  
 vs  
 LOW-LEVEL OUTPUT CURRENT

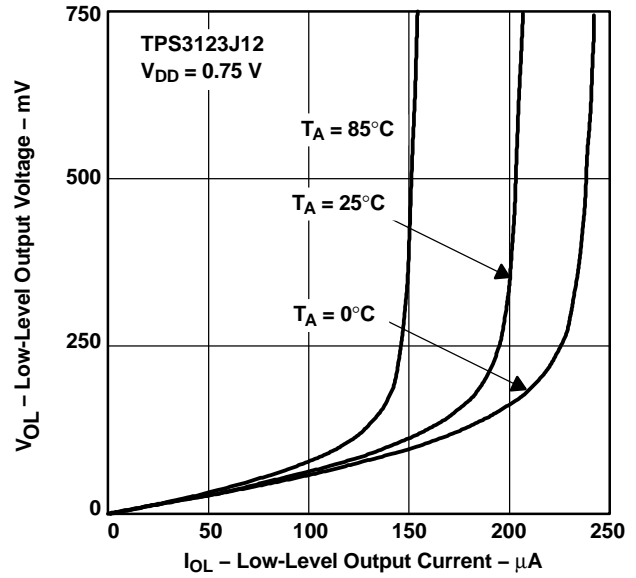

Figure 3.

LOW-LEVEL OUTPUT VOLTAGE  
 vs  
 LOW-LEVEL OUTPUT CURRENT

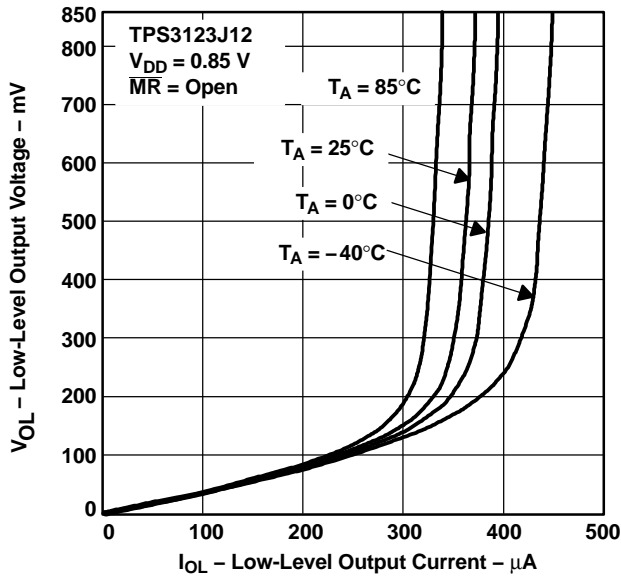

Figure 4.

LOW-LEVEL OUTPUT VOLTAGE  
 vs  
 LOW-LEVEL OUTPUT CURRENT

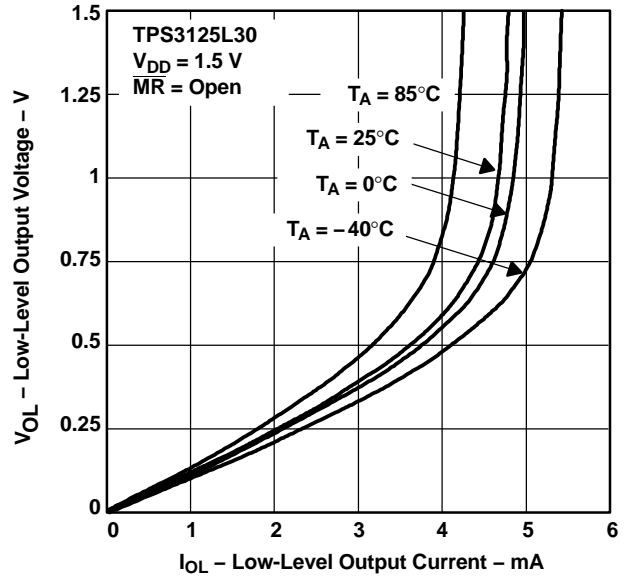

Figure 5.



**TYPICAL CHARACTERISTICS (continued)**

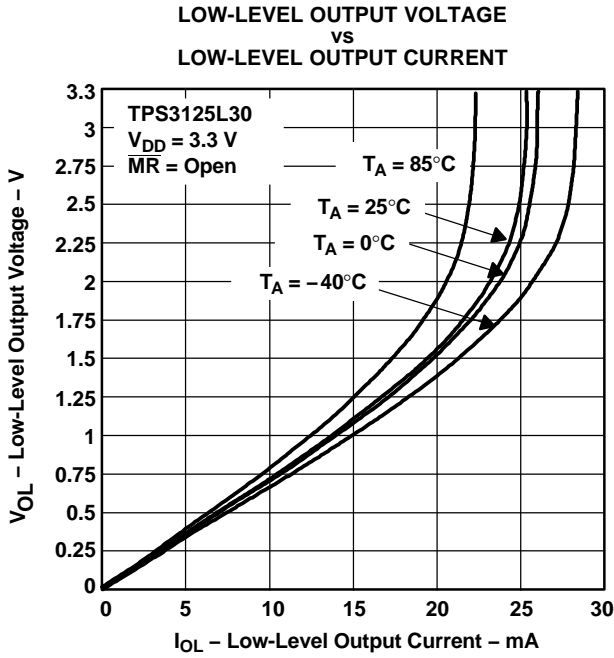

Figure 6.

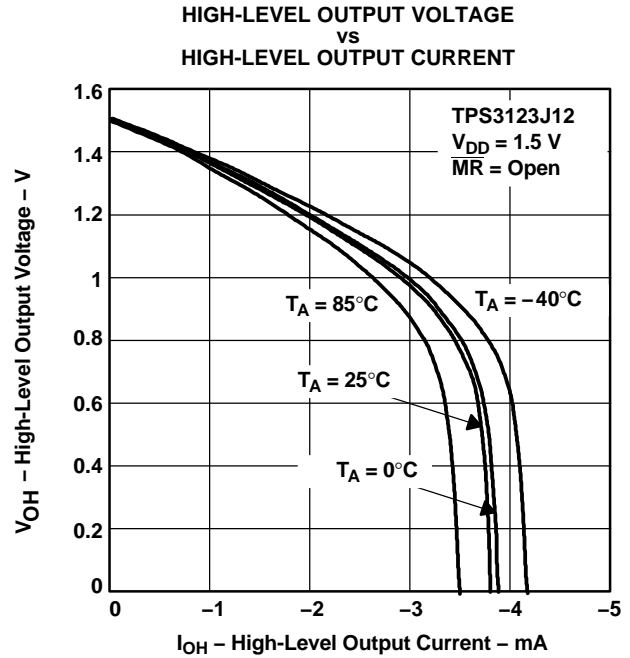

Figure 7.

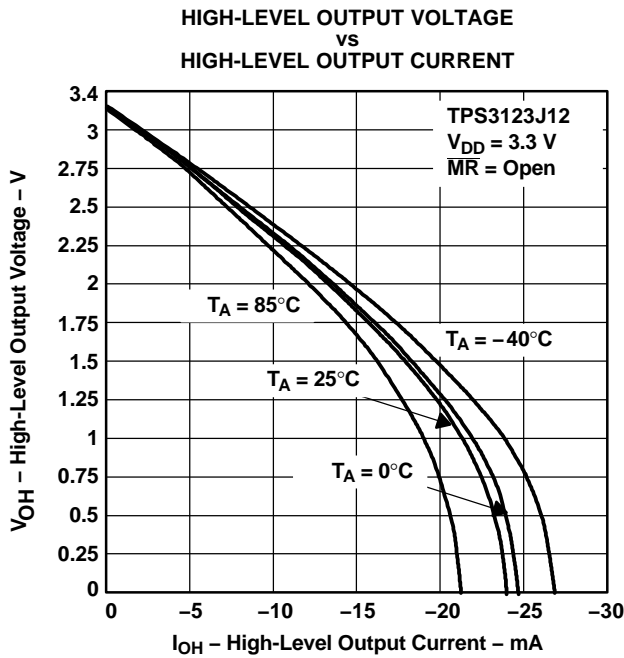

Figure 8.

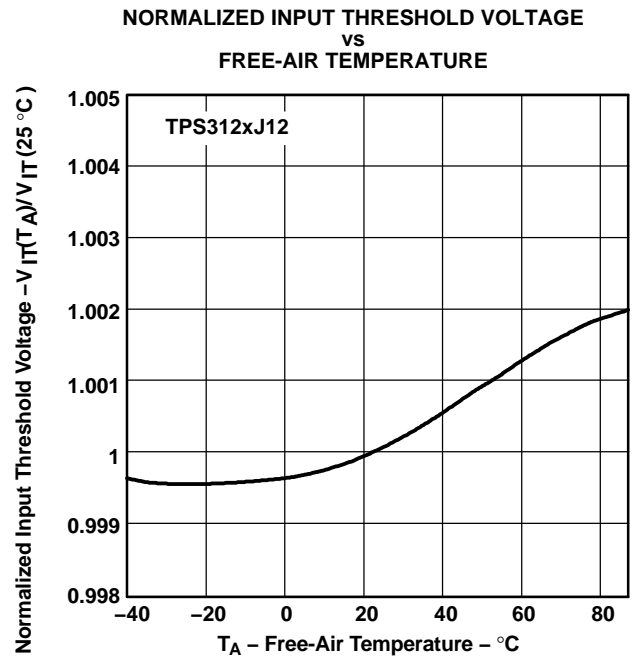

Figure 9.

TYPICAL CHARACTERISTICS (continued)

NORMALIZED INPUT THRESHOLD VOLTAGE  
 vs  
 FREE-AIR TEMPERATURE

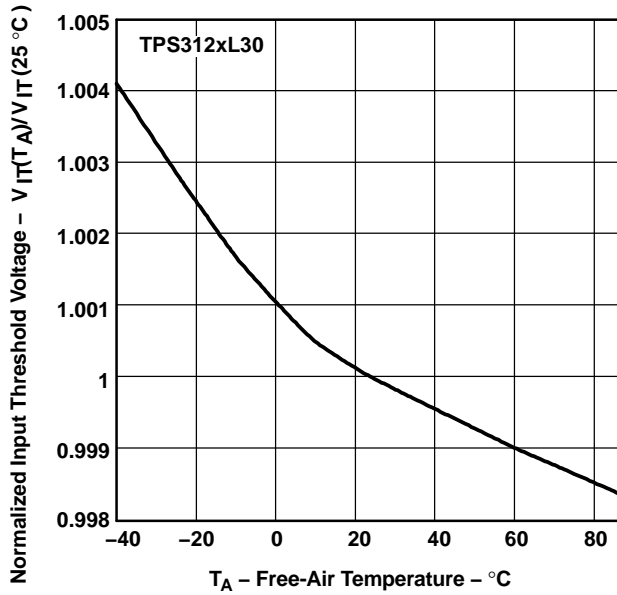

Figure 10.

MINIMUM PULSE DURATION  
 vs  
 THRESHOLD OVERDRIVE

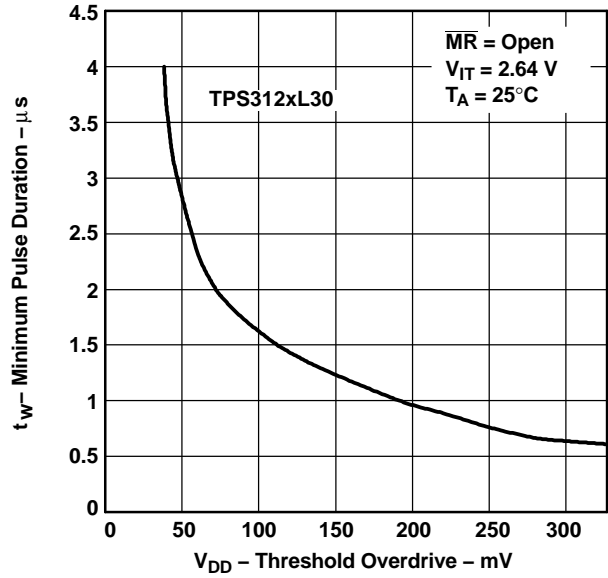

Figure 11.

MINIMUM PULSE DURATION  
 vs  
 THRESHOLD OVERDRIVE

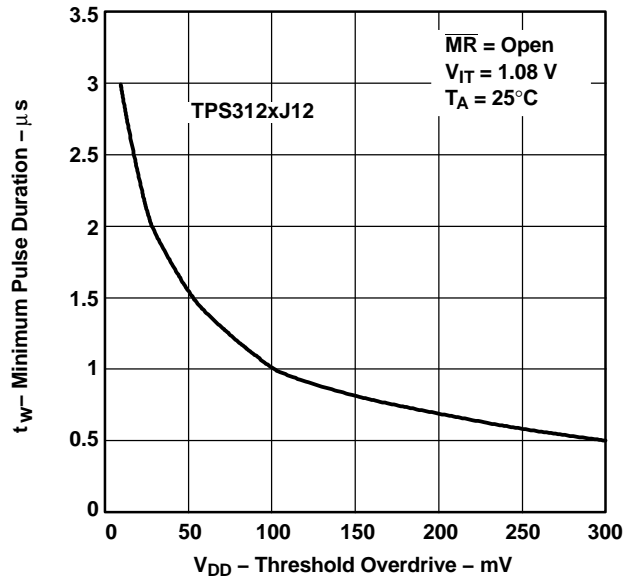

Figure 12.



## IMPORTANT NOTICE

Texas Instruments Incorporated and its subsidiaries (TI) reserve the right to make corrections, modifications, enhancements, improvements, and other changes to its products and services at any time and to discontinue any product or service without notice. Customers should obtain the latest relevant information before placing orders and should verify that such information is current and complete. All products are sold subject to TI's terms and conditions of sale supplied at the time of order acknowledgment.

TI warrants performance of its hardware products to the specifications applicable at the time of sale in accordance with TI's standard warranty. Testing and other quality control techniques are used to the extent TI deems necessary to support this warranty. Except where mandated by government requirements, testing of all parameters of each product is not necessarily performed.

TI assumes no liability for applications assistance or customer product design. Customers are responsible for their products and applications using TI components. To minimize the risks associated with customer products and applications, customers should provide adequate design and operating safeguards.

TI does not warrant or represent that any license, either express or implied, is granted under any TI patent right, copyright, mask work right, or other TI intellectual property right relating to any combination, machine, or process in which TI products or services are used. Information published by TI regarding third-party products or services does not constitute a license from TI to use such products or services or a warranty or endorsement thereof. Use of such information may require a license from a third party under the patents or other intellectual property of the third party, or a license from TI under the patents or other intellectual property of TI.

Reproduction of information in TI data books or data sheets is permissible only if reproduction is without alteration and is accompanied by all associated warranties, conditions, limitations, and notices. Reproduction of this information with alteration is an unfair and deceptive business practice. TI is not responsible or liable for such altered documentation.

Resale of TI products or services with statements different from or beyond the parameters stated by TI for that product or service voids all express and any implied warranties for the associated TI product or service and is an unfair and deceptive business practice. TI is not responsible or liable for any such statements.

Following are URLs where you can obtain information on other Texas Instruments products and application solutions:

<b>Products</b>		<b>Applications</b>	
Amplifiers	<a href="http://amplifier.ti.com">amplifier.ti.com</a>	Audio	<a href="http://www.ti.com/audio">www.ti.com/audio</a>
Data Converters	<a href="http://dataconverter.ti.com">dataconverter.ti.com</a>	Automotive	<a href="http://www.ti.com/automotive">www.ti.com/automotive</a>
DSP	<a href="http://dsp.ti.com">dsp.ti.com</a>	Broadband	<a href="http://www.ti.com/broadband">www.ti.com/broadband</a>
Interface	<a href="http://interface.ti.com">interface.ti.com</a>	Digital Control	<a href="http://www.ti.com/digitalcontrol">www.ti.com/digitalcontrol</a>
Logic	<a href="http://logic.ti.com">logic.ti.com</a>	Military	<a href="http://www.ti.com/military">www.ti.com/military</a>
Power Mgmt	<a href="http://power.ti.com">power.ti.com</a>	Optical Networking	<a href="http://www.ti.com/opticalnetwork">www.ti.com/opticalnetwork</a>
Microcontrollers	<a href="http://microcontroller.ti.com">microcontroller.ti.com</a>	Security	<a href="http://www.ti.com/security">www.ti.com/security</a>
		Telephony	<a href="http://www.ti.com/telephony">www.ti.com/telephony</a>
		Video & Imaging	<a href="http://www.ti.com/video">www.ti.com/video</a>
		Wireless	<a href="http://www.ti.com/wireless">www.ti.com/wireless</a>

Mailing Address: Texas Instruments  
Post Office Box 655303 Dallas, Texas 75265