

STS521XXBXXX

TVS Diode ESD suppressor



Product features

- Compact package size 0.063" x 0.032" (1.6 mm x 0.8 mm)
- Protects one bi-directional I/O line
- Low clamping voltage
- Meets moisture sensitivity level (MSL) 3
- Molding compound flammability rating: UL 94V-0
- Termination finish: Tin

Applications

- Cellular handsets and accessories
- Microprocessor based equipment
- Portable electronics
- Notebooks, desktops, and servers
- Portable instrumentation
- Peripherals
- Digital cameras

Environmental compliance and general specifications

- IEC61000-4-2 (ESD)
 - Up to ±30 kV (air)
 - Up to ±30 kV (contact)
- IEC61000-4-5 (Lightning) Up to 20 A (8/20 μs)



Ordering part number

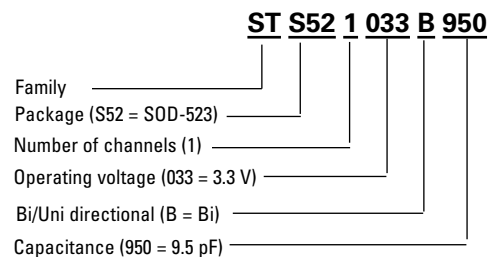

Pin out/functional diagram



SOD-523

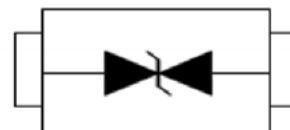

Pin Configuration

Absolute maximum ratings

(+25 °C, RH=45%-75%, unless otherwise noted)

Parameter	Symbol	Value					Unit
		STS521050BL90	STS521050B250	STS521050B750	STS521033B950	STS521050B331	
Peak pulse power dissipation on 8/20 μs waveform	P_{PP}	20	40	100	60	350	W
ESD per IEC 61000-4-2 (Air)	V_{ESD}	+/-15	+/-20	+/-30	+/-30	+/-25	kV
ESD per IEC 61000-4-2 (Contact)		+/-8	+/-15	+/-30	+/-25	+/-20	
Lead soldering temperature	T_L	+260 (10 seconds)					°C
Operating junction temperature range	T_J	-55 to +125					°C
Storage temperature range	T_{STG}	-55 to +150					°C

Electrical characteristics

(+25 °C)

STS521050BL90

Parameter	Test condition	Minimum	Typical	Maximum	Symbol (Units)
Reverse working voltage	-	-	-	5.0	V_{RWM} (V)
Reverse breakdown voltage	$I_T = 1$ mA	6.0	-	-	V_{BR} (V)
Reverse leakage current	$V_{RWM} = 5$ V	-	-	1	I_R (μA)
Clamping voltage	$I_{PP} = 1$ A, $t_p = 8/20$ μs	-	-	13	V_C (V)
Junction capacitance	$V_{RWM} = 0$ V, $f = 1$ MHz	-	0.9	1.5	C_J (pF)

STS521050B250

Parameter	Test condition	Minimum	Typical	Maximum	Symbol (Units)
Reverse working voltage	-	-	-	5.0	V_{RWM} (V)
Reverse breakdown voltage	$I_T = 1$ mA	6.0	-	-	V_{BR} (V)
Reverse holding voltage	-	-	-	0.15	V_R (V)
Reverse leakage current	$V_{RWM} = 5$ V	-	-	2	I_R (μA)
Clamping voltage	$I_{PP} = 2$ A, $t_p = 8/20$ μs	-	12.5	13.5	V_C (V)
Junction capacitance	$V_{RWM} = 0$ V, $f = 1$ MHz	-	2.5	4	C_J (pF)

STS521050B750

Parameter	Test condition	Minimum	Typical	Maximum	Symbol (Units)
Reverse working voltage	-	-	-	5.0	V_{RWM} (V)
Reverse breakdown voltage	$I_T = 1$ mA	5.5	-	-	V_{BR} (V)
Reverse holding voltage	$I_H = 50$ mA	5.5	-	-	V_R (V)
Reverse leakage current	$V_{RWM} = 5$ V	-	-	0.1	I_R (μ A)
Clamping voltage	$I_{pp} = 1$ A, $t_p = 8/20$ μ s	-	9	10	V_C (V)
	$I_{pp} = 5$ A, $t_p = 8/20$ μ s	-	13	15.5	V_C (V)
Junction capacitance	$V_{RWM} = 0$ V, $f = 1$ MHz	-	7.5	15	C_J (pF)

STS521033B950

Parameter	Test condition	Minimum	Typical	Maximum	Symbol (Units)
Reverse working voltage	-	-	-	3.3	V_{RWM} (V)
Reverse breakdown voltage	$I_T = 1$ mA	3.6	-	-	V_{BR} (V)
Reverse holding voltage	$I_H = 50$ mA	3.5	-	-	V_R (V)
Reverse leakage current	$V_{RWM} = 3.3$ V	-	-	1	I_R (μ A)
Clamping voltage	$I_{pp} = 1$ A, $t_p = 8/20$ μ s	-	6	8	V_C (V)
	$I_{pp} = 4.5$ A, $t_p = 8/20$ μ s	-	9	12	V_C (V)
Junction capacitance	$V_{RWM} = 0$ V, $f = 1$ MHz	-	9.5	15	C_J (pF)

STS521050B331

Parameter	Test condition	Minimum	Typical	Maximum	Symbol (Units)
Reverse working voltage	-	-	-	5.0	V_{RWM} (V)
Reverse breakdown voltage	$I_T = 1$ mA	5.5	-	-	V_{BR} (V)
Reverse leakage current	$V_{RWM} = 5$ V	-	-	1	I_R (μ A)
Clamping voltage	$I_{pp} = 1$ A, $t_p = 8/20$ μ s	-	7.5	9.0	V_C (V)
	$I_{pp} = 20$ A, $t_p = 8/20$ μ s	-	12	18	V_C (V)
Junction capacitance	$V_{RWM} = 0$ V, $f = 1$ MHz	-	33	75	C_J (pF)

Mechanical parameters, pad layout- mm/inches

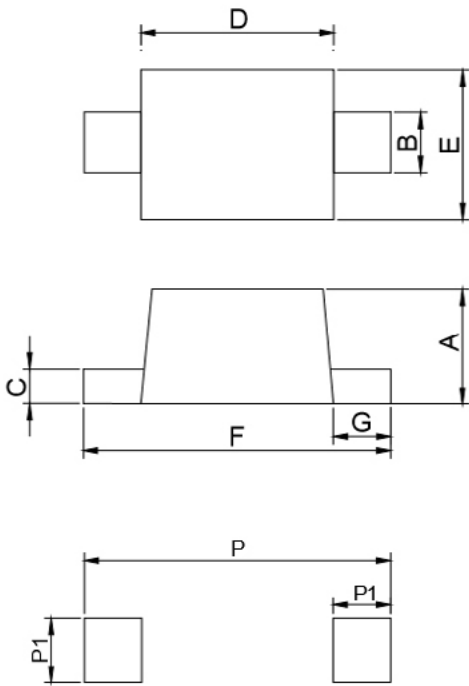

Land Pattern

Dimension	Millimeters		Inches	
	Minimum	Maximum	Minimum	Maximum
A	0.50	0.70	0.020	0.028
B	0.25	0.35	0.010	0.014
C	0.07	0.20	0.0028	0.0079
D	1.10	1.30	0.043	0.051
E	0.70	0.90	0.028	0.035
F	1.50	1.70	0.059	0.067
G	0.15	0.25	0.006	0.010
P1	0.40		0.016	
P	1.80		0.072	

Part marking

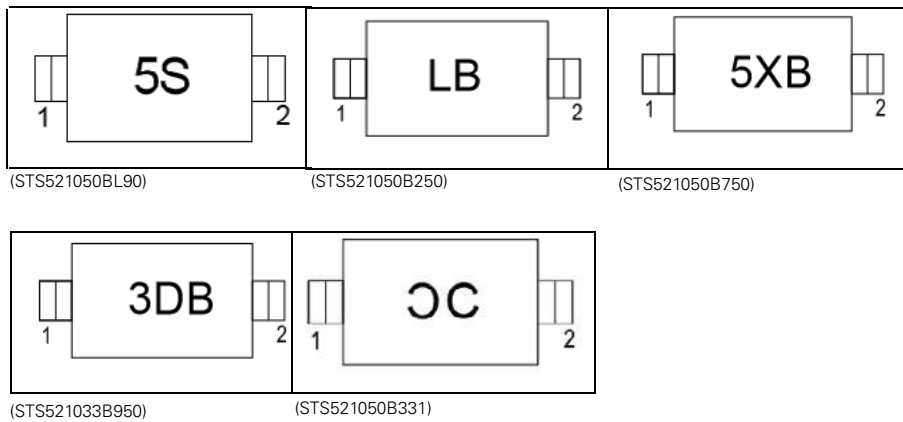

Packaging information mm/inches

Drawing not to scale.

Supplied in tape and reel packaging, 5,000 parts per 7" diameter reel (EIA-481 compliant)

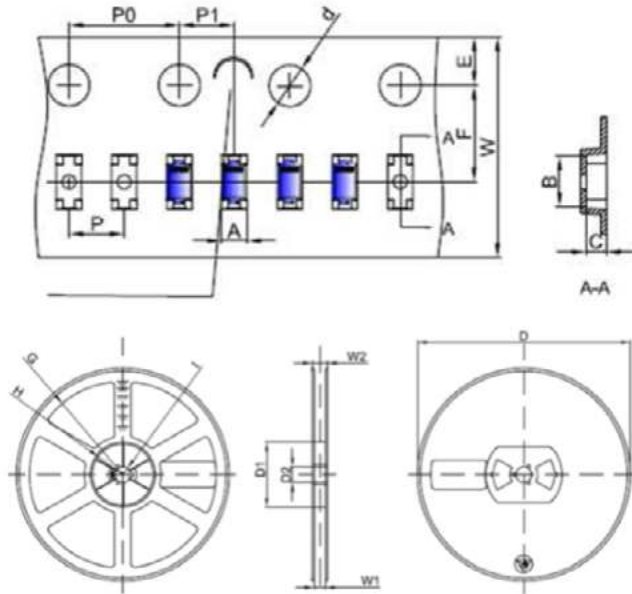

Symbol	Millimeter	Inches
	Typ.	Typ.
A	0.90	0.035
B	1.94	0.076
C	0.73	0.029
d	Φ1.50	Φ0.059
E	1.75	0.069
F	3.50	0.138
P0	4.00	0.157
P	2.00	0.079
P1	2.00	0.079
W	8.00	0.315
D	Φ178	Φ7.008
D1	54.40	2.142
D2	13.00	0.512
G	R78.00	R3.071
H	R25.60	R1.008
I	R6.50	R0.256
W1	9.50	0.374
W2	12.30	0.484

Ratings and V-I characteristic curves (+25 °C unless otherwise noted)

V- I curve characteristics (Bi-directional)

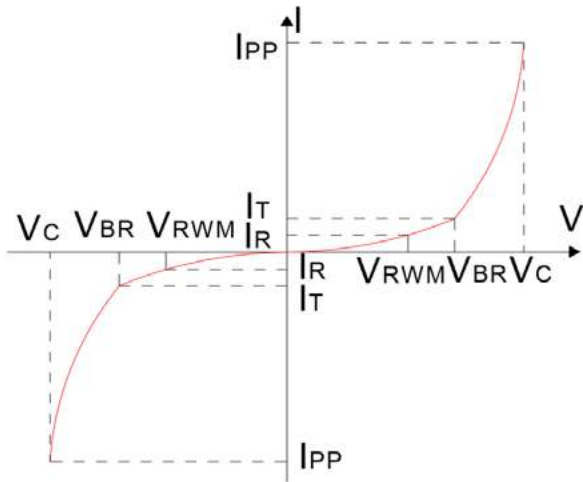

Pulse waveform (8/20 μ s)

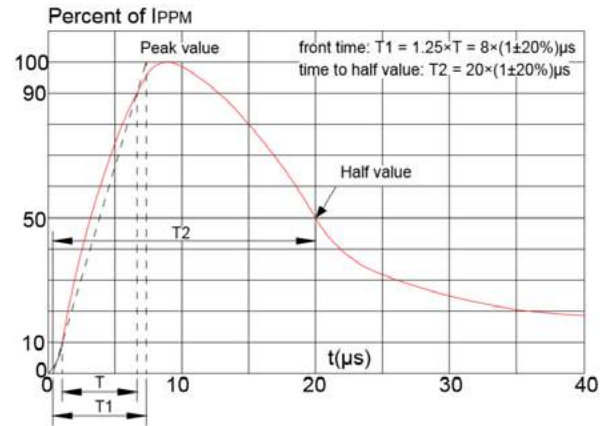

Pulse derating curve

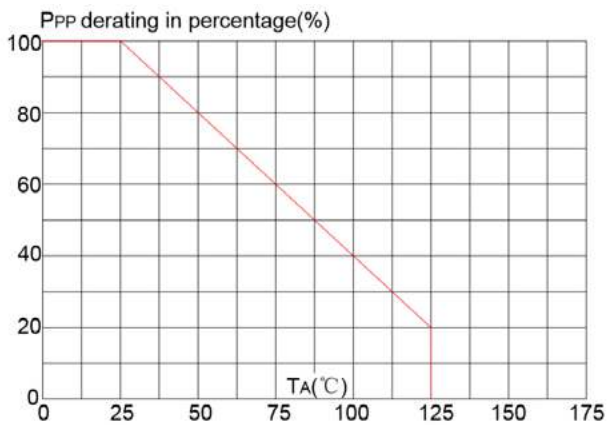

ESD waveform

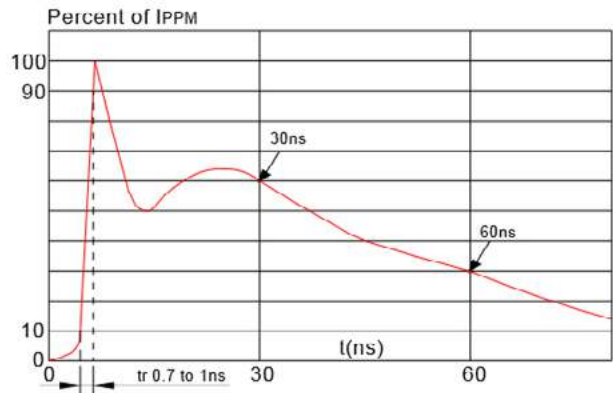

Solder reflow profile

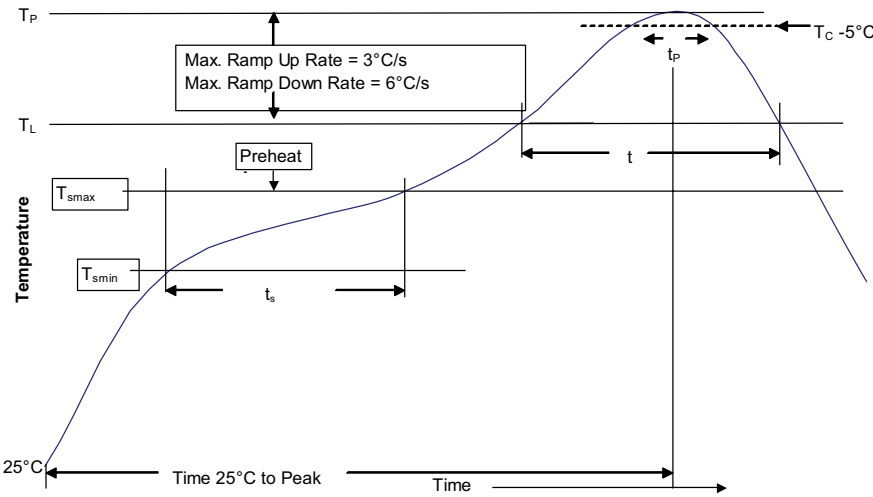

Table 1 - Standard SnPb solder (T_C)

Package thickness	Volume mm ³ <350	Volume mm ³ ≥350
<2.5 mm	235 °C	220 °C
≥2.5 mm	220 °C	220 °C

Table 2 - Lead (Pb) free solder (T_C)

Package thickness	Volume mm ³ <350	Volume mm ³ 350 - 2000	Volume mm ³ >2000
<1.6 mm	260 °C	260 °C	260 °C
1.6 – 2.5 mm	260 °C	250 °C	245 °C
>2.5 mm	250 °C	245 °C	245 °C

Reference J-STD-020

Profile feature	Standard SnPb solder	Lead (Pb) free solder
Preheat and soak		
• Temperature min. (T _{smin})	100 °C	150 °C
• Temperature max. (T _{smax})	150 °C	200 °C
• Time (T _{smin} to T _{smax}) (t _s)	60-120 seconds	60-120 seconds
Ramp up rate T _L to T _p	3 °C/ second max.	3 °C/ second max.
Liquidous temperature (T _L)	183 °C	217 °C
Time (t _L) maintained above T _L	60-150 seconds	60-150 seconds
Peak package body temperature (T _p)*	Table 1	Table 2
Time (t _p)* within 5 °C of the specified classification temperature (T _C)	20 seconds*	30 seconds*
Ramp-down rate (T _p to T _L)	6 °C/ second max.	6 °C/ second max.
Time 25 °C to peak temperature	6 minutes max.	8 minutes max.

* Tolerance for peak profile temperature (T_p) is defined as a supplier minimum and a user maximum.

Life Support Policy: Eaton does not authorize the use of any of its products for use in life support devices or systems without the express written approval of an officer of the Company. Life support systems are devices which support or sustain life, and whose failure to perform, when properly used in accordance with instructions for use provided in the labeling, can be reasonably expected to result in significant injury to the user.

Eaton reserves the right, without notice, to change design or construction of any products and to discontinue or limit distribution of any products. Eaton also reserves the right to change or update, without notice, any technical information contained in this bulletin.

Eaton
Electronics Division
1000 Eaton Boulevard
Cleveland, OH 44122
United States
Eaton.com/electronics

© 2020 Eaton
All Rights Reserved
Printed in USA
Publication No. 11153 BU-MC20135
September 2020

Eaton is a registered trademark.
All other trademarks are property of their respective owners.

Follow us on social media to get the latest product and support information.

