

SPECIFICATIONS CDSX30 SERIES
PACKAGE DIMENSIONS

CDSC30 SERIES
CDSA30 SERIES

Notes:

1. All dimensions are in millimeters (inches).
2. Tolerance is $\pm 0.25\text{mm}$ (0.01") unless otherwise noted.
3. Specifications are subject to change without notice.

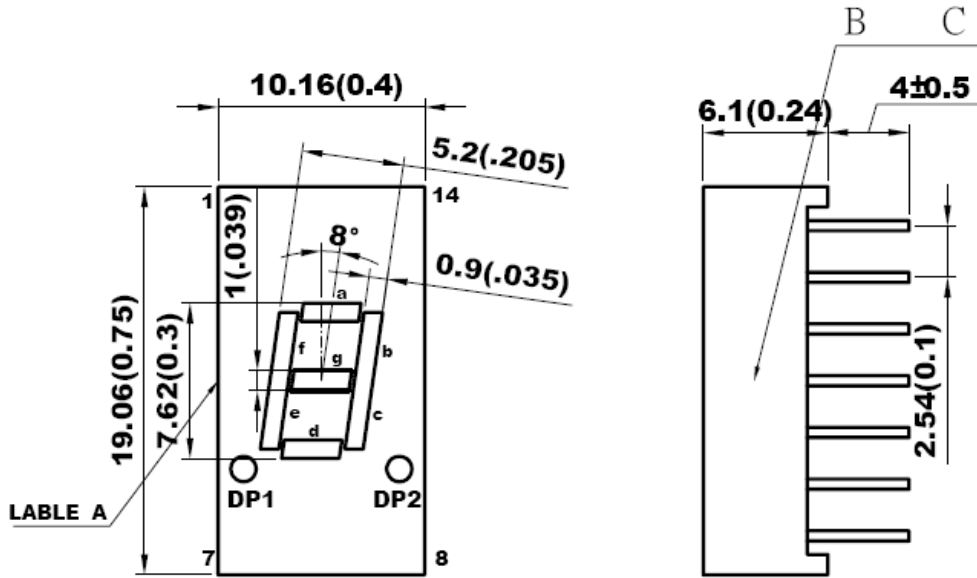
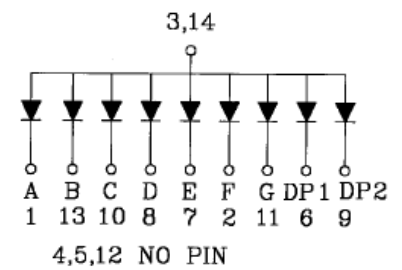
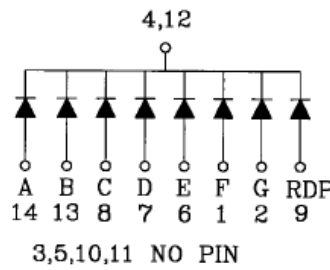
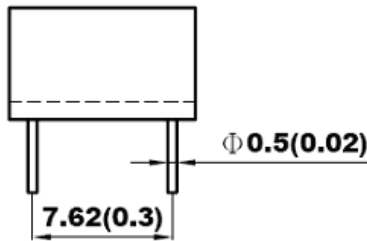

ChromeLED Corp. reserves the right to make changes at any time in order to supply the best product possible. The most current version of this document will always be available at: www.chromeled.com

PART NUMBER DESCRIPTION

Part Number	Chip Material	Color of Emission	Lens Type	Description
CDSA30R1W	GaAsP	Red	White Segment	Common Anode
CDSC30R1W	GaAsP	Red	White Segment	Common Cathode
CDSA30RR1W	AlGaAs	Super Red	White Segment	Common Anode
CDSC30RR1W	AlGaAs	Super Red	White Segment	Common Cathode
CDSA30Y1W	GaAsP	Yellow	White Segment	Common Anode
CDSC30Y1W	GaAsP	Yellow	White Segment	Common Cathode
CDSA30G1W	GaP	Green	White Segment	Common Anode
CDSC30G1W	GaP	Green	White Segment	Common Cathode
CDSA30B1W	GaN	Blue	White Segment	Common Anode
CDSC30B1W	GaN	Blue	White Segment	Common Cathode

OPTICAL-ELECTRICAL CHARACTERISTICS
(TA=25°C)

Part Number	Wave-length (nm)	Absolute Maximum				Electro-Optical Characteristics					
		$\Delta\lambda$	P _D	I _{AF}	I _{PF}	V _F (V)			I _F	I _v (μcd)	
		nm	mW	mA	(Peak)	Min	Typ	Max	(Rec)	Min	Typ
CDSA30R1W	625	45	75	30	100	1.7	1.85	2.5	10	1200	6400
CDSC30R1W	625	45	75	30	100	1.7	1.85	2.5	10	1200	6400
CDSA30RR1W	640	20	72	20	100	1.6	1.75	2.4	10	12000	26000
CDSC30RR1W	640	20	72	20	100	1.6	1.75	2.4	10	12000	26000
CDSA30Y1W	588	35	75	30	100	1.7	2.1	2.8	10	800	3000
CDSC30Y1W	588	35	75	30	100	1.7	2.1	2.8	10	800	3000
CDSA30G1W	568	30	65	30	100	1.7	2.1	2.8	10	1900	8000
CDSC30G1W	568	30	65	30	100	1.7	2.1	2.8	10	1900	8000
CDSA30B1W	470	30	120	30	100	3.0	3.5	4.0	10	4500	8500
CDSC30B1W	470	30	120	30	100	3.0	3.5	4.0	10	4500	8500



ChromeLED Corp. reserves the right to make changes at any time in order to supply the best product possible. The most current version of this document will always be available at: www.chromeled.com

ABSOLUTE MAXIMUM RATINGS (TA=25°C)

Reverse Voltage	5V	Spectral Line half-width (λ)	nm
Reverse Current (Vr = 5V)	100 μ A	Power Dissipation (Pd)	mW
Operating Temperature	-40°C~+85°C	Peak Forward Current (Duty 1/10, @ KHz)	mA
Storage Temperature	-40°C~+85°C	Recommended Operation Current (If Rec)	mA
Soldering Temperature	250C~260C for 3 sec.	Average Luminous Intensity (If=10)	μ A



ChromeLED Corp. reserves the right to make changes at any time in order to supply the best product possible. The most current version of this document will always be available at: www.chromeled.com

OPTICAL CHARACTERISTIC CURVES - RED

Forward Current vs. Forward Voltage

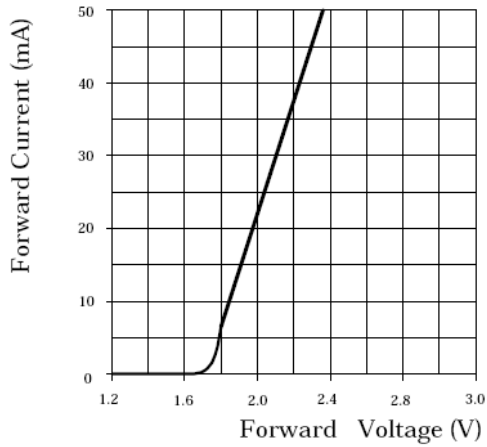

Relative Intensity vs. Forward Current

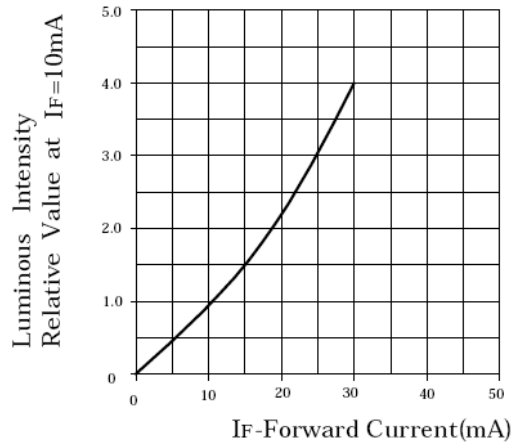

Forward Current vs. Ambient Temperature

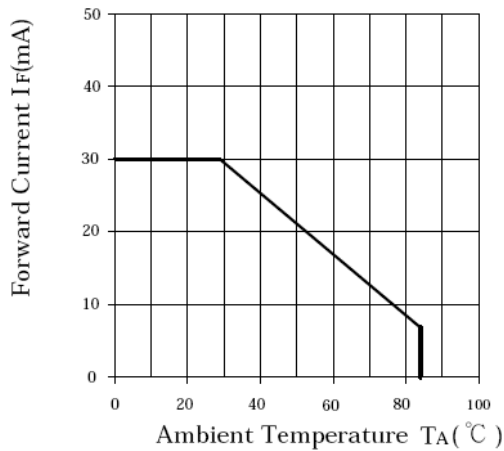

Luminous Intensity vs. Ambient Temperature

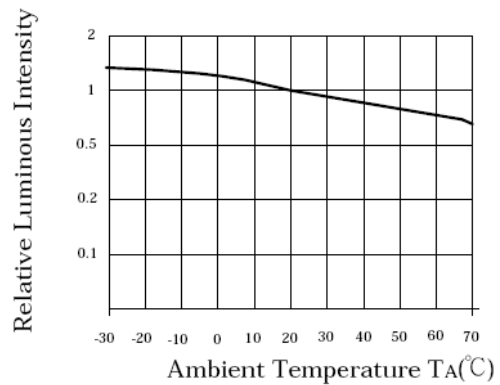

ChromeLED Corp. reserves the right to make changes at any time in order to supply the best product possible. The most current version of this document will always be available at: www.chromeled.com

OPTICAL CHARACTERISTIC CURVES - SUPER RED

Forward Current vs. Forward Voltage

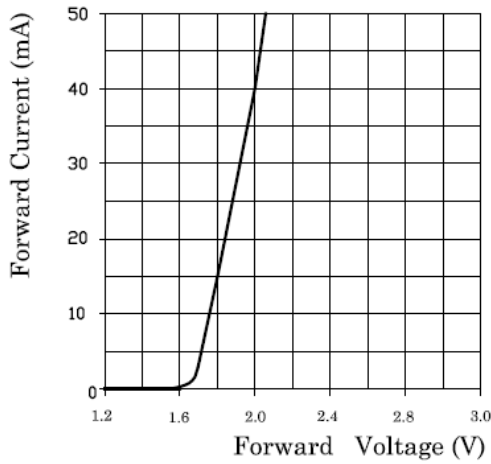

Relative Intensity vs. Forward Current

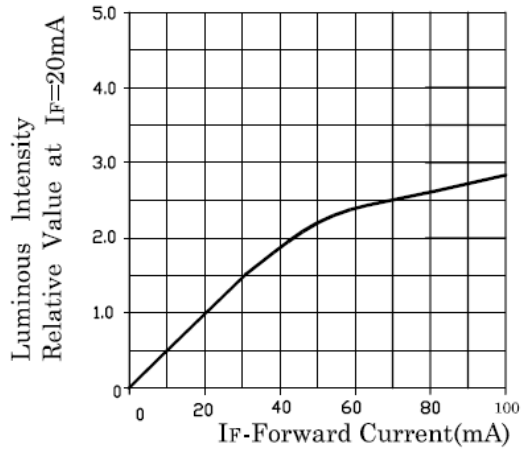

Forward Current vs. Ambient Temperature

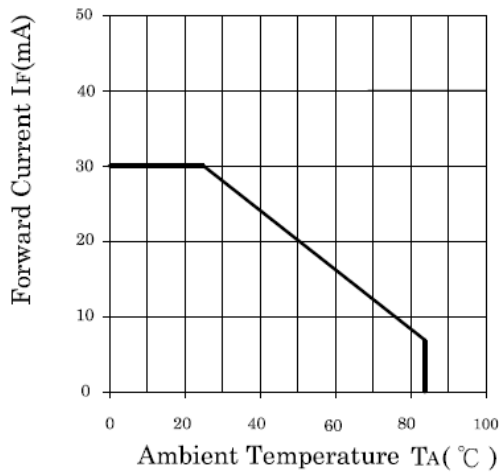

Luminous Intensity vs. Ambient Temperature

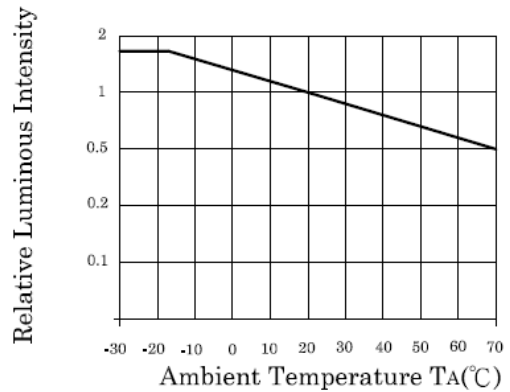

ChromeLED Corp. reserves the right to make changes at any time in order to supply the best product possible. The most current version of this document will always be available at: www.chromeled.com

OPTICAL CHARACTERISTIC CURVES - YELLOW

Forward Current vs. Forward Voltage

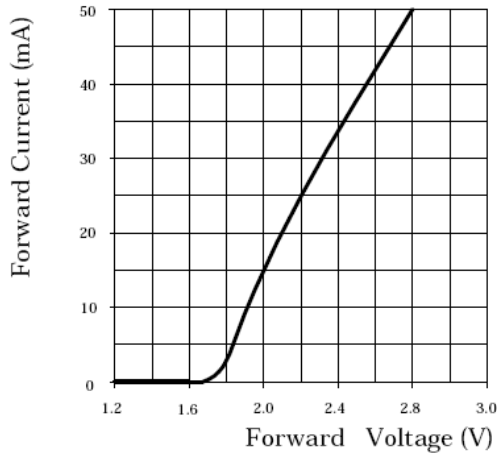

Relative Intensity vs. Forward Current

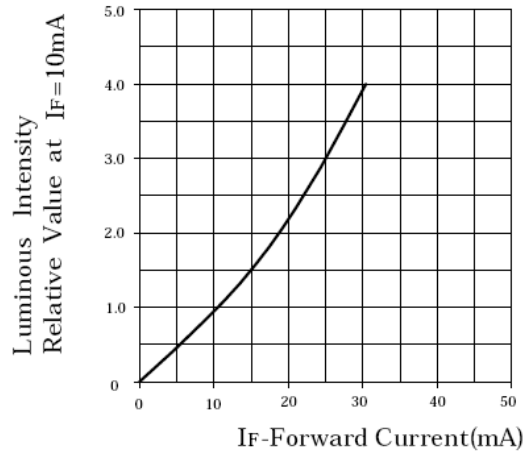

Forward Current vs. Ambient Temperature

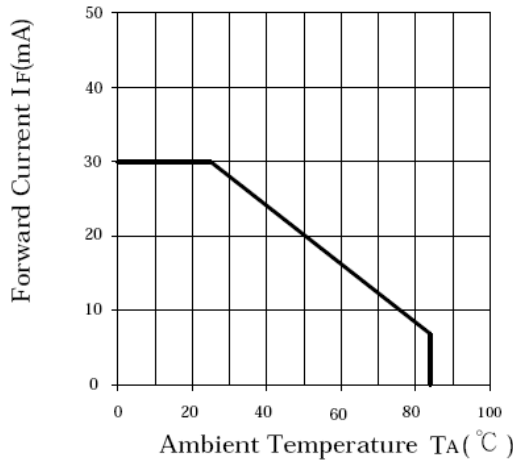

Luminous Intensity vs. Ambient Temperature

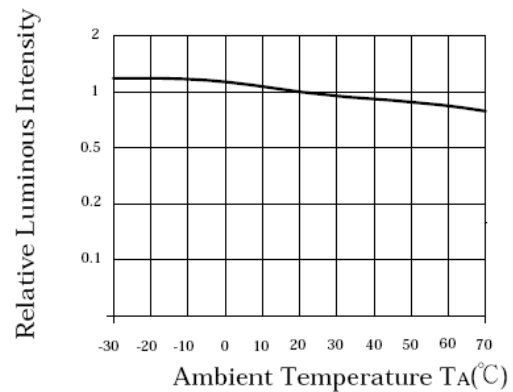

ChromeLED Corp. reserves the right to make changes at any time in order to supply the best product possible. The most current version of this document will always be available at: www.chromeled.com

OPTICAL CHARACTERISTIC CURVES - GREEN

Forward Current vs. Forward Voltage

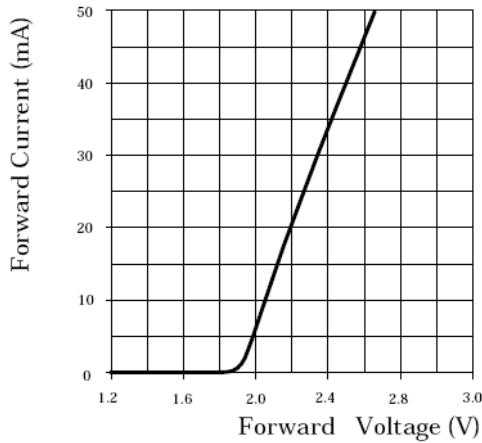

Relative Intensity vs. Forward Current

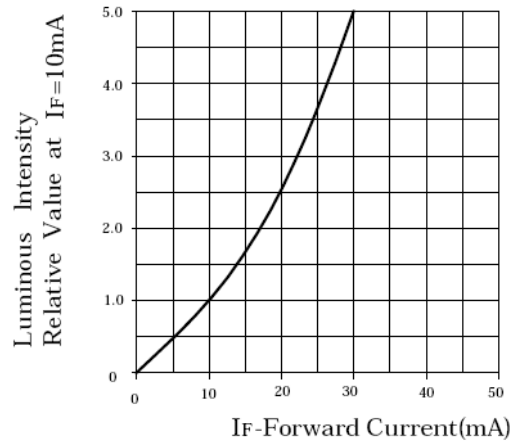

Forward Current vs. Ambient Temperature

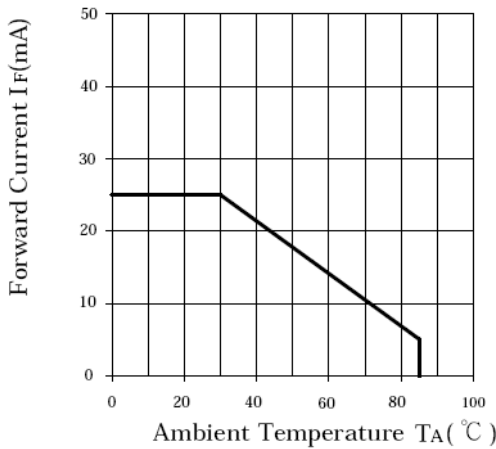

Luminous Intensity vs. Ambient Temperature

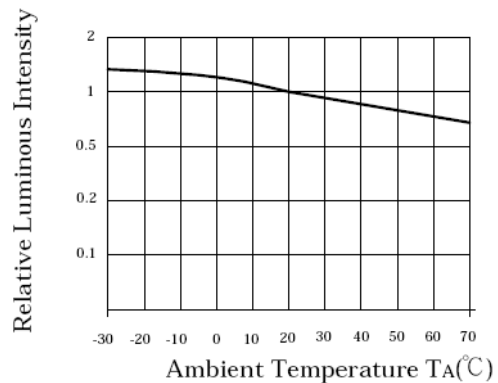

ChromeLED Corp. reserves the right to make changes at any time in order to supply the best product possible. The most current version of this document will always be available at: www.chromeled.com

OPTICAL CHARACTERISTIC CURVES - BLUE

Forward Current vs. Forward Voltage

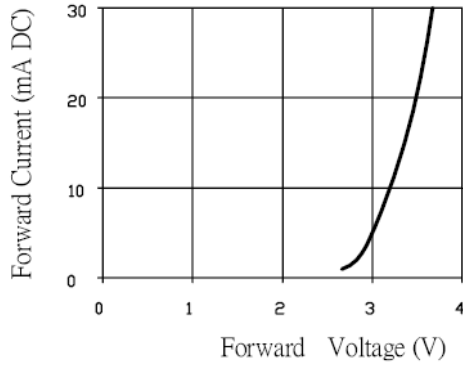

Relative Intensity vs. Forward Current

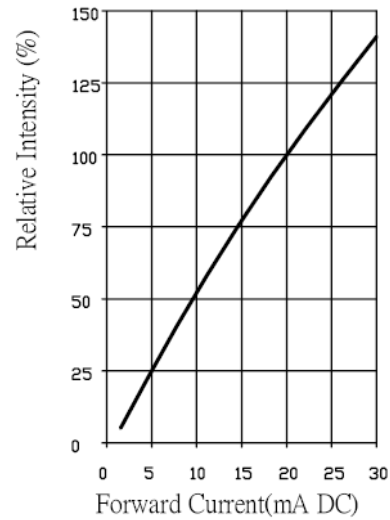

Forward Current vs. Ambient Temperature

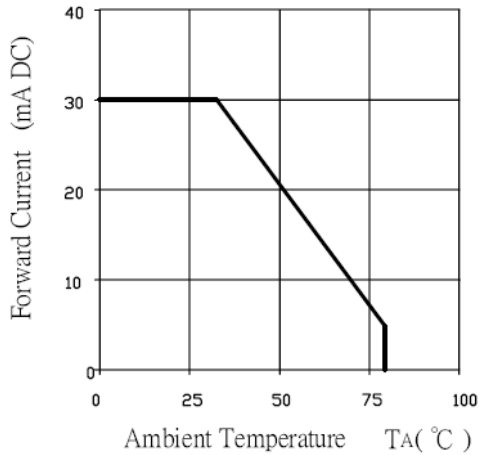

Luminous Intensity vs. Ambient Temperature

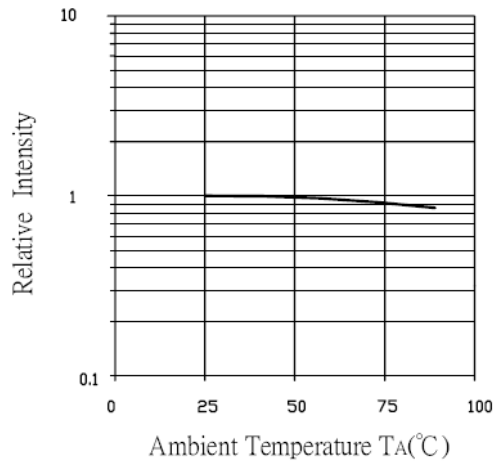

ChromeLED Corp. reserves the right to make changes at any time in order to supply the best product possible. The most current version of this document will always be available at: www.chromeled.com

SOLDERING CONDITIONS - DISPLAY

* Solder the LED no closer than 3mm from the base of the epoxy bulb. Soldering beyond the base of the tie bar is recommended.

* Recommended soldering conditions

Dip Soldering	
Pre-Heat	100 °C Max
Pre-Heat Time	60 Second Max
Solder Bath Temperature	260 °C Max
Dipping Time	5 Second Max
Dipping Position	No lower than 3mm from the base of the epoxy

Hand Soldering		
	3mm Series	Others
Temperature	300 °C Max	350 °C Max
Soldering Time	3 Second Max	3 Second Max
Position	No closer than 3mm from the base of the epoxy	No closer than 3mm from the base of the epoxy

* Do not apply any stress to the lead. Particularly when heated.

* The LED must not be repositioned after soldering.

* After soldering the LEDs, the epoxy bulb should be protected from mechanical shock or vibration until the LEDs return to room temperature.

* Direct soldering onto a PC board should be avoided. Mechanical stress to the resin may be caused by the PC board warping or from the clinching and cutting of the leadframes. When it is absolutely necessary, the LEDs may be mounted in this fashion, but, the user will assume responsibility for any problems. Direct soldering should only be done after testing has confirmed that no damage, such as wire bond failure or resin deterioration, will occur. LEDs should not be soldered directly to double sided PC boards because the heat will deteriorate the epoxy resin.

* When it is necessary to clamp the LEDs to prevent soldering failure, it is important to minimize the mechanical stress on the LEDs.

* Cut the LED leadframes at room temperature. Cutting the leadframes at high temperature may cause LED failure.



ChromeLED Corp. reserves the right to make changes at any time in order to supply the best product possible. The most current version of this document will always be available at: www.chromeled.com