



American Opto Plus LED Corp.

L513LGC

5mm Green LED Lamp

DESCRIPTION

- Round Type
- 5mm Diameter
- Lens Color: Water Clear
- With Flange
- Solder leads without standoffs

FEATURES

- Emitted Color: Green
- High Luminous Intensity
- Technology: AlGaInP
- Viewing Angle: 30°

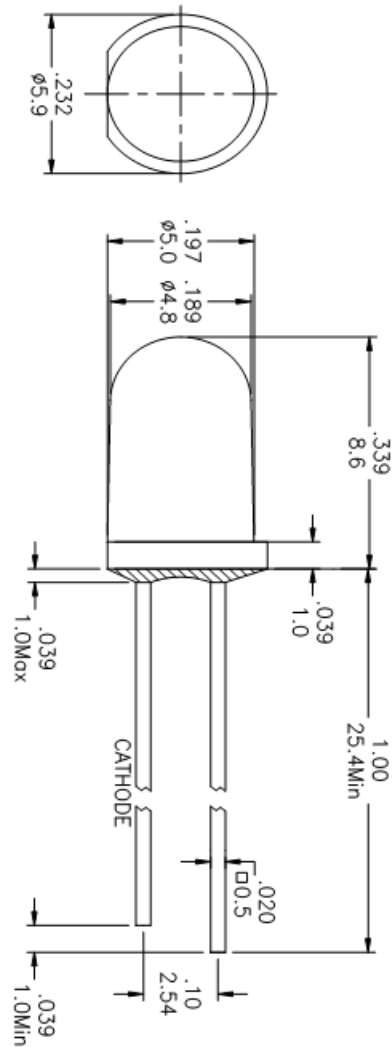

NOTES:

1. All dimensions are in millimeters tolerance is ± 0.25 mm unless otherwise noted;

Part Number	Material	Lens Color	
		Emitted	Lens
L513LGC	AlGaInP	Green	Water Clear



American Opto Plus LED Corp.

L513LGC

5mm Green LED Lamp

ABSOLUTE MAXIMUM RATINGS

(Ta=25°C)

Parameter	Symbol	Ratings	Unit
DC Forward Current	I _F	30	mA
Peak Pulsed Forward Current	I _{FP}	100	mA
Reverse Voltage	V _R	5	V
Power Dissipation	P _d	78	mW
Operating temperature range	Topr	-40~+85	°C
Storage temperature range	Tstg	-40~+100	°C
Lead Soldering Temperature	Tsld	Max. 260°C for 5 sec Max. (3mm from the epoxy body)	

OPTICAL-ELECTRICAL CHARACTERISTICS

(Ta=25°C)

Parameter	Symbol	Test Condition	Min	Typ	Max	Unit
Reverse Current	I _R	V _R =5V	--	--	100	μA
Forward Voltage	V _F	I _F =20mA	--	2.0	2.6	V
Luminous Intensity	I _v		380	640	1080	mcd
Dominant Wavelength	λ _D		--	570	--	nm
Viewing Angle	2θ 1/2		--	30	--	deg

*Note: I_{FP} = Pulse Width ≤ 10ms, Duty Ratio ≤ 1/10



American Opto Plus LED Corp.

L513LGC

5mm Green LED Lamp

LUMINOUS INTENSITY RANK LIMITS ($I_F = 20\text{mA}$)

Unit: mcd

Code	Min	Max
24	380	490
25	490	640
26	640	830
27	830	1080

DOMINANT WAVELENGTH RANK LIMITS ($I_F = 20\text{mA}$)

Unit: nm

Code	Min	Max
YG4	567	569
YG5	569	571
YG6	571	573
YG7	573	575
YG8	575	577

FORWARD VOLTAGE RANK LIMITS ($I_F = 20\text{mA}$)

Unit: V

Code	Min	Max
B	1.6	1.8
C	1.8	2.0
D	2.0	2.2
E	2.2	2.4
F	2.4	2.6



American Opto Plus LED Corp.

L513LGC

5mm Green LED Lamp

TYPICAL ELECTRICAL-OPTICAL CHARACTERISTIC CURVES

Fig 1. Forward Current vs. Forward Voltage

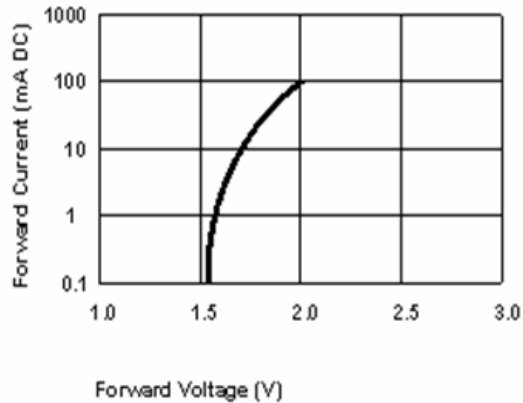

Fig 2. Relative Intensity vs. Forward Current

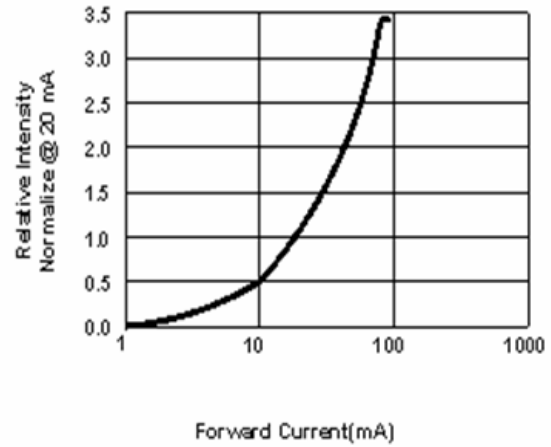

Fig 3. Forward Voltage vs. Temperature

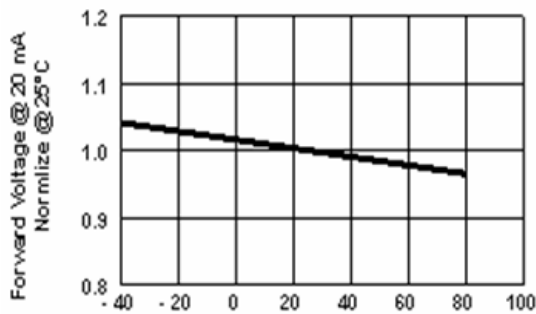

Fig 4. Relative Intensity vs. Temperature

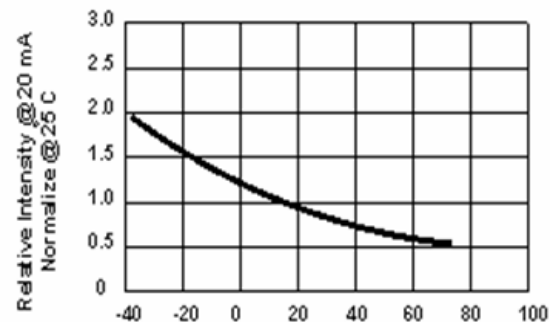

Fig 5. Relative Intensity Vs. Wavelength

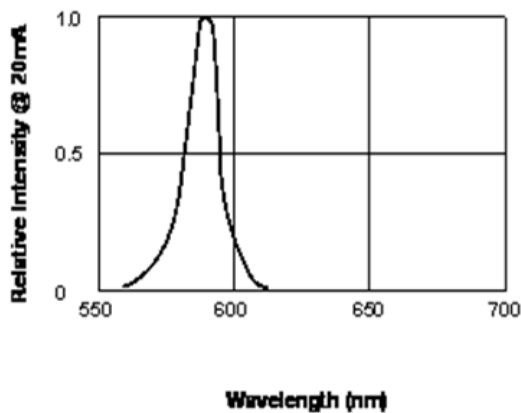
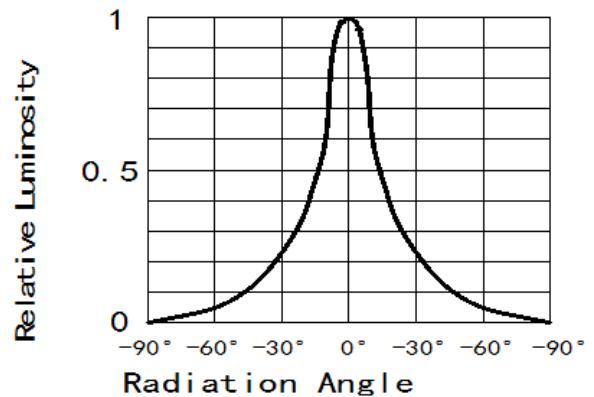

Fig 6. Relative Luminous Intensity vs. Radiation Angle





American Opto Plus LED Corp.

L513LGC

5mm Green LED Lamp

PRECAUTIONS FOR USE

1. Recommended Soldering Conditions

Wave Soldering

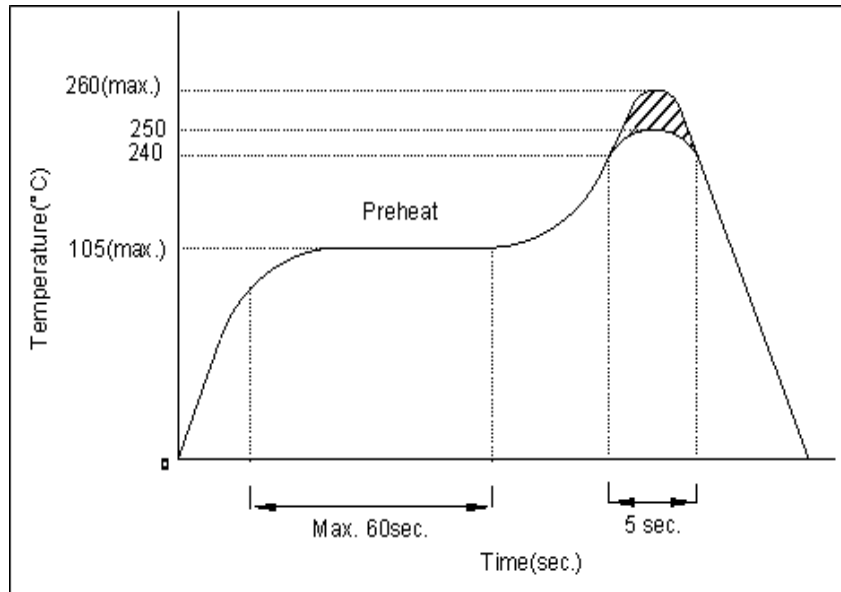

2. Soldering Iron

Basic spec is ≤ 5 sec. when 260°C . If temperature is higher, time should be shorter ($+10^{\circ}\text{C} \rightarrow -1$ sec.). Power dissipation of iron should be smaller than 15W, and temperature should be controllable. Surface temperature of the device should be under 230°C

3. Static Electricity

- Static electricity or surge voltage damages LEDs. It is recommended that a wrist band or an anti-electrostatic glove be used when handling the LEDs.
- All devices, equipment and machinery must be properly grounded. It is recommended that measures be taken against surge voltage to the equipment that mounts the LEDs.