

**VF4A (Standard, Shrouded and Weatherproof)**

- Pin assignment similar to ISO 7588 part 1
- Plug-in terminals
- Customized versions on request
  - Integrated components (e.g. resistor, diode)
  - Customized marking
  - Special covers (e.g. brackets, shrouded)

Typical applications

Cross carline up to 40A for example: ABS control, blower fans, car alarm, cooling fan, Electric Power Steering, energy management, engine control, fuel pump, heated front screen, lamps: front, rear, fog light, main switch/supply relay, valves, wiper control.

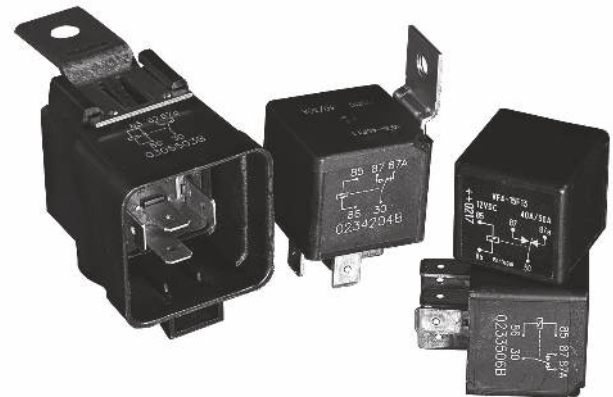

FVF4Aco\_fcw1\_bw

Contact Data	
Contact arrangement	1 form C, 1 CO
Rated voltage	12VDC
Limiting continuous current, form A/form B	NO/NC
23°C	60/45A
85°C	40/30A
125°C	17/12A
Limiting making current <sup>1)</sup> , form A/form B	120/45A
Limiting breaking current, form A/form B	60/40A
Limiting short-time current overload current, ISO 8820-3 <sup>2)</sup>	1.35 x 40A, 1800s 2.00 x 40A, 60s 6.00 x 40A, 1s
Jump start test, ISO 16750-1	24VDC for 5min, conducting nominal current at 23°C
Contact material	silver based
Min. recommended contact load <sup>3)</sup>	1A at 5VDC
Initial voltage drop, form A (NO) contact at 40A, typ./max.	60/200mV
form B (NC) contact at 30A, typ./max.	60/250mV
Frequency of operation at nominal load	6 ops./min (0.1Hz)
Operate/release time typ.	7/2ms <sup>4)</sup>
Electrical endurance, resistive load, form A (NO) contact	>1x10 <sup>5</sup> ops. 40A, 14VDC
resistive load, form B (NC) contact	30A, 14VDC

Contact Data (continued)	
Mechanical endurance	>1x10 <sup>6</sup> ops.

- 1) The values apply to a resistive or inductive load with suitable spark suppression and at maximum 14VDC for 12VDC or 28VDC for 24VDC load voltages. For a load current duration of maximum 3s for a make/break ratio of 1:10.
- 2) Current and time are compatible with circuit protection by a typical automotive fuse. Relay will make, carry and break the specified current.
- 3) See chapter Diagnostics of Relays in our Application Notes or consult the internet at <http://relays.te.com/appnotes/>
- 4) For unsuppressed relay coil. A low resistive suppression device in parallel to the relay coil increases the release time and reduces the lifetime caused by increased erosion and/or higher risk of contact tack welding.

Coil Data					
Rated coil voltage	12/24VDC				
Coil versions, DC coil					
Coil code	Rated voltage VDC	Operate voltage VDC	Release voltage VDC	Coil resistance <sup>5)</sup> Ω±10%	Rated coil power <sup>5)</sup> W
F	12	7.2	1.2	90	1.6
H	24	14.4	2.4	360	1.6

5) Without components in parallel.  
All figures are given for coil without pre-energization, at ambient temperature +23°C.

**Max. DC load breaking capacity**

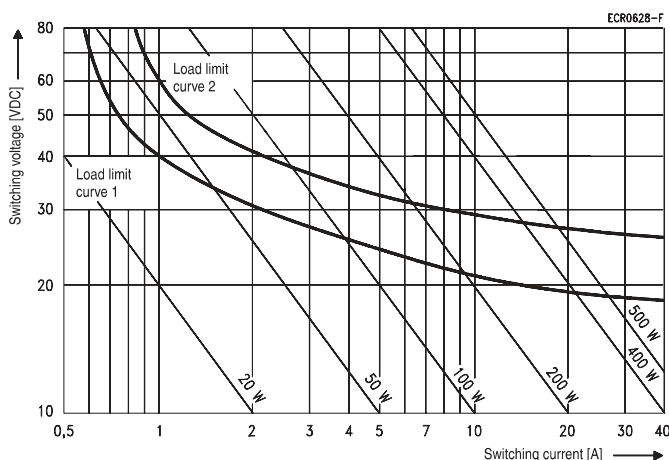

Load limit curve 1: arc extinguishes during transit time (changeover contact).  
Load limit curve 2: safe shutdown, no stationary arc (make contact).  
Load limit curves measured with low inductive resistors verified for 1000 switching events.

**Coil operating range**

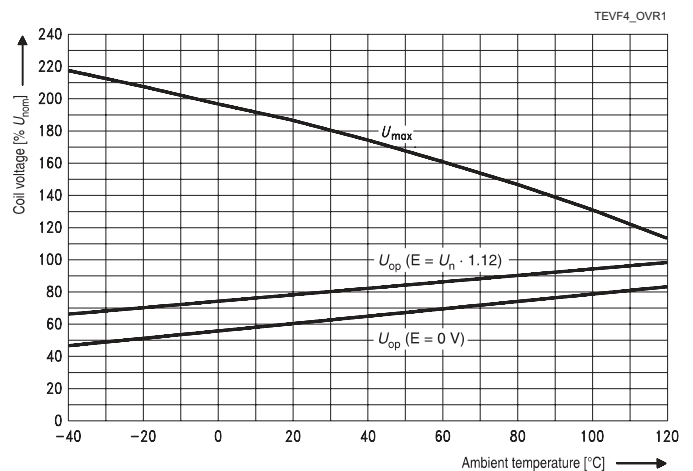

Does not take into account the temperature rise due to the contact current  
E = pre-energization.

**VF4A (Standard, Shrouded and Weatherproof) (Continued)**

**Insulation Data**

Initial dielectric strength	
between open contacts	500V <sub>rms</sub>
between contact and coil	500V <sub>rms</sub>
between adjacent contacts	500V <sub>rms</sub>

**Other Data**

EU RoHS/ELV compliance	compliant
Protection to heat and fire according UL94	UL94-HB or better
Ambient temperature	-40 to 125°C
Category of environmental protection, IEC 61810	RT I (dustproof), RT III (sealed/sealed – shrouded)
Degree of protection, IEC 60529	IP54 (dustproof), IP67 (sealed) IP67 (sealed – shrouded), only with special connector
Vibration resistance (functional) IEC 60068-2-6 (sine sweep)	10 to 500Hz, min. 5g <sup>6)</sup>
Shock resistance (functional) IEC 60068-2-27 (half sine)	11ms, min. 20g <sup>6)</sup>
Drop test, free fall, IEC 60068-2-32	1m onto concrete

**Other Data (continued)**

Terminal type	plug-in, QC
Cover retention	
axial force	150N
pull force	200N
push force	200N
Terminal retention	
pull force	100N
push force	100N
resistance to bending	10N <sup>7)</sup>
force applied to side	10N <sup>7)</sup>
torque	0.3Nm
Weight	approx. 35 to 60g (1.2 to 2.1oz)
Packaging unit	
cover type VF4-1	357 pcs.
VF4-4	200 pcs.
VF4-5, VF4-6	110 pcs.

6) No change in the switching state > 1ms. Valid for NC contacts, NO contact values significantly higher.

7) Values apply 2mm from the end of the terminal. When the force is removed, the terminal must not have moved by more than 0.3mm.

**Accessories**

For details see datasheet Connectors for Mini,  
Mini (Shrouded) and Maxi ISO Relays

**Terminal Assignment**

CO  
1 form C, 1 CO

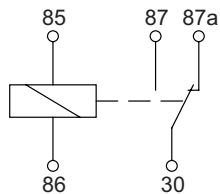

COD  
1 form C, 1 CO with diode

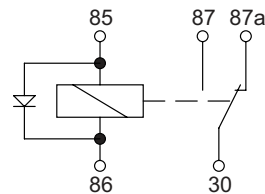

COR  
1 form C, 1 CO with resistor

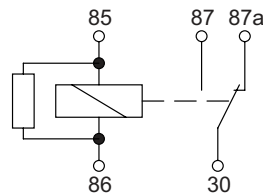

**Dimensions**

VF4A with dust cover  
VF4-1\*\*\*\* (without bracket) and VF4-4\*\*\*\* (with bracket)

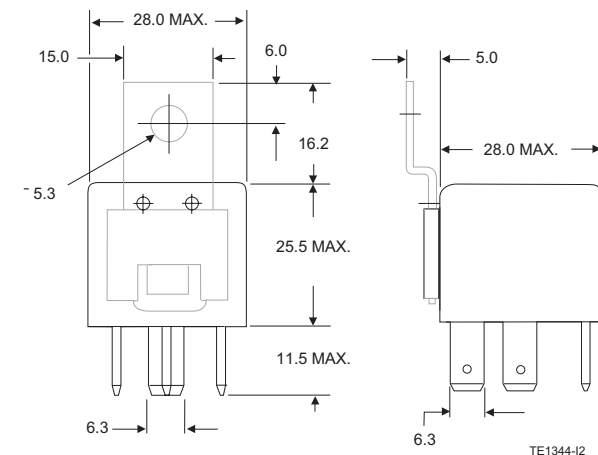

View of the terminals (bottom view)

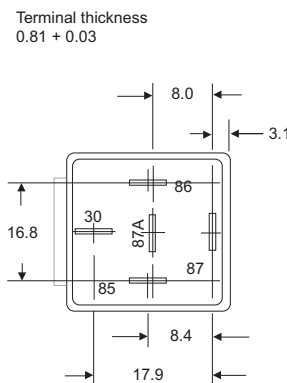

**VF4A (Standard, Shrouded and Weatherproof)** (Continued)

**Dimensions**

VF4A with shrouded dust cover  
VF4-2\*\*\*\* (without bracket) and VF4-5\*\*\*\* (with bracket)

View of the terminals (bottom view)

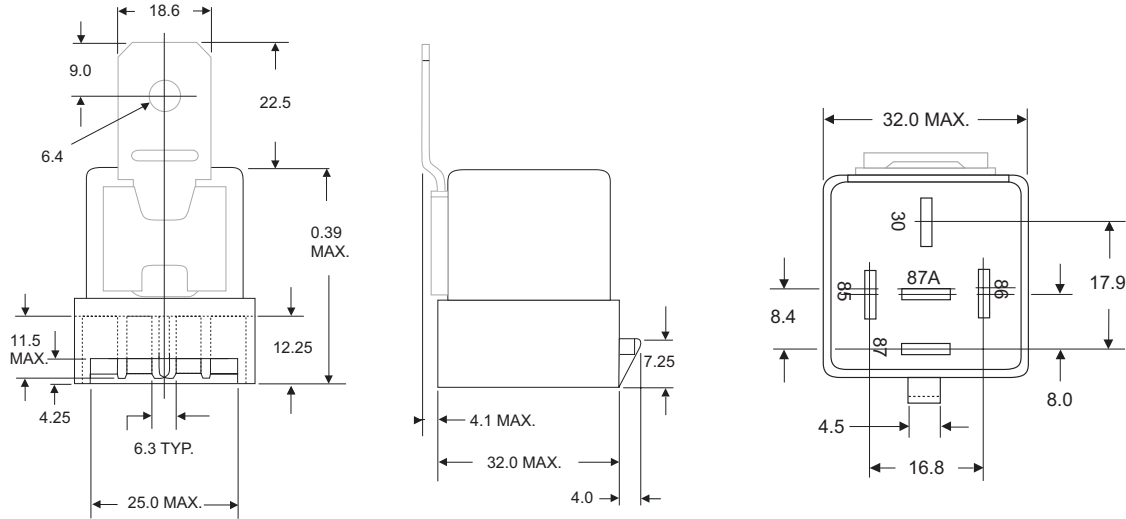

TE1347-82

VF4A with weatherproof cover  
VF4-3\*\*\*\* (without bracket) and VF4-6\*\*\*\* (with bracket)

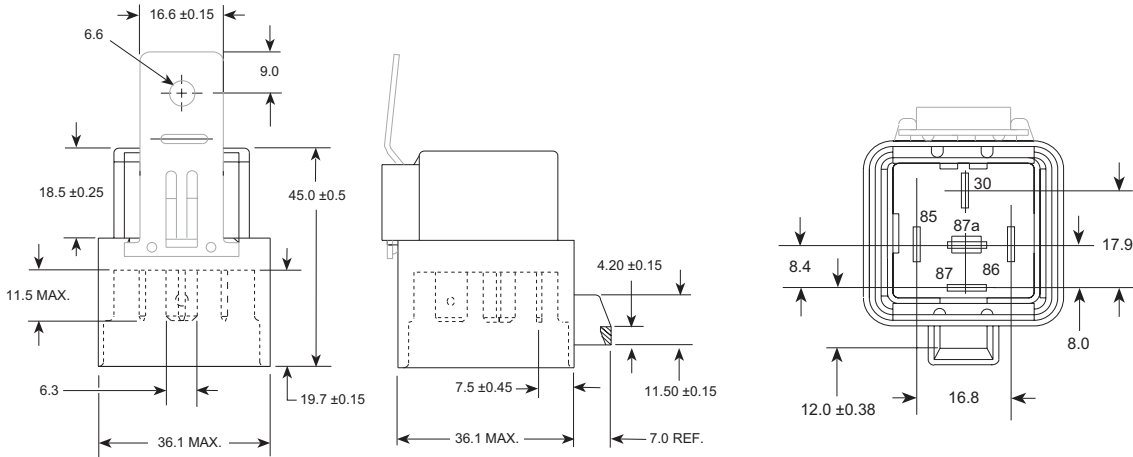

TE1348-91

**VF4A (Standard, Shrouded and Weatherproof)** (Continued)

<b>Product code structure</b>		Typical product code		<b>VF4</b>	<b>-1</b>	<b>5</b>	<b>F</b>	<b>11</b>	<b>-S01</b>
<b>Type</b>		VF4A							
<b>Cover type</b>		1 Dust cover standard		2 Shrouded dust cover standard					
3 Weatherproof cover standard		4 Dust cover with bracket							
5 Shrouded dust cover with bracket		6 Weatherproof cover with bracket							
<b>Contact arrangement</b>		5 1 form C, 1 CO							
<b>Coil</b>		F 12VDC		H 24VDC					
<b>Contact material</b>		11 Silver based		21 Silver based for capacitive loads					
<b>Coil suppression</b>		S01 Resistor in parallel (680Ω)		S05 Diode in parallel (cathode 86)					
S08 Resistor in parallel (2700Ω)									

Product code	Arrangement	Cover	Coil suppr.	Circuit <sup>1)</sup>	Coil	Cont. material	Terminals	Part number
VF4A-15F11	1 form C,	Standard		CO	12VDC	Silver based	Plug-in, QC	6-1393298-0
VF4A-15F11-S01	1 CO		Resistor 680Ω	COR				6-1393298-4
VF4A-15F11-S05			Diode (cathode 86)	COD				6-1393298-5
VF4A-15F21-S01			Resistor 680Ω	COR		Silver based <sup>2)</sup>		7-1393298-3
VF4A-15H11				CO	24VDC	Silver based		8-1393298-1
VF4A-15H11-S08			Resistor 2700Ω	COR				5-1393305-7
VF4A-45F11		Bracket		CO	12VDC			8-1393298-8
VF4A-45F11-S01			Resistor 680Ω	COR				1-1393302-0
VF4A-45H11				CO	24VDC			1-1393302-1
VF4A-55F11-S01		Shrouded	Resistor 680Ω	COR	12VDC			8-1393305-7
VF4A-65F11-S01								9-1393305-5
VF4A-65H11-S08		Weatherproof						
			Resistor 2700Ω			24VDC		

1) See terminal assignment diagrams.

2) Special contact material for capacitive loads.

Other types on request.

This list represents the most common types and does not show all variants covered by this datasheet.