



Features

- Bidirectional TVS
- Low capacitance - 12 pF
- ESD protection >15 kV
- Fits 0402 footprint



This series is currently available but not recommended for new designs.

CDDFN2-TxxC Series - Surface Mount TVS Diode

General Information

The CDDFN2-TxxC Series provides ESD and EFT protection for external ports of electronic devices such as cellular phones, hand held electronics and other portable electronic devices.

The device measures 1.05 mm x 0.65 mm and is available in a DFN-2 package and is intended to be mounted directly onto an FR4 printed circuit board. The device will fit an 0402 footprint.

The device is designed to meet IEC 61000-4-2(ESD) and IEC 61000-4-4(EFT) protection requirements.



Absolute Maximum Ratings (@ T_A = 25 °C Unless Otherwise Noted)

Parameter	Symbol	CDDFN2-			Unit
		5.0C	12C	24C	
Peak Pulse Power @ 8/20 μs	P _{pk}	75	25	47	W
Peak Pulse Current @ 8/20 μs	I _{pp}	5	1	1	A
Operating Temperature	T _{OPR}	-40 to +125			°C
Storage Temperature	T _{STG}	-55 to +150			°C

Electrical Characteristics (@ T_A = 25 °C Unless Otherwise Noted)

Parameter	Symbol	CDDFN2-			Unit
		5.0C	12C	24C	
Maximum Working Peak Voltage	V _{wm}	5.0	12	24	V
Minimum Breakdown Voltage @ 1 mA	V _{BR}	6.0	13	25	V
Maximum Leakage Current @ V _{wm}	I _L	2.0			μA
Typical Capacitance @ 0 V 1 MHz	C _J	15	12	10	pF
Maximum Capacitance @ 0 V 1 MHz	C _J	20			pF
Maximum Clamping Voltage @ I _{pp} 8/20 μs	V _C	15	25	47	V
ESD Protection per IEC 61000-4-2					
Minimum Contact Discharge	ESD	8			kV
Minimum Air Discharge	ESD	15			kV

*RoHS Directive 2002/95/EC Jan. 27, 2003 including annex and RoHS Recast 2011/65/EU June 8, 2011.

Specifications are subject to change without notice.

The device characteristics and parameters in this data sheet can and do vary in different applications and actual device performance may vary over time. Users should verify actual device performance in their specific applications.

CDDFN2-TxxC Series - Surface Mount TVS Diode



Product Dimensions

This is a Molded DFN-2 package with lead free 100 % Au plating on the terminations. It weighs approximately 10 mg.

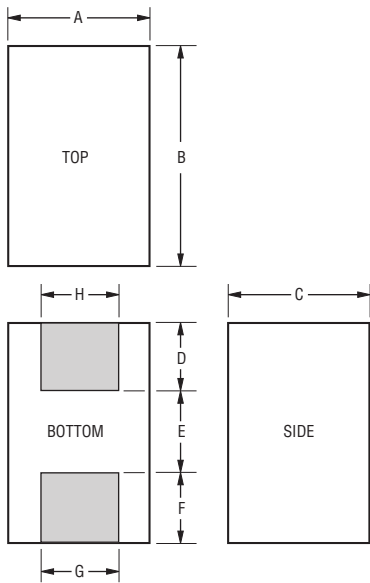

Dimensions	
A	$\frac{0.55-0.65}{(0.022-0.026)}$
B	$\frac{0.95-1.05}{(0.037-.041)}$
C	$\frac{0.45-0.55}{(0.018-.022)}$
D	$\frac{0.30}{(0.012)}$ TYP.
E	$\frac{0.43}{(0.017)}$ TYP.
F	$\frac{0.30}{(0.012)}$ TYP.
G	$\frac{0.50}{(0.020)}$ TYP.
H	$\frac{0.50}{(0.020)}$ TYP.

DIMENSIONS: $\frac{\text{MM}}{\text{(INCHES)}}$

Recommended PCB Footprint

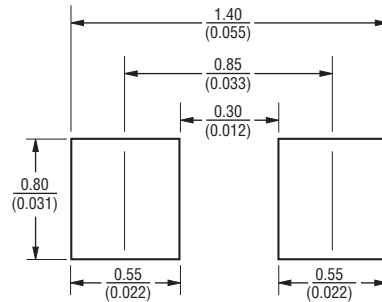

Typical Part Marking

CDDFN2-T5.0C	E5
CDDFN2-T12C	E2
CDDFN2-T24C	E4

How to Order

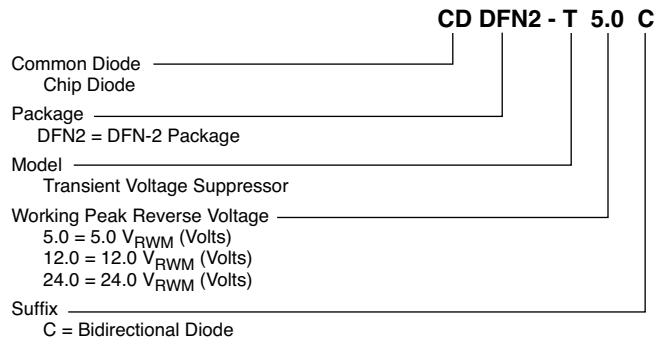

Block Diagram

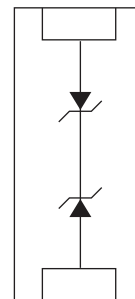

Specifications are subject to change without notice.

The device characteristics and parameters in this data sheet can and do vary in different applications and actual device performance may vary over time. Users should verify actual device performance in their specific applications.

CDDFN2-TxxC Series - Surface Mount TVS Diode



Rating & Characteristic Curves

Pulse Waveform

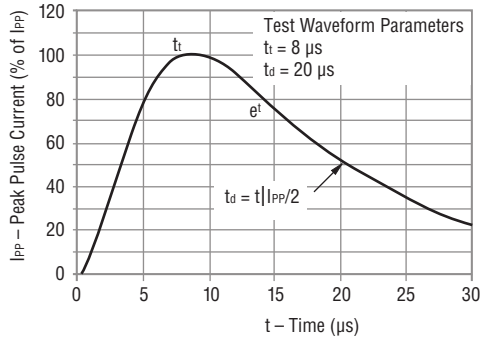

Reverse Characteristics

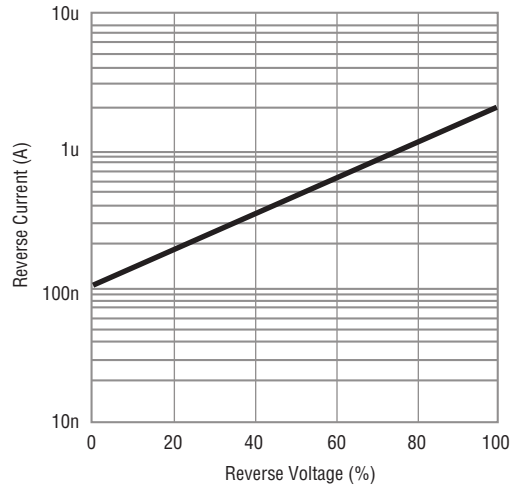

Power Derating Curve

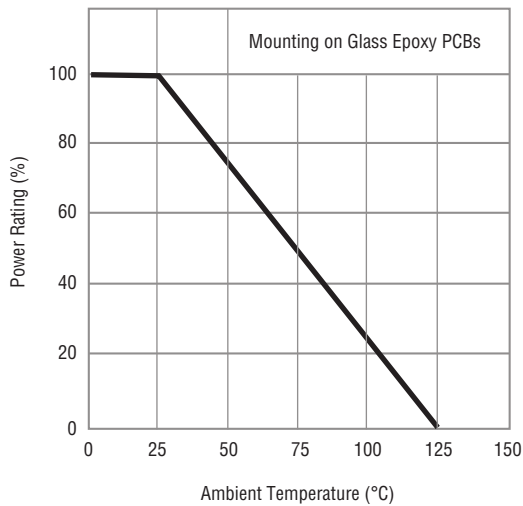

Capacitance Between Terminals

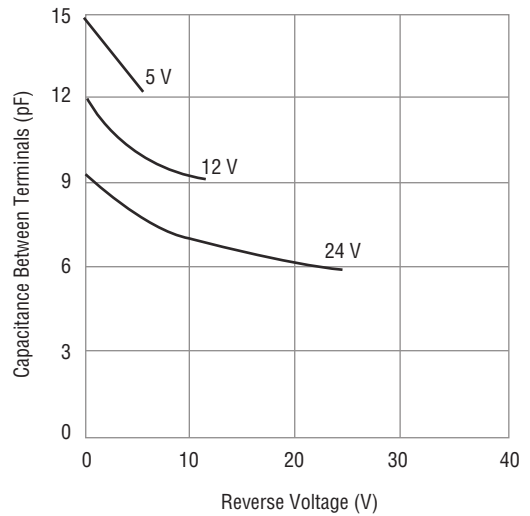

Specifications are subject to change without notice.
 The device characteristics and parameters in this data sheet can and do vary in different applications and actual device performance may vary over time.
 Users should verify actual device performance in their specific applications.

CDDFN2-TxxC Series - Surface Mount TVS Diode

BOURNS®

Packaging Information

The surface mount product is packaged in an 8 mm x 4 mm tape and reel format per EIA-481 standard.

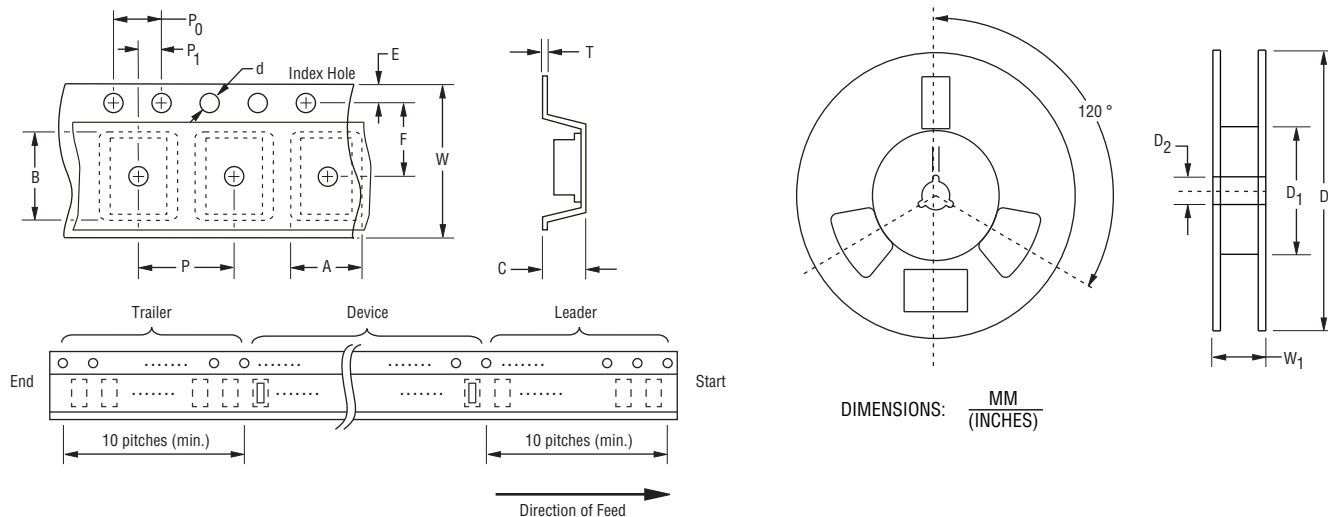

Item	Symbol	DFN-2
Carrier Width	A	$\frac{0.80 \pm 0.10}{(0.031 \pm 0.004)}$
Carrier Length	B	$\frac{1.20 \pm 0.10}{(0.047 \pm 0.004)}$
Carrier Depth	C	$\frac{0.70 \pm 0.10}{(0.027 \pm 0.004)}$
Sprocket Hole	d	$\frac{1.55 \pm 0.05}{(0.061 \pm 0.002)}$
Reel Outside Diameter	D	$\frac{178}{(7.008)}$
Reel Inner Diameter	D ₁	$\frac{50.0}{(1.969)}$ MIN.
Feed Hole Diameter	D ₂	$\frac{13.0 \pm 0.20}{(0.512 \pm 0.008)}$
Sprocket Hole Position	E	$\frac{1.75 \pm 0.10}{(0.069 \pm 0.004)}$
Punch Hole Position	F	$\frac{3.50 \pm 0.05}{(0.138 \pm 0.002)}$
Punch Hole Pitch	P	$\frac{4.00 \pm 0.10}{(0.157 \pm 0.004)}$
Sprocket Hole Pitch	P ₀	$\frac{4.00 \pm 0.10}{(0.157 \pm 0.004)}$
Embossment Center	P ₁	$\frac{2.00 \pm 0.05}{(0.079 \pm 0.002)}$
Overall Tape Thickness	T	$\frac{0.20 \pm 0.10}{(0.008 \pm 0.004)}$
Tape Width	W	$\frac{8.00 \pm 0.20}{(0.315 \pm 0.008)}$
Reel Width	W ₁	$\frac{14.4}{(0.567)}$ MAX.
Quantity per Reel	--	5000

REV. 12/15

Specifications are subject to change without notice. The device characteristics and parameters in this data sheet can and do vary in different applications and actual device performance may vary over time. Users should verify actual device performance in their specific applications.