

1

2

3

4

5

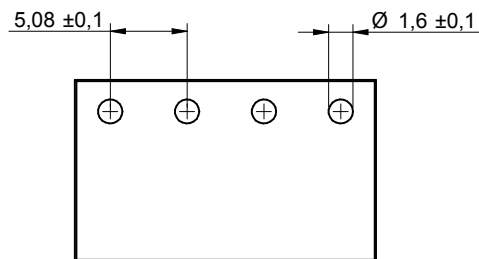

RECOMMENDED PCB LAYOUT - COMPONENT VIEW

## CHARACTERISTICS

## MATERIAL

Insulator material : LCP  
 Flammability rating : UL94-V0  
 Colour : Black  
 Contact pin : Brass (CuZn)  
 Surface of solder tail plating : Tin Plated

## ENVIRONMENTAL

Operating temperature : -40°C up to 105°C  
 Compliance : Lead free and RoHS

## SOLDERING

Solder temperature : Reflow process as per JEDEC J-020D-STD

## ELECTRICAL

Current rating : 10A  
 Working voltage : 300 Vac  
 Dielectric withstanding voltage : 4 kVac/min  
 Contact resistance : 20 mΩ max

## STANDARD

 Certified : E315414 / Model number 7015

## MECHANICAL

Pitch : 5.08mm

## PACKAGING

Tape & Reel

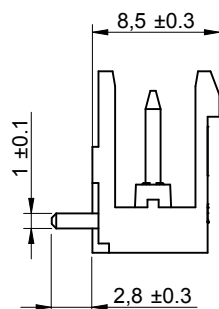
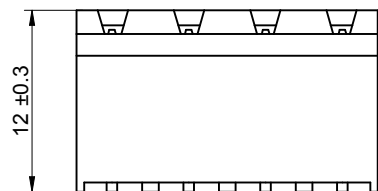
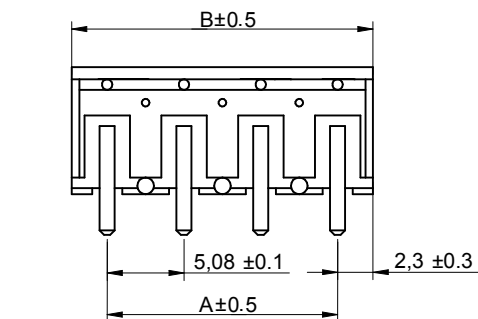

Poles	A	B
2	5.08	9.76
3	10.16	14.84
4	15.24	19.92
5	20.32	25
6	25.4	30.08
7	30.48	35.16
8	35.56	40.24
9	40.64	45.32
10	45.72	50.4
11	50.8	55.48
12	55.88	60.56

RoHS Compliant

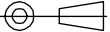
G	F	E	D	C	B	A	REV
			14-OCT-13	29-JUL-13	19-DEC-11	14-SEP-11	DATE
			PIN DIMENSION	DWG REVIEW	6917015300xx	PDF	FILE
			QL	QL	QL	QL	BY
PROJECTION:			APPROVAL: RJ		UNIT: MM		DESCRIPTION: SERIE 7015B - 5.08MM OPEN HORIZONTAL PCB HEADER - THR TYPE WERI PART NO: 691 701 530 0xx B
					SCALE: 2/1		
					SHEET: 1/2		
					DRAW: QUENTIN		
GENERAL TOLERANCE							SIZE
.X = +/_ 0.2							A4
.XX = +/_ 0.15							



A

B

C

D

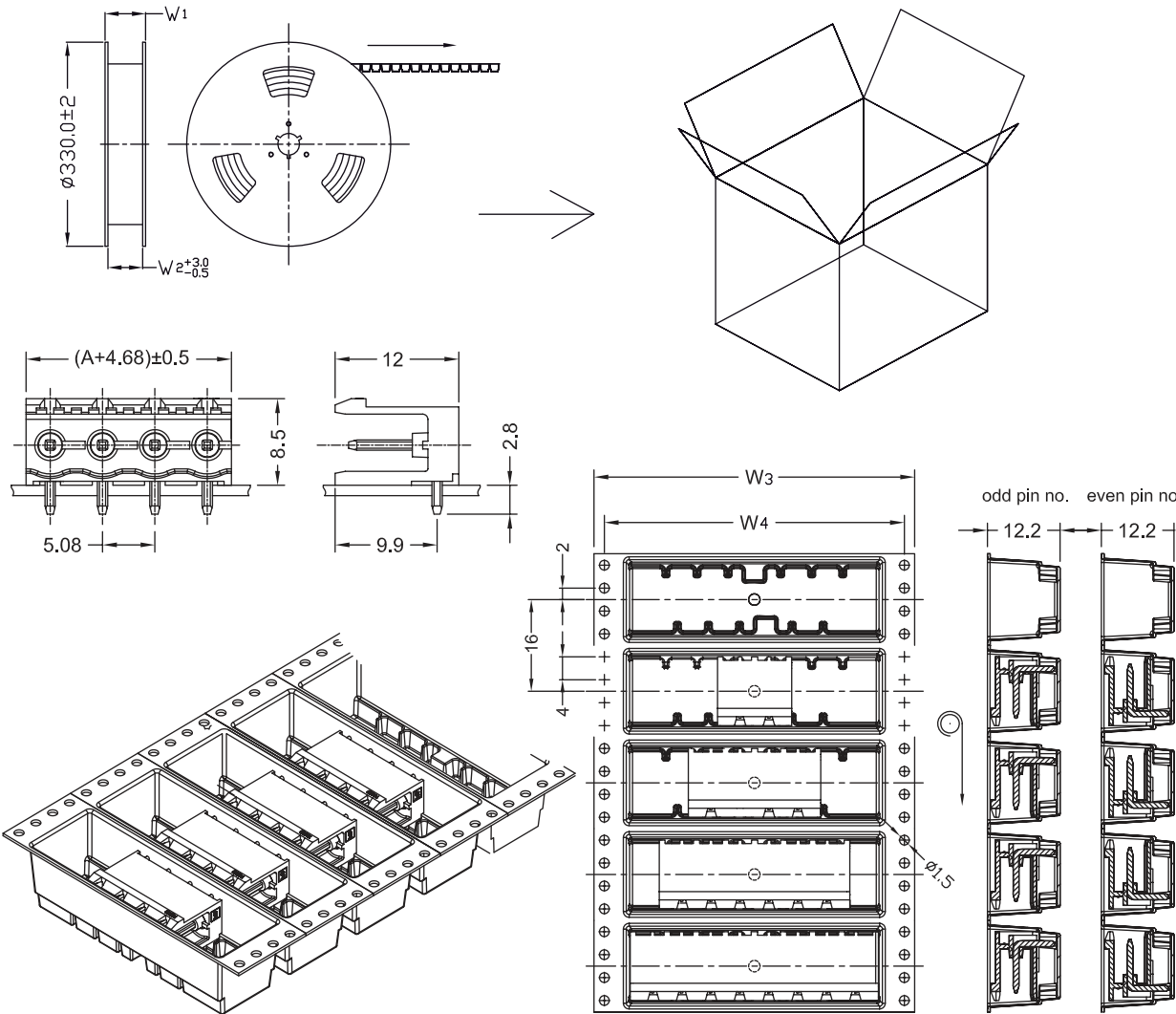

1. 10 sprocket hole pitch cumulative tolerance  $\pm 0.20$
2. Carrier camber is within 1 mm in 250 mm.
3. Material : Black Conductive Polystyrene Alloy.  
Transparent anti-static PET
4. All dimensions meet EIA-481-C requirements.
5. Thickness :  $0.50 \pm 0.05$  mm.
6. Component load per 13" reel : 250 pcs.

Poles	A	Dimension				Packing (Reel/cotton)	Carton dimensions (cm)	Quantity / Carton
		W1(mm)	W2(mm)	W3(mm)	W4(mm)			
2	5.08	36.4	32	32	28.4	10	33.5 x 33.5 x 40	2500
3	10.16	36.4	32	32	28.4	10	33.5 x 33.5 x 40	2500
4	15.24	36.4	32	32	28.4	10	33.5 x 33.5 x 40	2500
5	20.32	60.4	56	56	52.5	6	33.5 x 33.5 x 40	1500
6	25.40	60.4	56	56	52.5	6	33.5 x 33.5 x 40	1500
7	30.48	60.4	56	56	52.5	6	33.5 x 33.5 x 40	1500
8	35.56	60.4	56	56	52.5	6	33.5 x 33.5 x 40	1500
9	40.64	92.4	88	88	84.4	4	33.5 x 33.5 x 40	1000
10	45.72	92.4	88	88	84.4	4	33.5 x 33.5 x 40	1000
11	50.80	92.4	88	88	84.4	4	33.5 x 33.5 x 40	1000
12	55.88	92.4	88	88	84.4	4	33.5 x 33.5 x 40	1000

RoHS Compliant			
G			
F			
E			
D			
C			
B			
A			
REV	DATE	FILE	BY

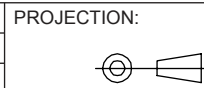

GENERAL TOLERANCE  
 .X =  $\pm 0.2$   
 .XX =  $\pm 0.15$



APPROVAL: RJ

UNIT: MM  
 SCALE:  
 SHEET: 2/2  
 DRAW: QUENTIN

DESCRIPTION: SERIE 7015B - 5.08MM OPEN HORIZONTAL PCB HEADER - THR TYPE

WERI PART NO: 691 701 530 0xx B

SIZE  
**A4**