

**8 POLE
M12 FEMALE**

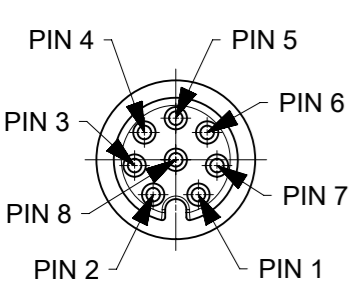

PIN	WIRE COLOR	PIN	WIRE COLOR
1	WH	5	GY
2	BN	6	PK
3	GN	7	BU
4	YE	8	RD

**12 POLE
M12 FEMALE**

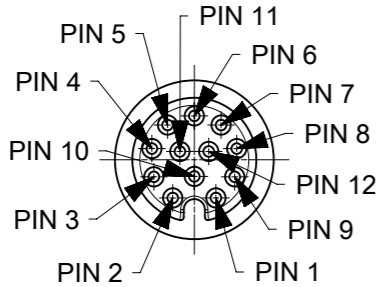

PIN	WIRE COLOR	PIN	WIRE COLOR
1	WH	7	BU
2	BN	8	RD
3	GN	9	BK
4	YE	10	VT
5	GY	11	GY/PK
6	PK	12	RD/BU

PART No MATRIX

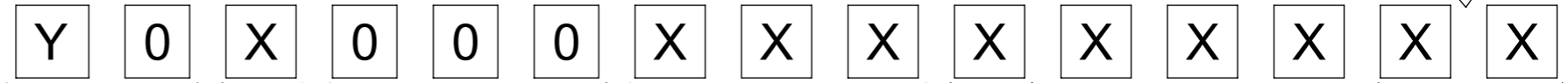

Y0= ULTRA LOCK 2.0
SINGLE ENDED

POLES:
8 = 8 POLES
C = 12 POLES

HEADER:
000= FEMALE STR

CABLE:
E02 - 8x0.25 PVC BLACK
B41 - 8x0.25 WSOR BLACK
H08 - 8x0.25 PUR-LS0H BLACK
H45 - 12x0.14 PUR BLACK

UNIT:
M = METER
F = FEET
C = CENTIMETER
T = 10M

LENGTH:
EXAMPLE:
010 = 1 m
050 = 5 m
100 = 10 m

OVERMOLD:
BLANK = STANDARD BRAD:
-YELLOW IN THE USA
-BLACK IN EUROPE
A = GREY
E = RED
G = BLACK
Y = YELLOW
H = STD. COLOUR WITH TWO
I/D-TAG CARRIERS

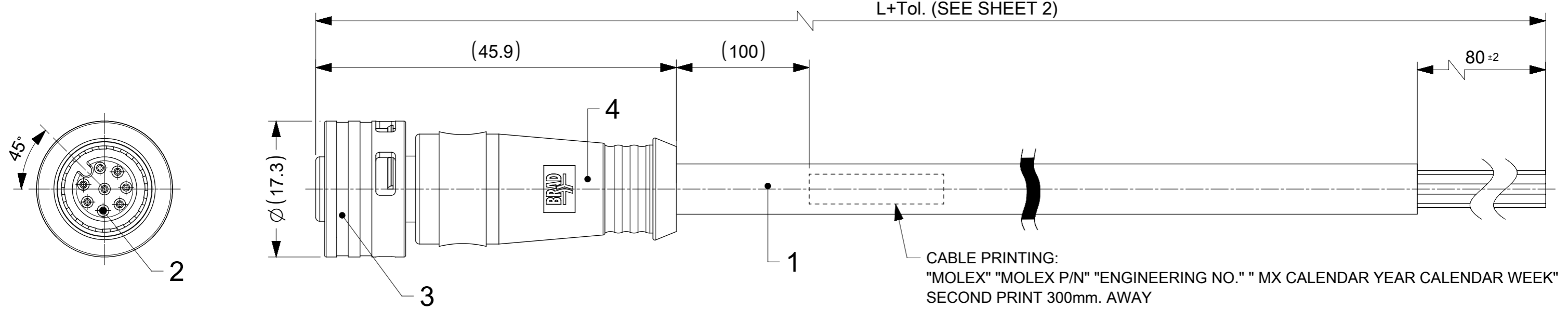

- NOTES:
- PARTS ACC. TO PRODUCT SPECIFICATION 1204000001 PS P10 AND IN STYLE OF IEC-61076-2-010
 - BOM & PART LIST - SEE SHEET 2
 - RATED VOLTAGE :
8, 12 CONTACTS: 30V AC OR DC
RATED CURRENT:
8 CONTACTS: 2A
12 CONTACTS: 1.5A,
DERATING HAS TO BE CONSIDERED
OVERVOLTAGE CATEGORY: 3
POLLUTION DEGREE: 3, ONLY IN MATED AND LOCKED CONDITION
 - PROTECTION CLASS: IP 67, ONLY IN MATED AND LOCKED CONDITION
 - TEMPERATURE RANGE:
TEMPERATURE PLUG/SOCKET: -40 °C TO +85 °C
TEMPERATURE CABLE: SEE CABLE LIST
 - MECHANICAL OPERATIONS: 100 CYCLES
 - MATES WITH ULTRA-LOCK M12 MALE RECEPTACLES
 - PACKAGING: THE CORDSETS ARE SINGLE PACKED IN PLASTIC BAGS AND DELIVERED IN CARTON BOXES
 - UL CSA FILE REGISTRATION PENDING

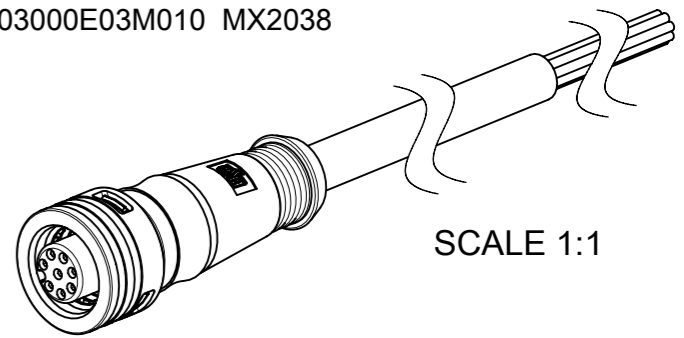

FUNCTIONAL SYMBOLS ▽/A = 0 ▽/E = 0 ▽/V = 0	THIS DRAWING CONTAINS INFORMATION THAT IS PROPRIETARY TO MOLEX ELECTRONIC TECHNOLOGIES, LLC AND SHOULD NOT BE USED WITHOUT WRITTEN PERMISSION	CURRENT REV DESC: NOTES AND CABLE LIST UPDATED			
	DIMENSION UNITS: mm	SCALE: 2:1	CSE U12 8-12P AC FE STR XM SE UNSH BK		
	GENERAL TOLERANCES (UNLESS SPECIFIED)	EC NO: 736602		PRODUCT CUSTOMER DRAWING	
	ANGULAR TOL ± 1.0 °	DRWN: RSCHIEBER 2023/01/31		DOCUMENT NUMBER: 1204000100	
4 PLACES ±	CHK'D: RSILLER 2023/01/31		DOC TYPE: PSD		
3 PLACES ±	APPR: RSILLER 2023/01/31		DOC PART: 000		
2 PLACES ± 0.05	INITIAL REVISION:		REVISION: B3		
1 PLACE ± 0.3	DRWN: RSCHIEBER 2020/09/15		SERIES: A3-SIZE		
0 PLACES ± 0.5	APPR: RSILLER 2020/09/29		MATERIAL NUMBER: 120400		
DRAFT WHERE APPLICABLE MUST REMAIN WITHIN DIMENSIONS	THIRD ANGLE PROJECTION	DRAWING: A3-SIZE	SERIES: 120400	CUSTOMER: GENERAL MARKET	SHEET NUMBER: 1 OF 2

MOLEX NO.	ENGINEERING NO.	LENGHT (MM)
1204000100	Y08000E02M010	1000
1204000101	Y08000E02M020	2000
1204000102	Y08000E02M050	5000
1204000103	Y08000E02M100	10000
1204000104	Y08000B41M010	1000
1204000105	Y08000B41M020	2000
1204000106	Y08000B41M050	5000
1204000107	Y08000B41M100	10000
1204000108	Y08000H08M010	1000
1204000109	Y08000H08M020	2000
1204000110	Y08000H08M050	5000
1204000111	Y08000H08M100	10000
1204000112	Y0C000H45M010	1000
1204000113	Y0C000H45M020	2000
1204000114	Y0C000H45M050	5000
1204000115	Y0C000H45M100	10000

MOLEX NO.	ENGINEERING NO.	LENGHT (MM)

MOLEX NO.	ENGINEERING NO.	LENGHT (MM)

C CABLE LIST

8P	12P	CABLE TYPE	DESCRIPTION	MATERIAL	FINISH/COLOR	FIXED INSTALLATION *		FLEXIBLE INSTALLATION **		DRAG CHAIN	
						MIN.	MAX.	MIN.	MAX.	MIN.	MAX.
X		E02	8X0.25MM;UNSHLD;PVC;BK;OD=6.60MM	PVC	BLACK	-30°C	+80°C	-10°C	+80°C	NOT SUITABLE	
X		B41	CABLE 8X0.25 TPU BK D6.40 TPE UNSH DCS	PUR WSOR	BLACK	-40°C	+90°C	-25°C	+80°C	-5°C	+60°C
X		H08	CABLE PUR;BLK 8X0.25MM-LSOH;UL OD=6.10	PUR-LS0H	BLACK	-40°C	+80°C	-25°C	+80°C	+5°C	+60°C
	X	H45	CABLE 12X0.14BLK PUR D6.0 UL/CSA	PUR	BLACK	-40°C	+80°C	-25°C	+80°C	+5°C	+60°C

CABLE LENGTH TOLERANCES	
LENGTH	TOLERANCE
0m-1m	+40 mm
>1m-5m	+60 mm
>5m-10m	+80 mm
>10m-20m	+140 mm
>20m-30m	+160 mm
>30m	+1% length

* FIXED POSITION WITHOUT ACCIDENTAL CRUSHING OF VIBRATION.
 ** FREE MOTION WITHOUT PERIODIC RECURRENCE OR FORCED GUIDANCE.

A BILL OF MATERIAL:

8P	12P	ITEM	QTY	DESCRIPTION	MATERIAL	FINISH/COLOR
X	X	1	-	CABLE	SEE CABLE LIST	SEE CABLE LIST
X		2	8	CONTACT 8 FE TUR AU CR SHORT 7/8POLE	BRASS	GOLD OVER NICKEL PLATED
	X		12	CONTACT 6 FE TUR NI CR WRA0.14-0.25		
X		3	1	PLG U12 8P AC FE PA UNSH	-	-
	X		1	PLG U12 12P AC FE PA UNSH		
X	X	4	1	OVERMOLD	TPC	SEE MATRIX
IF "H" IS IN MATRIX-END		-	2	I/D CARRIER DIA 4-7MMX30MM	PVC	TRANSPARENT

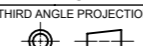
FUNCTIONAL SYMBOLS E/A = 0 E/E = 0 E/V = 0	THIS DRAWING CONTAINS INFORMATION THAT IS PROPRIETARY TO MOLEX ELECTRONIC TECHNOLOGIES, LLC AND SHOULD NOT BE USED WITHOUT WRITTEN PERMISSION	CURRENT REV DESC: NOTES AND CABLE LIST UPDATED			
	THIS DRAWING CONTAINS INFORMATION THAT IS PROPRIETARY TO MOLEX ELECTRONIC TECHNOLOGIES, LLC AND SHOULD NOT BE USED WITHOUT WRITTEN PERMISSION	EC NO: 736602	2023/01/23		
	GENERAL TOLERANCES (UNLESS SPECIFIED)	DRWN: RSCHIEBER	2023/01/31	DOCUMENT NUMBER: 1204000100 DOC TYPE: PSD DOC PART: 000 REVISION: B3	
	ANGULAR TOL ± 1.0°	CHK'D: RSILLER	2023/01/31		
4 PLACES ±	APPR: RSILLER	2023/01/31	MATERIAL NUMBER: 120400 CUSTOMER: GENERAL MARKET SHEET NUMBER: 2 OF 2		
3 PLACES ±					DRAFT WHERE APPLICABLE MUST REMAIN WITHIN DIMENSIONS
2 PLACES ± 0.05			THIRD ANGLE PROJECTION 		
1 PLACE ± 0.3					DRAWING: A3-SIZE SERIES: 120400
0 PLACES ± 0.5			DRAWING: A3-SIZE SERIES: 120400		