

WORLD-BEAM® QS18 Electronically Adjustable Background Suppression Sensor (30-250mm)

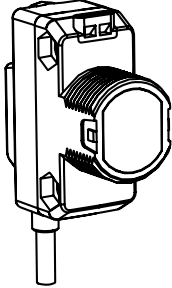

Datasheet

Compact sensors featuring adjustable range background suppression mode



- Two optical designs optimized for reliable long-range target detection and stable detection of colorfully printed packages
 - High visibility red LED spot AF250 model recommended for long range detection to 250 mm on black or white targets
 - Small bright red LED spot AF120 model recommended for reliable detection of colorfully printed packages and small parts or features
- Simple single-turn potentiometer adjustment of cutoff distance
- Enhanced immunity to fluorescent lights
- Crosstalk immunity algorithm allows two sensors to be used in close proximity
- High-intensity, bright red LED spot makes sensor alignment fast and easy
- Convenient mounting options available for 18 mm barrel or side mount
- Bright indicator LEDs show operating status from 360°



WARNING:

- **Do not use this device for personnel protection**
- Using this device for personnel protection could result in serious injury or death.
- This device does not include the self-checking redundant circuitry necessary to allow its use in personnel safety applications. A device failure or malfunction can cause either an energized (on) or de-energized (off) output condition.

Models

Model ¹	Output Type	Sensing Range	Supply Voltage
QS18VN6AF250	Complementary NPN	Adjustable Cutoff: 30 mm to 250 mm	10 V DC to 30 V DC
QS18VP6AF250	Complementary PNP		
QS18K6AF250Q8	IO-Link		
QS18VN6AF120	Complementary NPN	Adjustable Cutoff: 30 mm to 120 mm	
QS18VP6AF120	Complementary PNP		
QS18K6AF120Q8	IO-Link		

Overview

The WORLD-BEAM® QS18 Sensor with Background Suppression detects targets within the cutoff distance while ignoring objects in the background. Background suppression mode is recommended when target position is repeatable, but target color and background conditions vary.

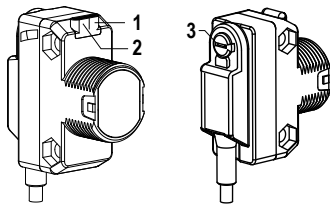

- 1 Green LED: Power Indicator
- 2 Amber LED: Light Sensed Indicator (Flashes for Marginal Conditions)
- 3 Cutoff Point Adjustment Potentiometer

¹ 2 m (6.5 ft) PVC cabled models are listed for the complementary output models. 2 m (6.5 ft) and 9 m (30 ft) PVC cabled options are not available on IO-Link models.

- To order the 9 m (30 ft) PVC cable model, add the suffix "W/30" to the cabled model number. For example, QS18VN6AF250 W/30.
- To order the 4-pin M12 integral quick disconnect model, add the suffix "Q8" to the model number. For example, QS18VN6AF250Q8.
- To order the 4-pin M8 integral quick disconnect model, add the suffix "Q7" to the model number. For example, QS18VN6AF250Q7.
- To order the 150 mm (6 in) PVC cable model with a 4-pin M12 quick disconnect, add the suffix "Q5" to the model number. For example, QS18VN6AF250Q5.
- To order the 150 mm (6 in) PVC cable model with a 4-pin M8 quick disconnect, add the suffix "Q" to the model number. For example, QS18VN6AF250Q.
- Models with a quick disconnect require a mating cordset.



Installation Instructions

Sensor Orientation

Optimize detection reliability and minimum object separation performance with correct sensor-to-target orientation. To ensure reliable detection, orient the sensor as shown in relation to the target to be detected.

Figure 1. Optimal Orientation of Target to Sensor

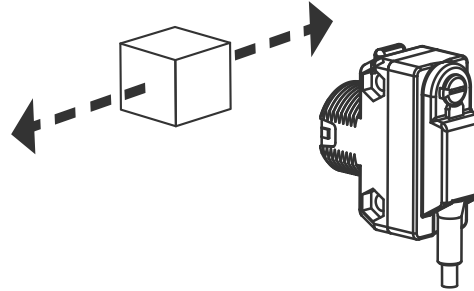

Wiring Diagrams

Cabled wiring diagrams are shown. Quick disconnect wiring diagrams are functionally identical.

Figure 2. NPN output

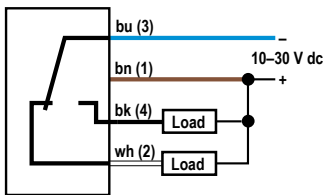

Figure 3. PNP output

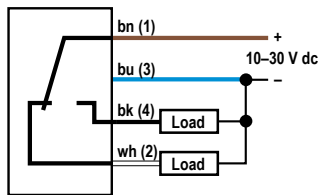

Figure 4. IO-Link with PNP output

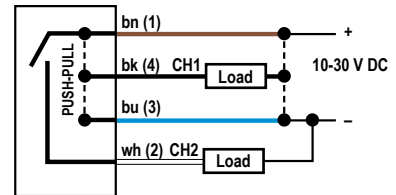

Figure 5. 4-pin male M12 pinout

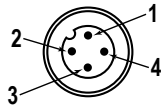

Figure 6. 4-pin male M8 pinout



Key

- 1 = Brown
- 2 = White
- 3 = Blue
- 4 = Black

Sensor Setup

Background Suppression Mode: Objects beyond the set cutoff distance will not be detected. Background suppression mode can be used in most situations with varying object colors and positions or with varying background conditions.

To ensure reliable background suppression, a minimum separation distance between the object and the background is necessary. See [Figure 8](#) on page 5 for AF250 models or [Figure 9](#) on page 5 for AF120 models to determine the minimum separation distance.

1. Mount the sensor with the darkest object at the longest application distance. The distance to the object must be less than shown in [Figure 8](#) on page 5, or [Figure 9](#) on page 5 for your object color, depending on the model.
2. Turn the adjustment potentiometer counter-clockwise until the yellow indicator turns off.
3. Turn the adjustment potentiometer clockwise until the yellow indicator turns on.
4. Replace the darkest object with the brightest background at the closest application distance.
5. Turn the adjustment potentiometer clockwise until the yellow indicator turns on.
6. Turn the adjustment potentiometer counter-clockwise approximately half of the adjustment rotation from step 5. This places the cutoff distance approximately half-way between the object and the background switch points.

If sufficient separation exists between the object and background, the sensor is ready for operation.

Figure 7. Minimum Separation Distance

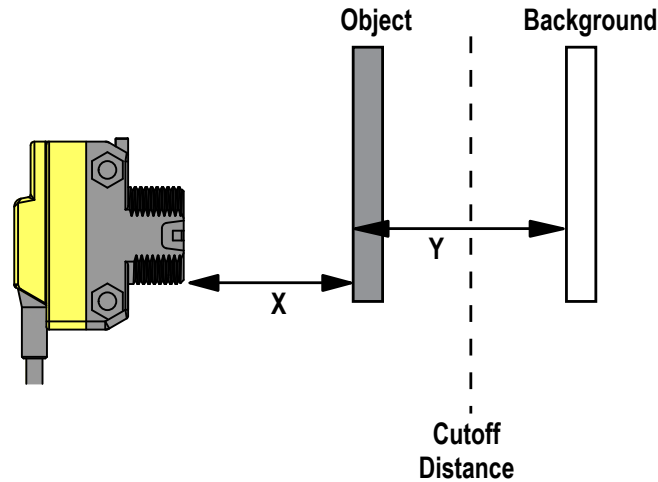

X: Distance to the Object

Y: Minimum Separation Between the Object and the Background

Set the cutoff distance approximately midway between the farthest object and the closest background

IO-Link Interface

IO-Link is a point-to-point communication link between a master device and sensor. Use IO-Link to parameterize sensors and transmit process data automatically.

For the latest IO-Link protocol and specifications, see www.io-link.com.

Each IO-Link device has an IODD (IO Device Description) file that contains information about the manufacturer, article number, functionality etc. This information can be easily read and processed by the user. Each device can be unambiguously identified via the IODD as well as via an internal device ID. Download the QS18's IO-Link IODD package (p/n 206635) from Banner Engineering's website at www.bannerengineering.com.

Banner has also developed Add On Instruction (AOI) files to simplify ease-of-use between the QS18, multiple third-party vendors' IO-Link masters, and the Logix Designer software package for Rockwell Automation PLCs. Three types of AOI files for Rockwell Allen-Bradley PLCs are listed below. These files and more information can be found at www.bannerengineering.com.

Process Data AOIs—These files can be used alone, without the need for any other IO-Link AOIs. The job of a Process Data AOI is to intelligently parse out the Process Data word(s) in separate pieces of information. All that is required to make use of this AOI is an EtherNet/IP connection to the IO-Link Master and knowledge of where the Process Data registers are located for each port.

Parameter Data AOIs—These files require the use of an associated IO-Link Master AOI. The job of a Parameter Data AOI, when working in conjunction with the IO-Link Master AOI, is to provide quasi-realtime read/write access to all IO-Link parameter data in the sensor. Each Parameter Data AOI is specific to a given sensor or device.

IO-Link Master AOIs—These files require the use of one or more associated Parameter Data AOIs. The job of an IO-Link Master AOI is to translate the desired IO-Link read/write requests, made by the Parameter Data AOI, into the format a specific IO-Link Master requires. Each IO-Link Master AOI is customized for a given brand of IO-Link Master.

Add and configure the relevant Banner IO-Link Master AOI in your ladder logic program first; then add and configure Banner IO-Link Device AOIs as desired, linking them to the Master AOI as shown in the relevant AOI documentation.

Specifications

Supply Voltage

10 V DC to 30 V DC (10% maximum ripple within specified limits)

Maximum Power Consumption (exclusive of load)

AF120 Models less than 300 mW
AF250 Models less than 475 mW

Sensing Beam

Visible red LED, 640 nm

Supply Protection Circuitry

Protected against reverse polarity and transient voltages

Output Configuration

Solid-state complementary: NPN or PNP, or push/pull, depending on model

Rating: 50 mA per output

Output Voltage High: Greater than $V_{supply} - 2.5 V$

Output Voltage Low: Less than 2.5 V

For loads less than 1 Meg Ohm

Protected against false pulse on power-up and continuous overload or short circuit of outputs

Connections

2 m (6.5 ft) unterminated 4-wire PVC cable; 9 m (30 ft) unterminated 4-wire PVC cable; 150 mm (6 in) PVC cable with a 4-pin M8 male quick-disconnect connector; 150 mm (6 in) PVC cable with a 4-pin M12 male quick-disconnect connector; Integral 4-pin M8 male quick-disconnect connector or Integral 4-pin M12 male quick-disconnect connector, depending on model

Models with a quick disconnect require a mating cordset

IO-Link Interface

Supports Smart Sensor Profile: Yes

Baud Rate: 38400 bps

Process Data Widths: 16 bits

IODD Files: Provides all programming options plus additional functionality; please see the IO-Link Data Reference Guide for more details

Environmental Rating

IEC IP67; NEMA 6; UL Type 1

Operating Conditions

95% relative humidity at 50 °C (non-condensing)

-40 °C to +60 °C (-40 °F to +140 °F)

Certifications



Banner Engineering Europe
Park Lane, Culliganlaan 2F
bus 3, 1831 Diegem,
BELGIUM



Turck Banner LTD Blenheim
House, Blenheim Court,
Wickford, Essex SS11 8YT,
Great Britain

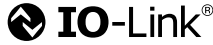

Output Response

1.7 milliseconds ON; 1.1 milliseconds OFF

Note: 200 millisecond delay on power-up; outputs do not conduct during this time

Adjustments

Single-turn adjustment potentiometer sets the cutoff distance between minimum and maximum positions

Repeatability

130 μs (standard mode)

Indicators

2 LED indicators on sensor top:

Green solid: Power on

Amber: Light sensed

Amber flashing: Marginal sensing condition

Construction

ABS housing, acrylic lens cover, nickel-plated brass connector, acetal adjustment pot

Required Overcurrent Protection



WARNING: Electrical connections must be made by qualified personnel in accordance with local and national electrical codes and regulations.

Overcurrent protection is required to be provided by end product application per the supplied table.

Overcurrent protection may be provided with external fusing or via Current Limiting, Class 2 Power Supply.

Supply wiring leads < 24 AWG shall not be spliced.

For additional product support, go to www.bannerengineering.com.

Supply Wiring (AWG)	Required Overcurrent Protection (Amps)
20	5.0
22	3.0
24	2.0
26	1.0
28	0.8
30	0.5

Performance Curves

Long Range: The minimum sensing range is 8 mm for 6% reflectivity. Short Range: The minimum sensing range is 13 mm for 6% reflectivity.

Figure 8. Minimum separation between object and background (Background Suppression Mode) for AF250 models

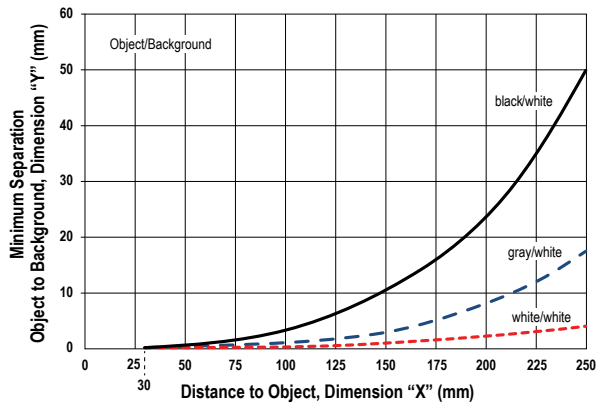

Figure 9. Minimum separation between object and background (Background Suppression Mode) for AF120 models

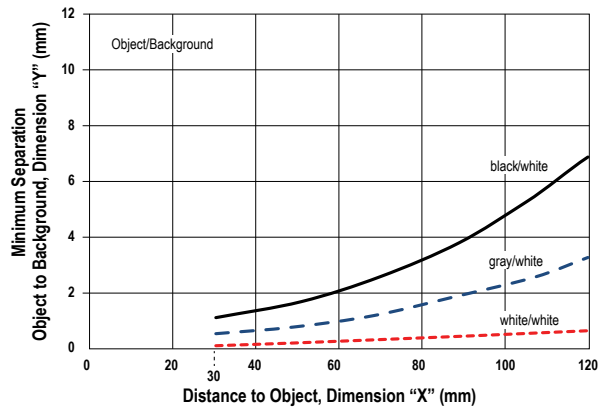
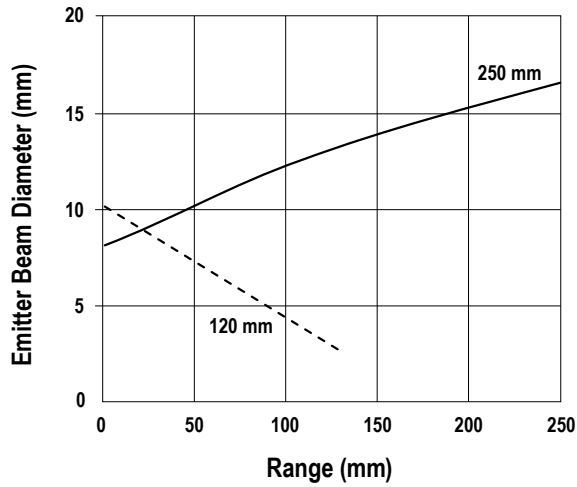

Figure 10. Typical emitter spot diameter vs. distance for AF250 and AF120



Dimensions

All measurements are listed in millimeters, unless noted otherwise.

Figure 11. Base dimensions for the QS18 models

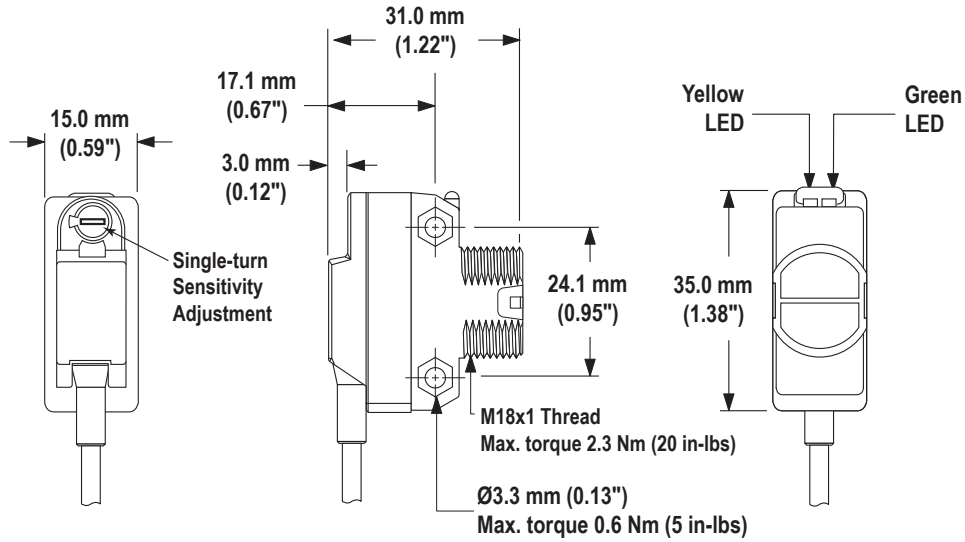
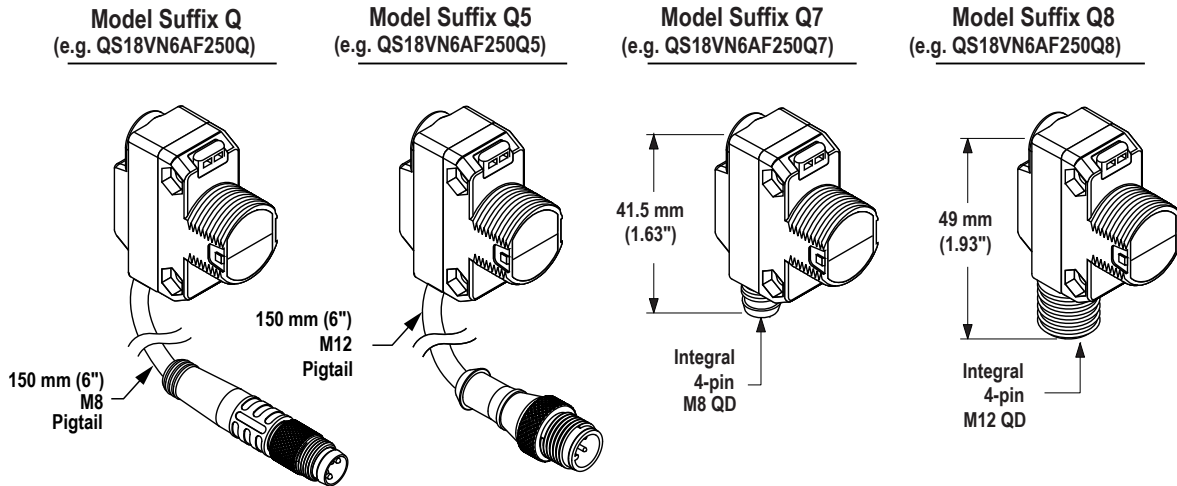

Figure 12. Dimensions for each connection type



Accessories

Brackets

SMB18A

- Right-angle mounting bracket with a curved slot for versatile orientation
- 12-ga. stainless steel
- 18 mm sensor mounting hole
- Clearance for M4 (#8) hardware

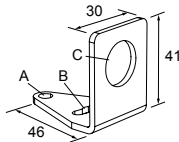

Hole center spacing: A to B = 24.2

Hole size: A = \varnothing 4.6, B = 17.0 x 4.6, C = \varnothing 18.5

SMBQS18Y

- Die-cast bracket for 18 mm holes
- Includes metal hex nut and lock washer
- Allows $\pm 8^\circ$ for cabled sensors

Hole size: A = \varnothing 15.3

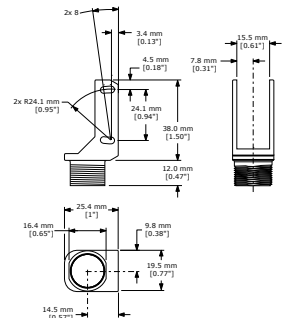

SMBQ4X..

- Swivel bracket with tilt and pan movement for precision adjustment
- Easy sensor mounting to extruded rail T-slots
- Metric and inch size bolts available
- Side mounting of some sensors with the 3 mm screws included with the sensor

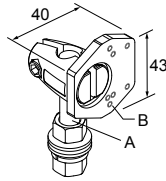

B = 7 × M3 × 0.5

Model	Bolt Thread (A)
SMBQ4XFA	3/8 - 16 × 2¼ in
SMBQ4XFAM10	M10 - 1.5 × 50
SMBQ4XFAM12	n/a; no bolt included. Mounts directly to 12 mm (½ in) rods

SMB18AFA..

- Protective, swivel bracket with tilt and pan movement for precision adjustment
- Easy sensor mounting to extruded rail T-slots
- Metric and inch size bolts available
- Mounting hole for 18 mm sensors

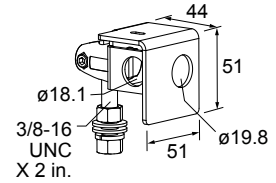

Hole size: B = ø 18.1

Model	Bolt Thread (A)
SMB18AFA	3/8 - 16 × 2 in
SMB18AFAM10	M10 - 1.5 × 50

SMB312S

- Stainless steel 2-axis, side-mount bracket

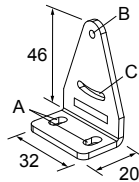

A = 4.3 × 7.5, B = diam. 3, C = 3 × 15.3

Cordsets

4-Pin Threaded M12 Cordsets—Single Ended					
Model	Length	Style	Dimensions	Pinout (Female)	
MQDC-406	2 m (6.56 ft)	Straight			1 = Brown 2 = White 3 = Blue 4 = Black 5 = Unused
MQDC-415	5 m (16.4 ft)				
MQDC-430	9 m (29.5 ft)				
MQDC-450	15 m (49.2 ft)				
MQDC-406RA	2 m (6.56 ft)	Right-Angle			1 = Brown 2 = White 3 = Blue 4 = Black 5 = Unused
MQDC-415RA	5 m (16.4 ft)				
MQDC-430RA	9 m (29.5 ft)				
MQDC-450RA	15 m (49.2 ft)				

4-Pin Threaded M8 Cordsets—Single Ended					
Model	Length	Style	Dimensions	Pinout (Female)	
PKG4M-2	2.04 m (6.68 ft)	Straight			1 = Brown 2 = White 3 = Blue 4 = Black
PKG4M-5	5 m (16.4 ft)				
PKG4M-9	9.04 m (29.6 ft)				

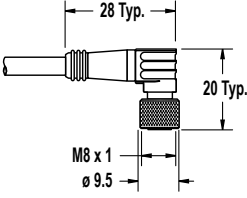
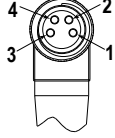
4-Pin Threaded M8 Cordsets—Single Ended				
Model	Length	Style	Dimensions	Pinout (Female)
PKW4M-2	2 m (6.56 ft)	Right Angle		
PKW4M-5	5 m (16.4 ft)			
PKW4M-9	9 m (29.5 ft)			

Banner Engineering Corp. Limited Warranty

Banner Engineering Corp. warrants its products to be free from defects in material and workmanship for one year following the date of shipment. Banner Engineering Corp. will repair or replace, free of charge, any product of its manufacture which, at the time it is returned to the factory, is found to have been defective during the warranty period. This warranty does not cover damage or liability for misuse, abuse, or the improper application or installation of the Banner product.

THIS LIMITED WARRANTY IS EXCLUSIVE AND IN LIEU OF ALL OTHER WARRANTIES WHETHER EXPRESS OR IMPLIED (INCLUDING, WITHOUT LIMITATION, ANY WARRANTY OF MERCHANTABILITY OR FITNESS FOR A PARTICULAR PURPOSE), AND WHETHER ARISING UNDER COURSE OF PERFORMANCE, COURSE OF DEALING OR TRADE USAGE.

This Warranty is exclusive and limited to repair or, at the discretion of Banner Engineering Corp., replacement. **IN NO EVENT SHALL BANNER ENGINEERING CORP. BE LIABLE TO BUYER OR ANY OTHER PERSON OR ENTITY FOR ANY EXTRA COSTS, EXPENSES, LOSSES, LOSS OF PROFITS, OR ANY INCIDENTAL, CONSEQUENTIAL OR SPECIAL DAMAGES RESULTING FROM ANY PRODUCT DEFECT OR FROM THE USE OR INABILITY TO USE THE PRODUCT, WHETHER ARISING IN CONTRACT OR WARRANTY, STATUTE, TORT, STRICT LIABILITY, NEGLIGENCE, OR OTHERWISE.**

Banner Engineering Corp. reserves the right to change, modify or improve the design of the product without assuming any obligations or liabilities relating to any product previously manufactured by Banner Engineering Corp. Any misuse, abuse, or improper application or installation of this product or use of the product for personal protection applications when the product is identified as not intended for such purposes will void the product warranty. Any modifications to this product without prior express approval by Banner Engineering Corp will void the product warranties. All specifications published in this document are subject to change; Banner reserves the right to modify product specifications or update documentation at any time. Specifications and product information in English supersede that which is provided in any other language. For the most recent version of any documentation, refer to: www.bannerengineering.com.

For patent information, see www.bannerengineering.com/patents.