

6

5

4

3

2

1

APPROVED: \_\_\_\_\_

DATE: \_\_\_\_\_ TITLE: \_\_\_\_\_

Rev	AWO #	Description	Date	Appr
-		RELEASED	9/25/20	

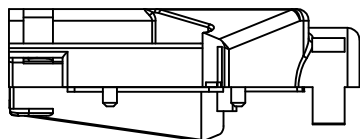
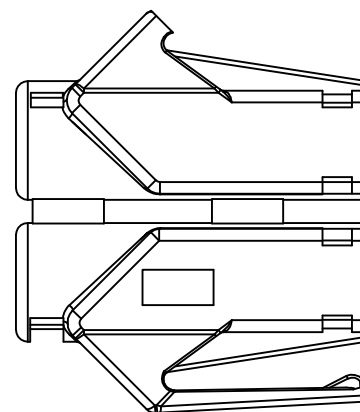
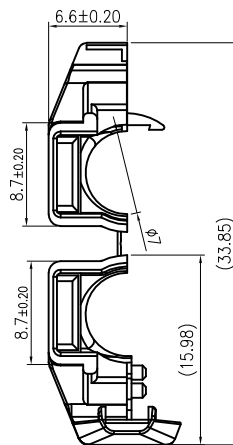
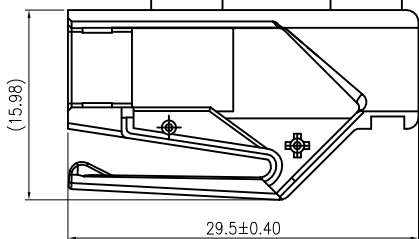
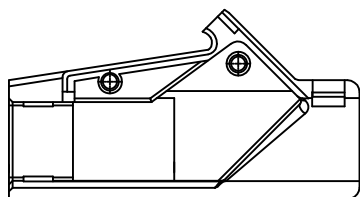
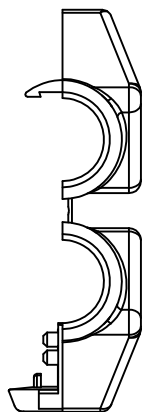
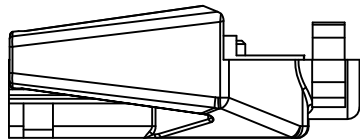

UNLESS OTHERWISE SPECIFIED  
 ALL DIMENSIONS ARE MILLIMETERS  
 TOLERANCES: EXCEPT AS NOTED

0~15	± 0.15	ANGLE	± 1°
15~30	± 0.20		
30~	± 0.25		

**ADAM**  
**TECH**  
 INTERCONNECTS

909 Rahway Avenue,  
 Union, NJ 07083  
 Phone: 908-687-5000  
 Fax: 908-687-5710

SPECIFICATIONS:  
 Material:  
 Insulator: PA66, Glass reinforced, Color: Black  
 Environmental:  
 Lead free, RoHS compliant



APPROVALS		DATE
DRAWN	LH	9/25/20
CHECKED	AY1	9/25/20
APPROVED		

TITLE		
MODULAR TELEPHONE PLUG, PLASTIC HOOD		
SIZE	PART NO.	REV.
X	MTP-88-HD-A	-
REF: S00005C	SCALE: NTS	SHEET 1 OF 1

6

5

4

3

2

1