

Ordering Information

UL recognized sockets are shaded

	A2 / A9	J114FL / J114AF	J151 2C	J151 3C	J151 4C	J152 2C	J152 3C	J152 4C
Panel Mount / Wire Assembly	HD-1001 HD-1002 HD-1004		PT08			PY08	PY11	PY14
PC Pin	HD-1003	P2R05P P2R08P	PT08-0	PT11A		PY08-02	PY11-02	PY14-02
DIN Rail Mountable		P2F08S	PTF08A	PTF11A	PTF14A	PYF08A	PYF11A	PYF14A
DIN Rail Mountable Finger Safe		P2F08N	PTF08A-E			PYF08A-E	PYF11A-E	PYF14A-E

Dimensions

Units = mm

HD-1001

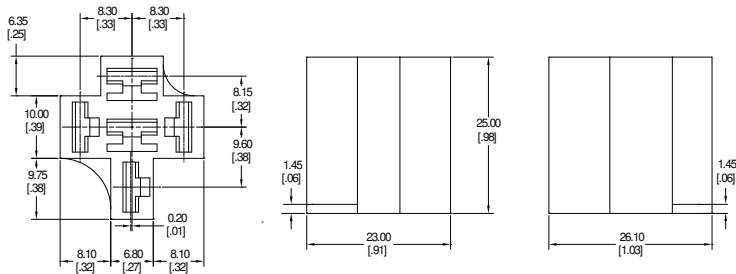

** The recommended female quick connects are AMP / Tyco :
 • 60249-1 (12-16 AWG) or equivalent
 • 42281-1 (14-18 AWG) or equivalent



HD-1002

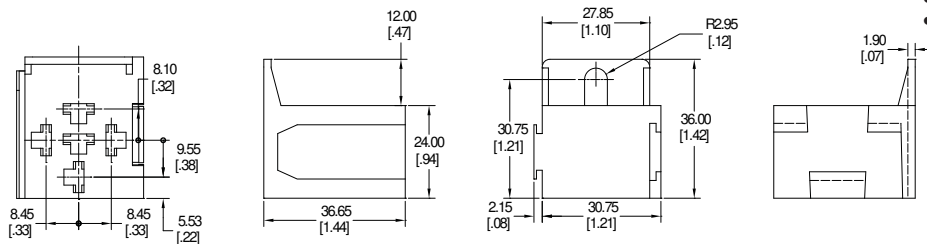

** The recommended female quick connects are AMP / Tyco :
 • 60249-1 (12-16 AWG) or equivalent
 • 42281-1 (14-18 AWG) or equivalent



HD-1003

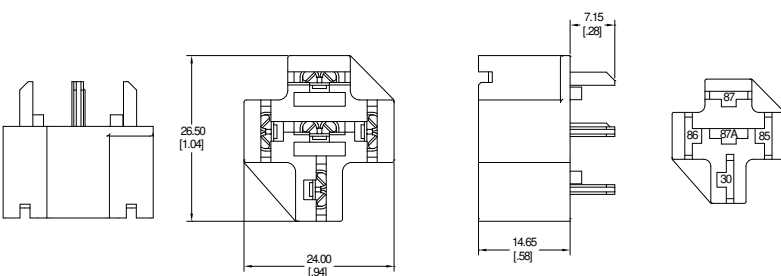

PCB Layout

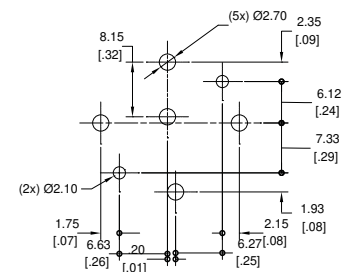

Socket

Dimensions

Units = mm

HD-1004 Combination of five wire grommets required for HD-1004

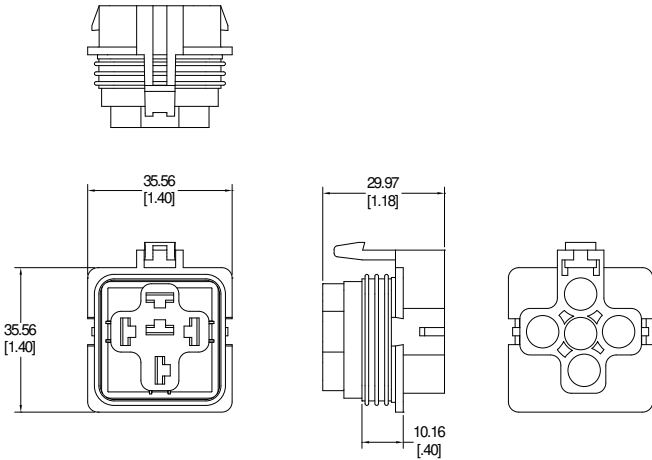

HD-1004 Wire Grommet - HDWGA (18AWG)

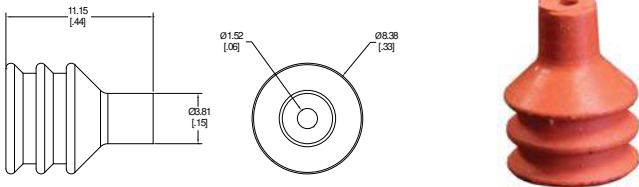

HD-1004 Wire Grommet - HDWGB (14-16 AWG)

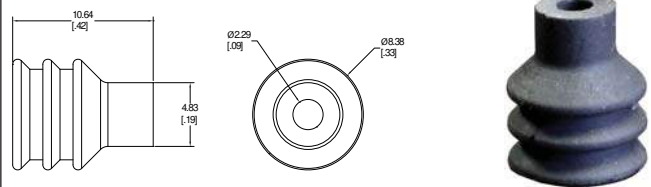

HD-1004 Wire Grommet - HDWGC (12AWG)

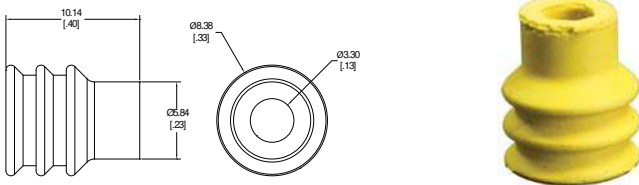

HD-1004 Wire Grommet - HDWGD (Plug)

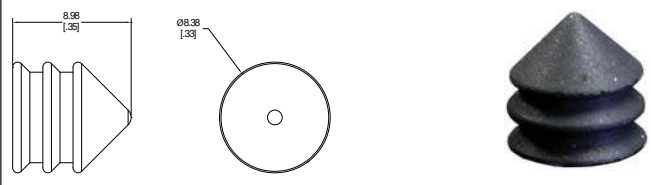

***Recommended female quick connect terminals**
TE Connectivity 60253 (12-16AWG)
TE Connectivity 42100 (14-18AWG)

Dimensions

Units = mm

P2F08N

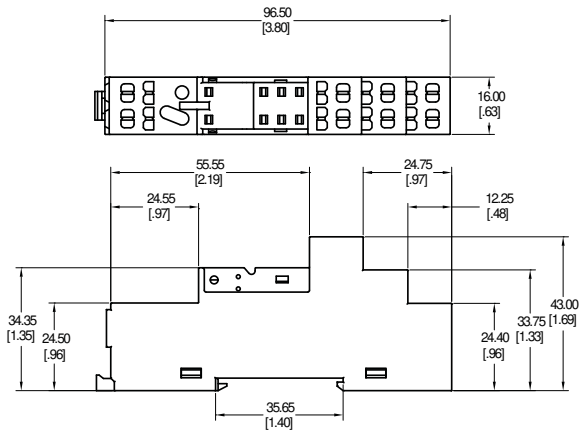

Schematic

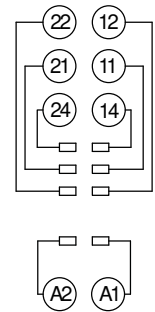

P2F08S

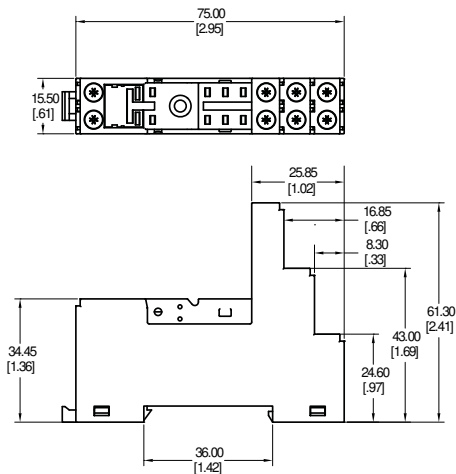

Schematic

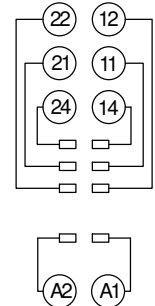

P2R05P

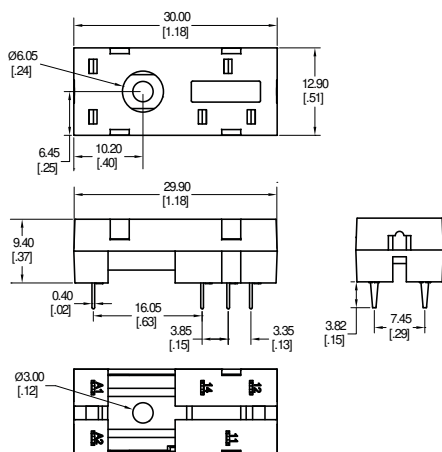

PCB Layout

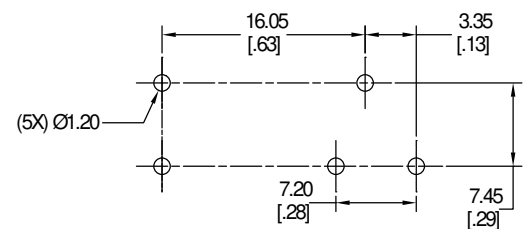

Socket

Dimensions

Units = mm

P2R08P

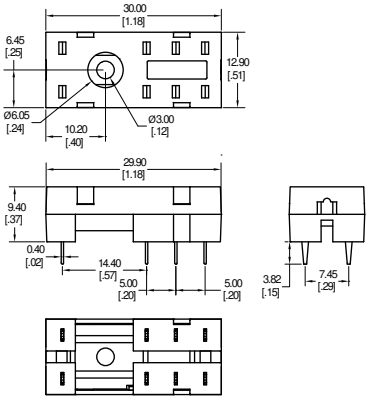

PCB Layout

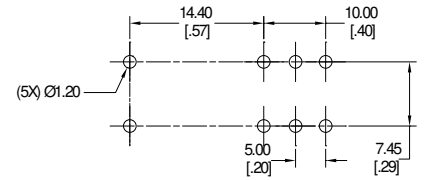

PT08

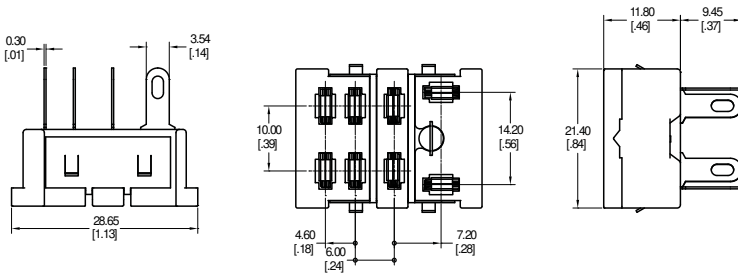

Panel Cut-Out

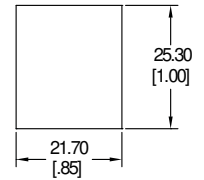

PT08-0

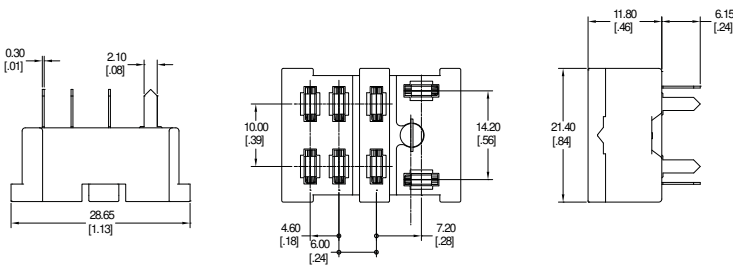

PCB Layout

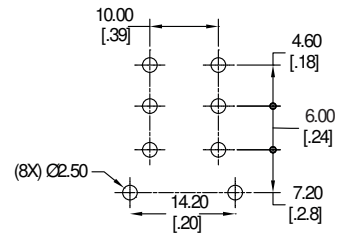

PT11A

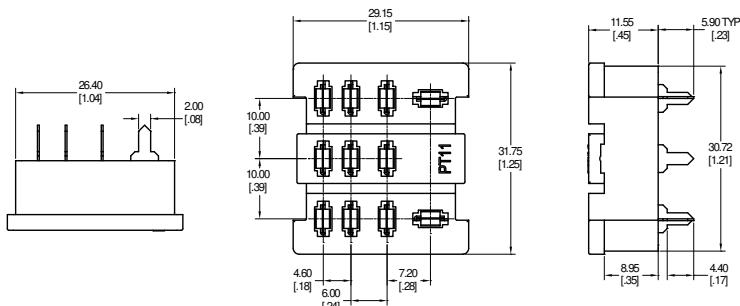

PCB Layout

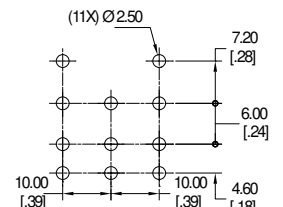

Dimensions

Units = mm

PTF08A

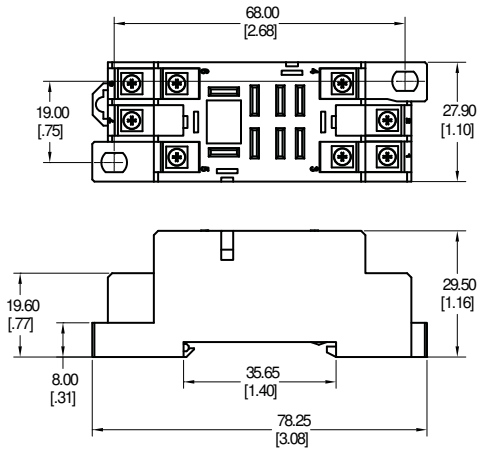

Schematic

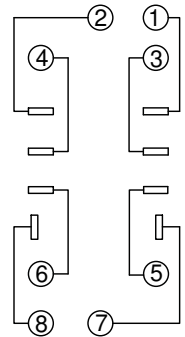

PTF08A-E

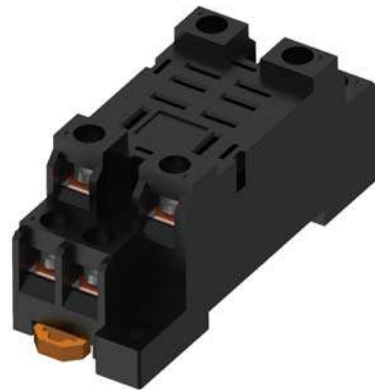
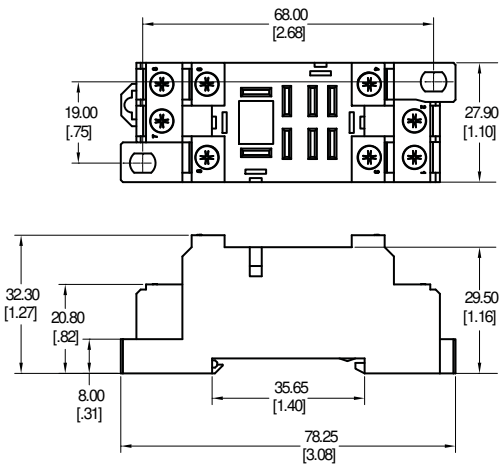

Schematic

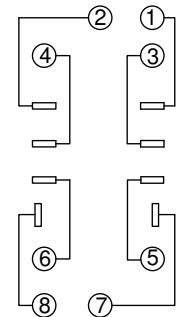

PTF11A

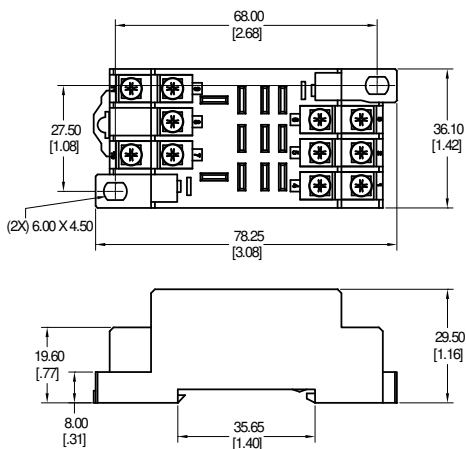

Schematic

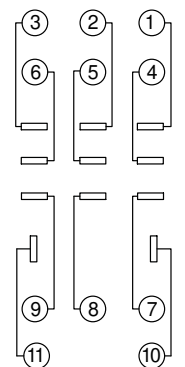

Socket

Dimensions

Units = mm

PTF14A

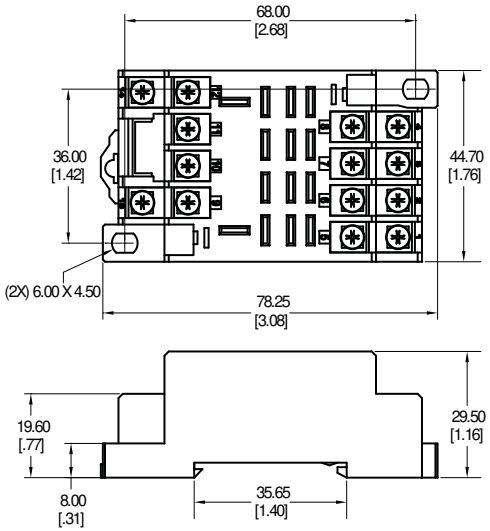

Schematic

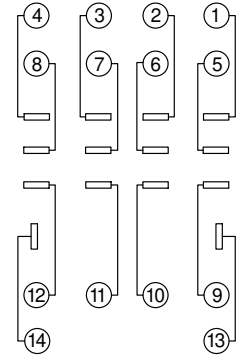

PY08

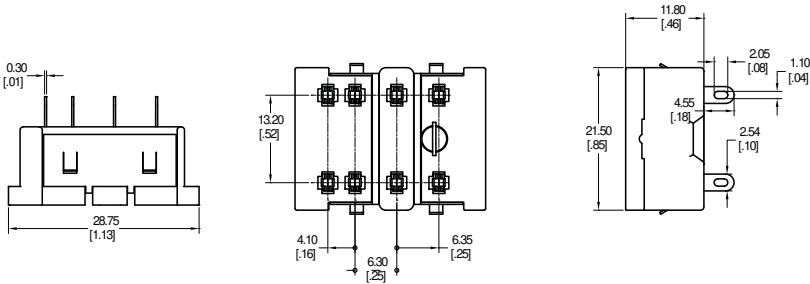

Panel Cut-Out

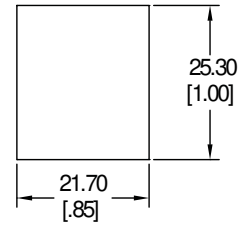

PY08-02

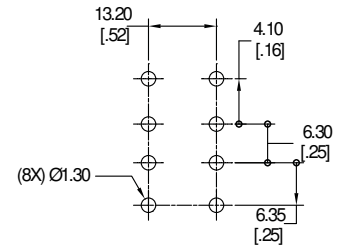
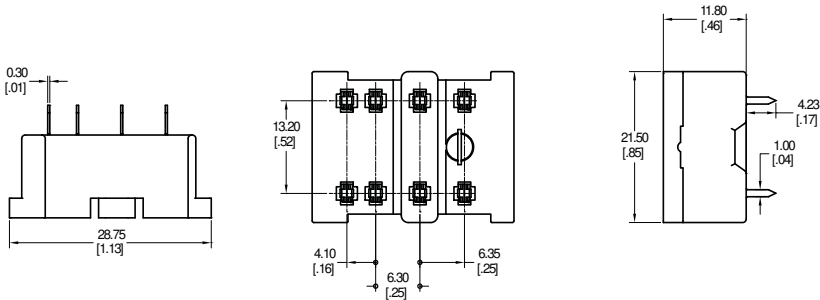

Dimensions

Units = mm

PY11

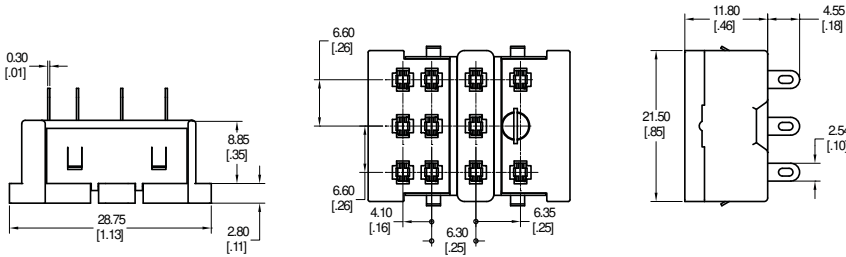

Panel Cut-Out

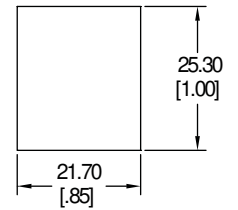

PY11-02

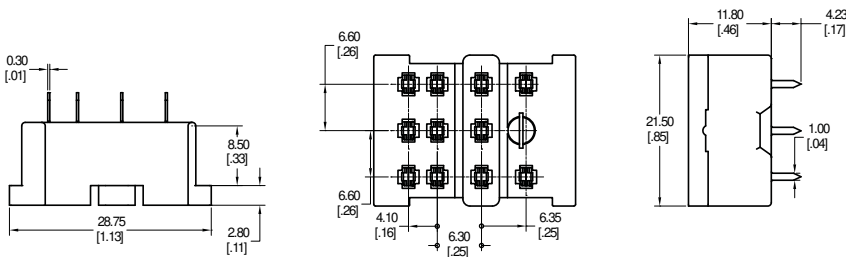

PCB Layout

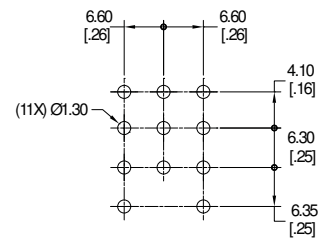

PY14

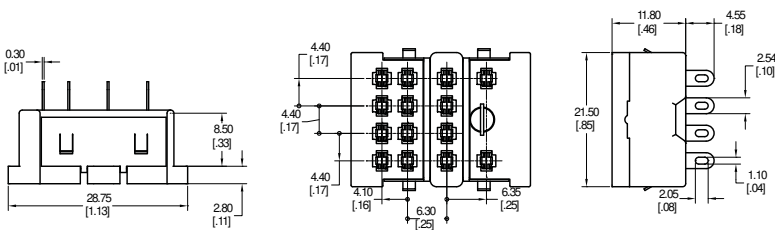

Panel Cut-Out

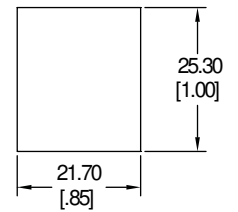

PY14-02

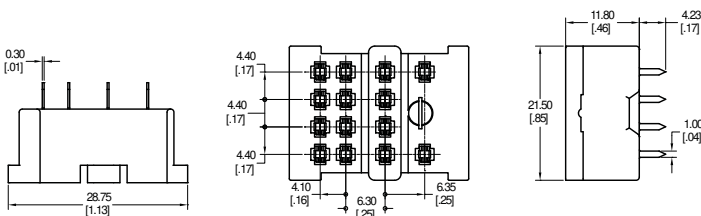

PCB Layout

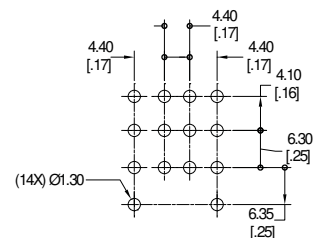

Socket

Dimensions

Units = mm

PYF08A

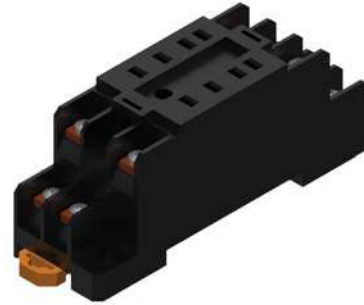
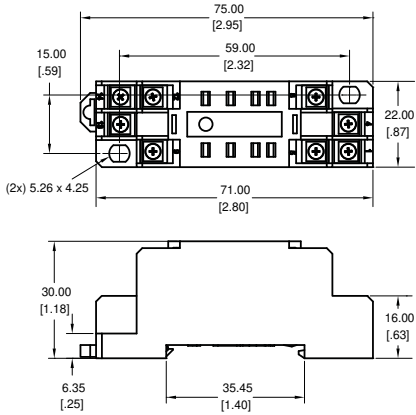

Schematic

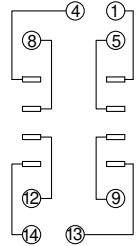

PYF08A-E

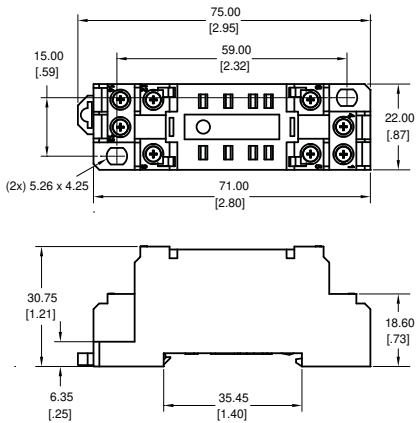

Schematic

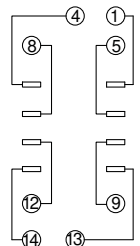

PYF11A

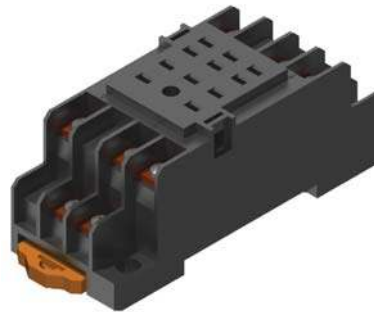
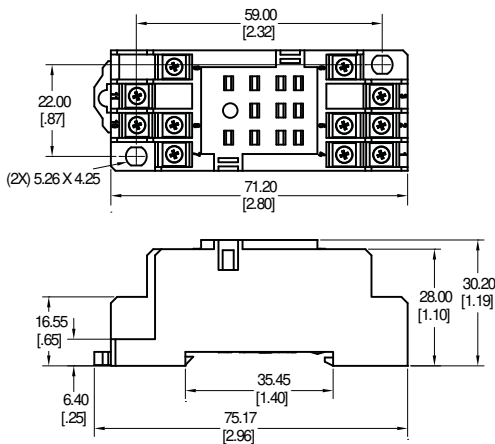

Schematic

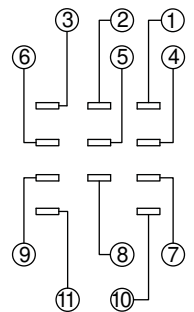

Dimensions

Units = mm

PYF11A-E

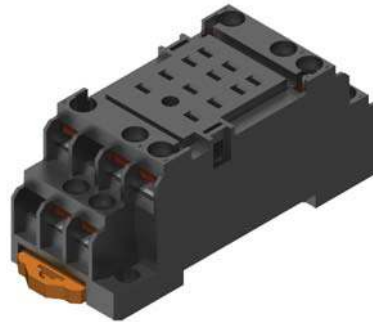
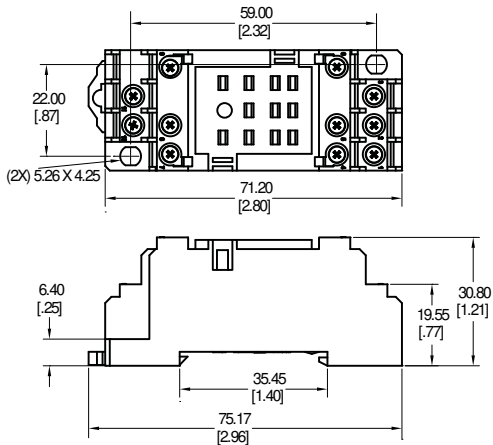

Schematic

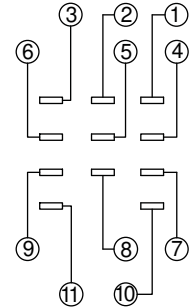

PYF14A

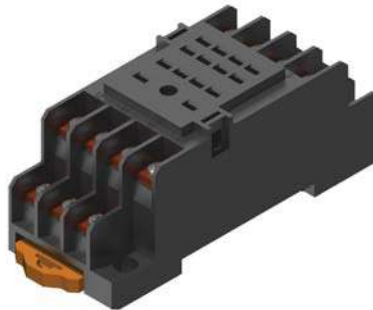
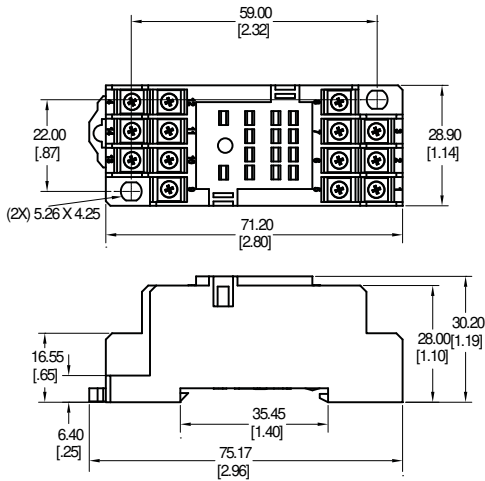

Schematic

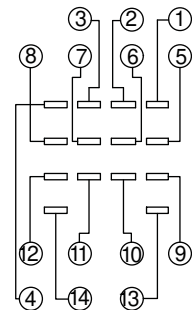

PYF14A-E

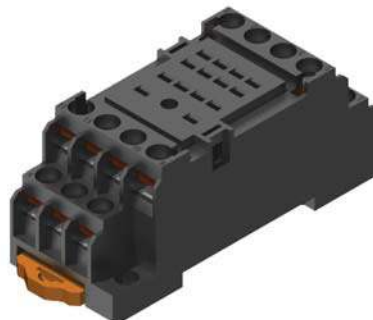
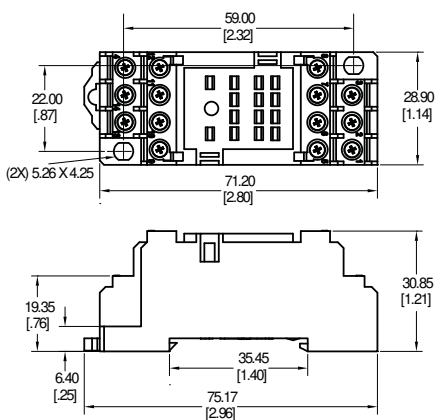

Schematic

