



### DC/DC CONVERTER

- 88-360Vdc Wide-range Input
- Width only 65mm
- Efficiency up to 94.6%
- ATEX and IECEx Approved
- Excellent Partial Load Efficiency
- 20% Output Power Reserves
- Safe Hiccup<sup>PLUS</sup> Overload Mode
- Easy Fuse Tripping due to High Overload Current (typ. 45A for 15ms)
- Minimal Inrush Current Surge
- Full Power Between -25°C and +60°C
- DC-OK Relay Contact
- Reverse Input Polarity Protected
- Current Sharing Feature for Parallel Use
- 3 Year Warrant

### GENERAL DESCRIPTION

The Dimension C-Series are cost optimized power supplies and DC/DC converters without compromising quality, reliability and performance. The C-Series is part of the DIMENSION power supply family. The most outstanding features of CPS20.481-D1 are the wide DC-input range, high efficiency, electronic inrush current limitation, wide operational temperature range.

The C-Series includes all the essential basic functions. The devices have a power reserve of 20% included, which may even be used continuously at temperatures up to +45°C. Additionally, the CPS20.481-D1 can deliver about 4 times the nominal output current for 15ms which helps to trip fuses on faulty output branches.

High immunity to transients and power surges as well as low electromagnetic emission, a DC-OK relay contact and a large international approval package for a variety of applications makes this unit suitable for nearly every situation.

### SHORT-FORM DATA

Output voltage	DC 48V	
Adjustment range	48 - 56V	
Output current	10A	at 48V, amb <60°C
	12A	at 48V, amb <45°C
	8.6A	at 56V, amb <60°C
	10.3A	at 56V, amb <45°C
Output power	480W	ambient <60°C
	576W	ambient <45°C
Output ripple	< 50mVpp	20Hz to 20MHz
AC Input voltage	-	-
DC Input voltage	DC 110-300V	± 20%
DC Input current	4.68 / 1.69A	at 110 / 300Vdc
Inrush current	typ. 6 / 4A peak	at 110 / 300Vdc
Efficiency	93.1 / 94.6%	at 110 / 300Vdc
Losses	35.6 / 27.4W	at 110 / 300Vdc
Temperature range	-25°C to +70°C	operational
Derating	12W/°C	+60 to +70°C
Hold-up time	typ. 26 / 26ms	at 110 / 300Vdc
Dimensions	65x124x127mm WxHxD	
Weight	940g 2.1lb	

### ORDER NUMBERS

DC/DC converter **CPS20.481-D1** 48-56V Standard unit

Accessory	ZM2.WALL	Wall mount bracket
	ZM13.SIDE	Side mount bracket
	YR40.482	Redundancy module

### MARKINGS



### INDEX

	Page		Page
1. Intended Use .....	3	20. Physical Dimensions and Weight .....	18
2. Installation Requirements .....	3	21. Accessories .....	19
3. AC-Input .....	4	21.1. ZM2.WALL - Wall Mounting Bracket .....	19
4. DC-Input .....	4	21.2. ZM13.SIDE - Side Mounting Bracket .....	19
5. Input Inrush Current .....	5	21.3. Redundancy Modules .....	20
6. Output .....	6	22. Application Notes .....	21
7. Hold-up Time .....	8	22.1. Peak Current Capability .....	21
8. DC-OK Relay Contact .....	8	22.2. Back-feeding Loads .....	21
9. Efficiency and Power Losses .....	9	22.3. External Input Protection .....	22
10. Lifetime Expectancy and MTBF .....	10	22.4. Output Circuit Breakers .....	22
11. Functional Diagram .....	10	22.5. Parallel Use to Increase Output Power .....	23
12. Terminals and Wiring .....	11	22.6. Parallel Use for Redundancy .....	23
13. Front Side and User Elements .....	12	22.7. Series Operation .....	24
14. EMC .....	13	22.8. Inductive and Capacitive Loads .....	24
15. Environment .....	14	22.9. Charging of Batteries .....	25
16. Protection Features .....	15	22.10. Use in a Tightly Sealed Enclosure .....	25
17. Safety Features .....	15	22.11. Mounting Orientations .....	26
18. Dielectric Strength .....	16		
19. Approvals .....	17		

The information presented in this document is believed to be accurate and reliable and may change without notice. No part of this document may be reproduced or utilized in any form without permission in writing from the publisher.

### TERMINOLOGY AND ABBREVIATIONS

<b>PE and <math>\oplus</math> symbol</b>	PE is the abbreviation for <b>Protective Earth</b> and has the same meaning as the symbol $\oplus$ .
<b>Earth, Ground</b>	This document uses the term "earth" which is the same as the U.S. term "ground".
<b>T.b.d.</b>	To be defined, value or description will follow later.
<b>DC 300V</b>	A figure displayed with the AC or DC before the value represents a nominal voltage with standard tolerances (usually $\pm 15\%$ ) included. E.g.: DC 12V describes a 12V battery disregarding whether it is full (13.7V) or flat (10V)
<b>300Vdc</b>	A figure with the unit (Vdc) at the end is a momentary figure without any additional tolerances included.
<b>may</b>	A key word indicating flexibility of choice with no implied preference.
<b>shall</b>	A key word indicating a mandatory requirement.
<b>should</b>	A key word indicating flexibility of choice with a strongly preferred implementation.

### 1. INTENDED USE

This device is designed for installation in an enclosure and is intended for the general professional use such as in industrial control, office, communication, and instrumentation equipment.

Do not use this DC/DC converter in equipment, where malfunction may cause severe personal injury or threaten human life.

This device is designed for use in hazardous, non-hazardous, ordinary or unclassified locations.

### 2. INSTALLATION REQUIREMENTS

This device may only be installed and put into operation by qualified personnel.

This device does not contain serviceable parts. The tripping of an internal fuse is caused by an internal defect.

If damage or malfunction should occur during installation or operation, immediately turn power off and send unit to the factory for inspection.

Mount the unit on a DIN-rail so that the terminals are located on the bottom of the unit. For other mounting orientations see de-rating requirements in this document. See chapter 24.13.

This device is designed for convection cooling and does not require an external fan. Do not obstruct airflow and do not cover ventilation grid (e.g. cable conduits) by more than 15%!

Keep the following installation clearances: 40mm on top, 20mm on the bottom, 5mm on the left and right sides are recommended when the device is loaded permanently with more than 50% of the rated power. Increase this clearance to 15mm in case the adjacent device is a heat source (e.g. another power supply).

A disconnecting means shall be provided for the output of the power supplies when used in applications according to CSA C22.2 No 107.1-01.

**⚠ WARNING** Risk of electrical shock, fire, personal injury or death.

- Do not use the DC/DC converter without proper grounding (Protective Earth). Use the terminal on the input block for earth connection and not one of the screws on the housing.
- Turn power off before working on the device. Protect against inadvertent re-powering.
- Make sure that the wiring is correct by following all local and national codes.
- Do not modify or repair the unit.
- Do not open the unit as high voltages are present inside.
- Use caution to prevent any foreign objects from entering the housing.
- Do not use in wet locations or in areas where moisture or condensation can be expected.
- Do not touch during power-on, and immediately after power-off. Hot surfaces may cause burns.

#### Notes for use in hazardous location areas:

The power supply is suitable for use in Class I Division 2 Groups A, B, C, D locations and for use in Group II Category 3 (Zone 2) environments and are evaluated according to EN 60079-0:2012 and EN 60079-15:2010.

#### WARNING EXPLOSION HAZARDS!

Substitution of components may impair suitability for this environment. Do not disconnect the unit or operate the voltage adjustment or S/P jumper unless power has been switched off or the area is known to be non-hazardous.

### 3. AC-INPUT

Do not operate this DC/DC converter with AC-input voltage. Use the CPS20.241 unit instead.

### 4. DC-INPUT

Use a battery or a similar DC source. A supply from the intermediate DC-bus of a frequency converter is not recommended and can cause a malfunction or damage the unit.

DC input	nom.	DC 110-300V	
DC input range	min.	88-360Vdc	
	min.	88-100Vdc	short term or with output derating (1%/V) or with reduced ambient temperature, see also Fig. 15-1, no damage between 0 and 88Vdc
	min.	360-425Vdc	short term, < 500ms
Allowed voltage between input to earth (ground)	max.	360Vdc	continuous, IEC 62103
		± 600V	peak value, allowed for transients
Slew rate for voltage between input to earth (ground)	max.	1000V/μs	
Allowed input ripple voltage	max.	50Vpp	50Hz – 10kHz
		15Vpp	10kHz – 50kHz
Turn-on voltage	typ.	85Vdc	steady-state value, see Fig. 4-1
Shut-down voltage	typ.	37Vdc	steady-state value at 2.5A load, see Fig. 4-1
	typ.	50Vdc	steady-state value at 5A load, see Fig. 4-1
	typ.	69Vdc	steady-state value at 10A load, see Fig. 4-1

		DC 110V	DC 300V	
Input current	typ.	4.68A	1.69A	at 48V, 10A, see Fig. 4-3
Start-up delay	typ.	1100ms	830ms	see Fig. 4-2
Rise time	typ.	90ms	90ms	at 48V, 10A const. current load, 0mF load capacitance, see Fig. 4-2
	typ.	230ms	230ms	at 48V, 10A const. current load, 10mF load capacitance, see Fig. 4-2
Turn-on overshoot	max.	200mV	200mV	see Fig. 4-2

Fig. 4-1 Input voltage range

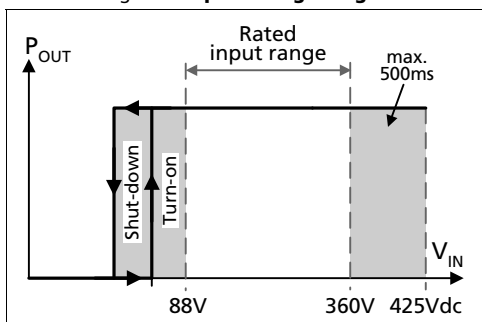

Fig. 4-2 Turn-on behavior, definitions

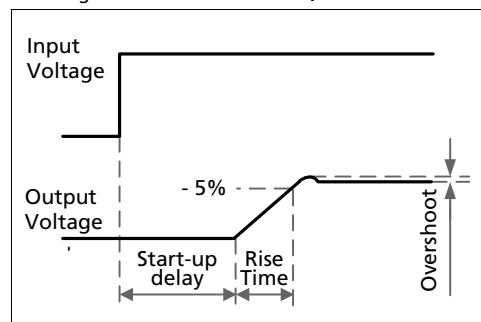
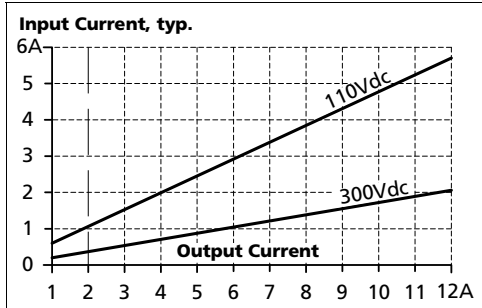

Fig. 4-3 **Input current vs. output load at 48V**



## 5. INPUT INRUSH CURRENT

An active inrush limitation circuit limits the input inrush current after turn-on of the input voltage and after short input voltage interruptions.

The charging current into EMI suppression capacitors is disregarded in the first microseconds after switch-on.

		DC 110V	DC 300V	
Inrush current <sup>*)</sup>	max.	13A <sub>peak</sub>	10A <sub>peak</sub>	temperature independent
	typ.	6A <sub>peak</sub>	4A <sub>peak</sub>	temperature independent
Inrush energy <sup>*)</sup>	max.	1A <sup>2</sup> s	1A <sup>2</sup> s	temperature independent
Inrush delay	typ.	1190ms	920ms	start-up delay plus rise time

\*) Mains interruptions > 500ms

Fig. 5-1 **Typical input inrush current behaviour at nominal load and 25°C ambient**

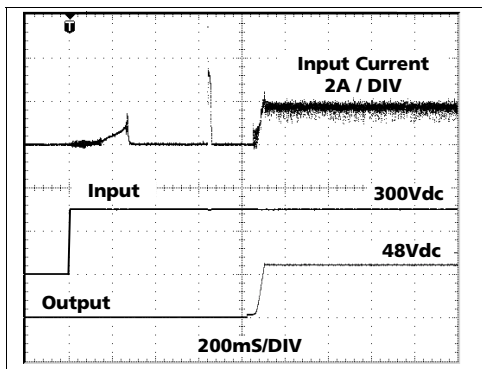

### 6. OUTPUT

Output voltage	nom.	48V	
Adjustment range	min.	48-56V	guaranteed
	max.	60V****)	at clockwise end position of potentiometer
Factory settings	typ.	48.0V	±0.2%, at full load, cold unit, in "single use" mode
	typ.	46.0V	±0.2%, at full load, cold unit, in "parallel use" mode
	typ.	48.0V	at no load, cold unit, in "parallel use" mode
Line regulation	max.	10mV	88-370Vdc
Load regulation	max.	150mV	in "single use" mode: static value, 0A → 10A; see Fig. 6-1
	typ.	2000mV	in "parallel use" mode: static value, 0A → 10A, see Fig. 6-2
Ripple and noise voltage	max.	50mVpp	20Hz to 20MHz, 50Ohm
Output current	nom.	10A	at 48V, ambient temperature <60°C, see Fig. 6-1
	nom.	12A*)	at 48V, ambient temperature <45°C, see Fig. 6-1
	nom.	8.6A	at 56V, ambient temperature <60°C, see Fig. 6-1
	nom.	10.3A*)	at 56V, ambient temperature <45°C, see Fig. 6-1
	typ.	40A	up to 15ms, output voltage stays above 40V, see Fig. 6-4. This peak current is available once every five seconds. See chapter 22.1 for more peak current measurements.
Output power	nom.	480W	continuously available
	nom.	576W*)	Power Boost@*)
Overload behaviour		cont. current	output voltage >25Vdc, see Fig. 6-1
		Hiccup <sup>PLUS</sup> mode**)	output voltage <25Vdc, see Fig. 6-1
Short-circuit current	min.	18A***)	load impedance <10mOhm, see Fig. 6-3
	max.	22A***)	load impedance <10mOhm, see Fig. 6-3
	max.	7A***)	average (R.M.S.) current, load impedance 100mOhm, see Fig. 6-3
	min.	40A	up to 15ms, load impedance <10mOhm, see Fig. 6-4
	typ.	50A	up to 15ms, load impedance <10mOhm, see Fig. 6-4
Output capacitance	typ.	2 450µF	included inside the DC/DC converter

- \*) **Power Boost**  
This power/ current is continuously allowed up to an ambient temperature of 45°C. Above 45°C, do not use this power/ current longer than a duty cycle of 10% and/ or not longer than 1 minute every 10 minutes.
- \*\*\*) **Hiccup<sup>PLUS</sup> Mode**  
At heavy overloads (when output voltage falls below 13V), the DC/DC converter delivers continuous output current for 2s. After this, the output is switched off for approx. 18s before a new start attempt is automatically performed. This cycle is repeated as long as the overload exists. If the overload has been cleared, the device will operate normally. See Fig. 6-3.
- \*\*\*)) Discharge current of output capacitors is not included.
- \*\*\*\*)) This is the maximum output voltage which can occur at the clockwise end position of the potentiometer due to tolerances. It is not guaranteed value which can be achieved. The typical value is about 57.0V (in "single use" mode).

Fig. 6-1 **Output voltage vs. output current, typ.**

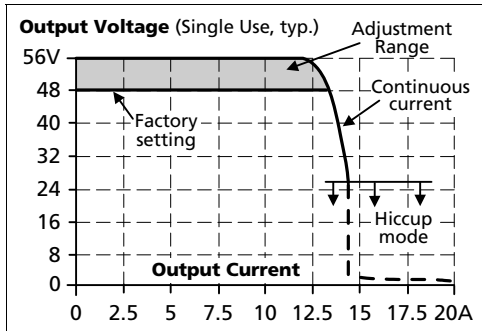

Fig. 6-2 **Output voltage in "parallel use" mode, typ.**

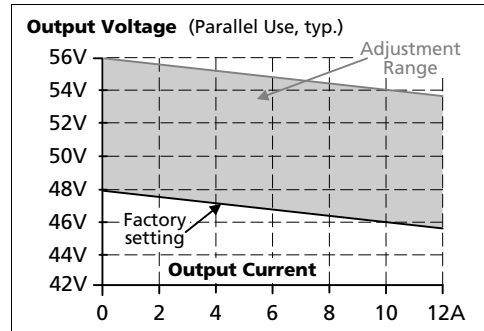

Fig. 6-3 **Short-circuit on output, Hiccup<sup>PLUS</sup> mode, typ.**

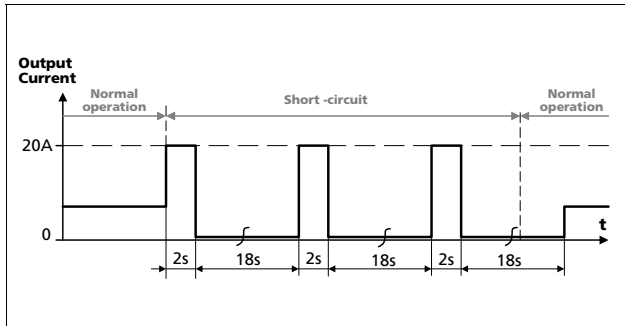
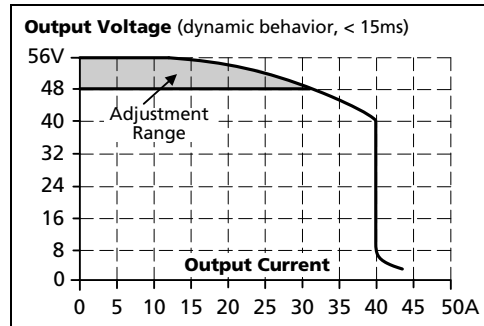

Fig. 6-4 **Dynamic overcurrent capability, typ.**



### 7. HOLD-UP TIME

The internal capacitor, which supplies the energy for the hold-up time is isolated by a diode to the input voltage. A short on the input line does not discharge the internal hold-up capacitor.

		DC 110V	DC 300V	
Hold-up Time	typ.	65ms	65ms	at 48V, 5A, see Fig. 7-1
	min.	54ms	54ms	at 48V, 5A, see Fig. 7-1
	typ.	26ms	26ms	at 48V, 10A, see Fig. 7-1
	min.	21ms	21ms	at 48V, 10A, see Fig. 7-1

Fig. 7-1 Hold-up time vs. input voltage

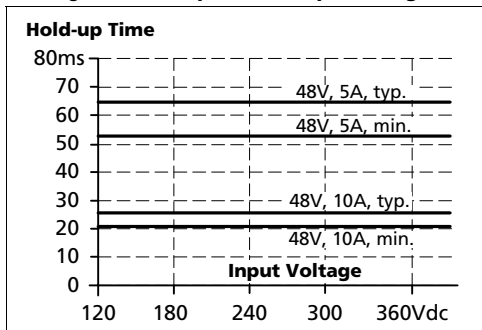
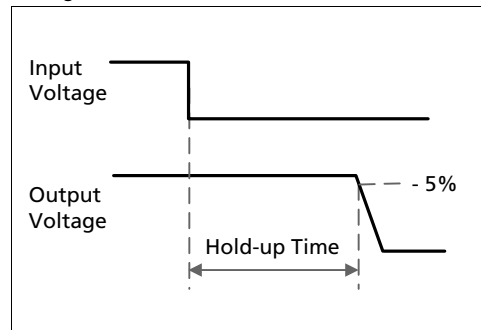

Fig. 7-2 Shut-down behavior, definitions



### 8. DC-OK RELAY CONTACT

This feature monitors the output voltage, which is produced by the DC/DC converter itself. It is independent of a backed voltage from a unit connected in parallel to the DC/DC converter output.

Contact closes	As soon as the output voltage reaches 90% of the adjusted output voltage level.		
Contact opens	As soon as the output voltage dips more than 10% below the adjusted output voltage. Short dips will be extended to a signal length of 100ms. Dips shorter than 1ms will be ignored.		
Contact ratings	max.	60Vdc 0.3A, 30Vdc 1A, 30Vac 0.5A	resistive load
	min.	1mA at 5Vdc	min. permissible load
Isolation voltage	See dielectric strength table in section 18.		

Fig. 8-1 DC-ok relay contact behavior

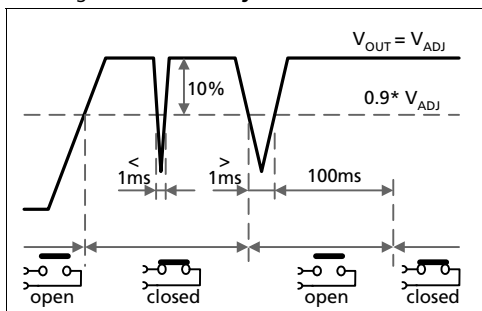



### 9. EFFICIENCY AND POWER LOSSES

		DC 110V	DC 300V	
Efficiency	typ.	93.1%	94.6%	at 48V, 10A
	typ.	93.1%	94.5%	at 48V, 12A (Power Boost)
Average efficiency*)	typ.	92.1%	93.3%	25% at 2.5A, 25% at 5A, 25% at 7.5A. 25% at 10A
Power losses	typ.	7.4W	2.5W	at 48V, 0A
	typ.	20.0W	15.9W	at 48V, 5A
	typ.	35.6W	27.4W	at 48V, 10A
	typ.	42.7W	33.5W	at 48V, 12A (Power Boost)

\*) The average efficiency is an assumption for a typical application where the DC/DC converter is loaded with 25% of the nominal load for 25% of the time, 50% of the nominal load for another 25% of the time, 75% of the nominal load for another 25% of the time and with 100% of the nominal load for the rest of the time.

Fig. 9-1 Efficiency vs. output current at 48V, typ

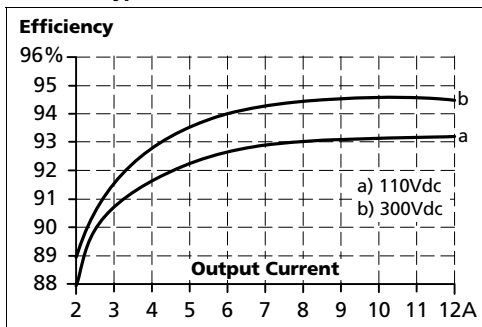

Fig. 9-2 Losses vs. output current at 48V, typ.

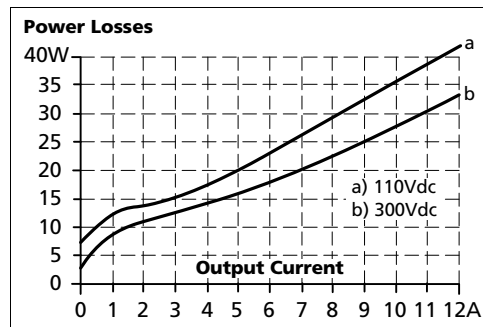

Fig. 9-3 Efficiency vs. input voltage at 48V, 10A, typ.

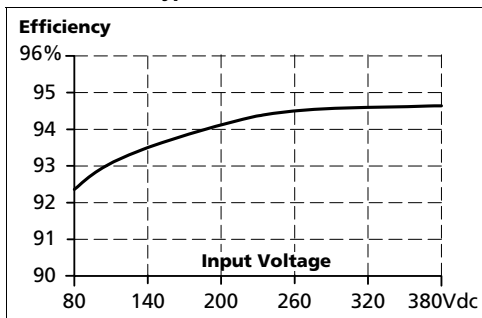
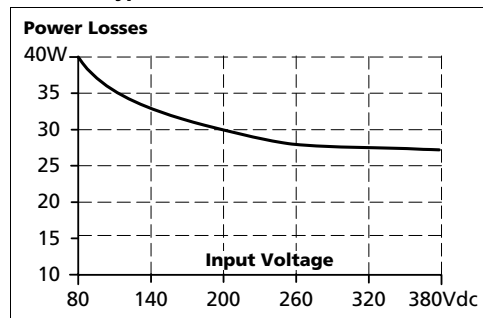

Fig. 9-4 Losses vs. input voltage at 48V, 10A, typ.



### 10. LIFETIME EXPECTANCY AND MTBF

	DC 110V	DC 300V	
Lifetime expectancy*)	156 000h*)	179 000h*)	at 48V, 5A and 40°C
	440 000h*)	506 000h*)	at 48V, 5A and 25°C
	85 000h	110 000h	at 48V, 10A and 40°C
	241 000h*)	313 000h*)	at 48V, 10A and 25°C
	58 000h	76 000h	at 48V, 12A and 40°C
MTBF**) SN 29500, IEC 61709	164 000h*)	214 000h*)	at 48V, 12A and 25°C
	468 000h	537 000h	at 48V, 10A and 40°C
MTBF**) MIL HDBK 217F	770 000h	882 000h	at 48V, 10A and 25°C
	254 000h	290 000h	at 48V, 10A and 40°C; Ground Benign GB40
	355 000h	395 000h	at 48V, 10A and 25°C; Ground Benign GB25
	56 000h	64 000h	at 48V, 10A and 40°C; Ground Fixed GF40
	75 000h	86 000h	at 48V, 10A and 25°C; Ground Fixed GF25

\*) The **Lifetime expectancy** shown in the table indicates the minimum operating hours (service life) and is determined by the lifetime expectancy of the built-in electrolytic capacitors. Lifetime expectancy is specified in operational hours and is calculated according to the capacitor's manufacturer specification. The manufacturer of the electrolytic capacitors only guarantees a maximum life of up to 15 years (131 400h). Any number exceeding this value is a calculated theoretical lifetime which can be used to compare devices.

\*\*) **MTBF** stands for **Mean Time Between Failure**, which is calculated according to statistical device failures, and indicates reliability of a device. It is the statistical representation of the likelihood of a unit to fail and does not necessarily represent the life of a product. The MTBF figure is a statistical representation of the likelihood of a device to fail. A MTBF figure of e.g. 1 000 000h means that statistically one unit will fail every 100 hours if 10 000 units are installed in the field. However, it can not be determined if the failed unit has been running for 50 000h or only for 100h.

### 11. FUNCTIONAL DIAGRAM

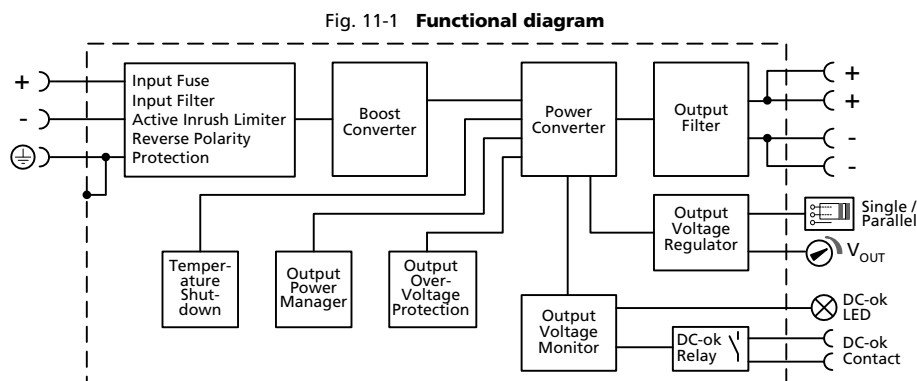

## 12. TERMINALS AND WIRING

The terminals are IP20 Finger safe constructed and suitable for field- and factory wiring.

	Input and output	DC-OK-Signal
<b>Type</b>	screw terminals	spring-clamp terminals
Solid wire	0.5-6mm <sup>2</sup>	0.15-1.5mm <sup>2</sup>
Stranded wire	0.5-4mm <sup>2</sup>	0.15-1.5mm <sup>2</sup>
American Wire Gauge	AWG20-10	AWG26-14
Max. wire diameter	2.8mm (including ferrules)	1.5mm (including ferrules)
Wire stripping length	7mm / 0.28inch	7mm / 0.28inch
Screwdriver	3.5mm slotted or cross-head No 2	3.5mm slotted (to open the spring)
Recommended tightening torque	1Nm, 9lb.in	not applicable

### Instructions:

- Use appropriate copper cables that are designed for minimum operating temperatures of:  
60°C for ambient up to 45°C and  
75°C for ambient up to 60°C minimum  
90°C for ambient up to 70°C minimum.
- Follow national installation codes and installation regulations!
- Ensure that all strands of a stranded wire enter the terminal connection!
- Do not use the unit without PE connection.
- Unused terminal compartments should be securely tightened.
- Ferrules are allowed.

### Daisy chaining:

Daisy chaining (jumping from one DC/DC converter output to the next) is allowed as long as the average output current through one terminal pin does not exceed 25A. If the current is higher, use a separate distribution terminal block as shown in Fig. 12-2.

Fig. 12-1 Daisy chaining of outputs

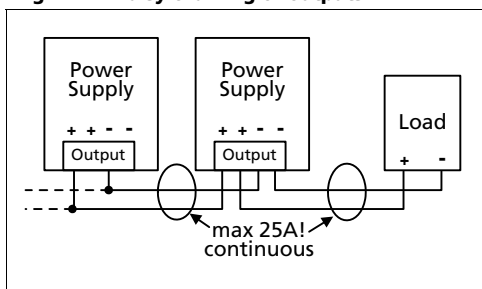
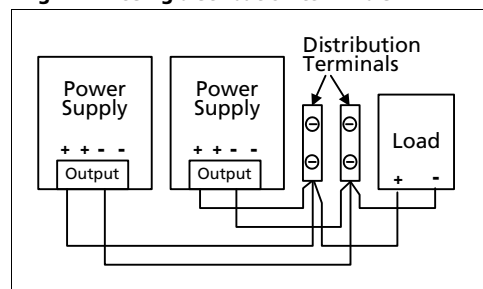
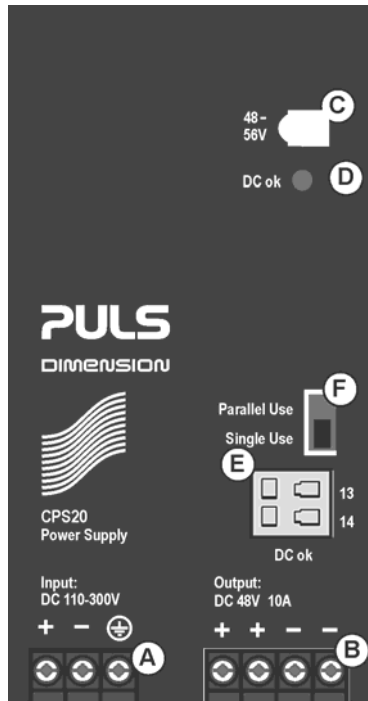

Fig. 12-2 Using distribution terminals



### 13. FRONT SIDE AND USER ELEMENTS

Fig. 13-1 Front side



**A Input Terminals** (screw terminals)

- + Positive input
- Negative (return) input
- ⊕ PE (Protective Earth) input

**B Output Terminals** (screw terminals, two pins per pole)

- + Positive output
- Negative (return) output

**C Output voltage potentiometer**

Open the flap to adjust the output voltage. Factory set: 48.0V

**D DC-OK LED** (green)

On, when the output voltage is >90% of the adjusted output voltage

**E DC-OK Relay Contact** (quick-connect spring-clamp terminals)

The DC-OK relay contact is synchronized with the DC-OK LED. See chapter 8 for details.

**F "Parallel Use" "Single Use" selector**

Set jumper to "Parallel Use" when DC/DC converter are connected in parallel to increase the output power. In order to achieve a sharing of the load current between the individual DC/DC converter, the "parallel use" regulates the output voltage in such a manner that the voltage at no load is approx. 4% higher than at nominal load. See also chapter 22.5. A missing jumper is equal to a "Single Use" mode.

### 14. EMC

The DC/DC converter is suitable for applications in industrial environment as well as in residential, commercial and light industry environment without any restrictions. A detailed EMC report is available on request.

<b>EMC Immunity</b>		According generic standards: EN 61000-6-1 and EN 61000-6-2		
Electrostatic discharge	EN 61000-4-2	contact discharge air discharge	8kV 15kV	Criterion A Criterion A
Electromagnetic RF field	EN 61000-4-3	80MHz-2.7GHz	20V/m	Criterion A
Fast transients (Burst)	EN 61000-4-4	input lines output lines DC-OK signal (coupling clamp)	4kV 2kV 2kV	Criterion A Criterion A Criterion A
Surge voltage on input	EN 61000-4-5	+ → - + → PE, - → PE	2kV 4kV	Criterion A Criterion A
Surge voltage on output	EN 61000-4-5	+ → - + / - → PE	1kV 2kV	Criterion A Criterion A
Surge voltage on DC-OK	EN 61000-4-5	DC-OK signal → PE	1kV	Criterion A
Conducted disturbance	EN 61000-4-6	0.15-80MHz	20V	Criterion A

**Criteria:**

- A:** DC/DC converter shows normal operation behavior within the defined limits.
- C:** Temporary loss of function is possible. DC/DC converter may shut-down and restarts by itself. No damage or hazards for the DC/DC converter will occur.

<b>EMC Emission</b>		According generic standards: EN 61000-6-3 and EN 61000-6-4	
Conducted emission input lines	CISPR 16-1-2, CISPR 16-2-1		limits for DC power port according EN 61000-6-3 fulfilled
Conducted emission output lines*)	CISPR 16-1-2, CISPR 16-2-1		limits for DC power port according EN 61000-6-3 fulfilled
Radiated emission	EN 55011, EN 55022		Class B

This device complies with FCC Part 15 rules.

Operation is subjected to following two conditions: (1) this device may not cause harmful interference, and (2) this device must accept any interference received, including interference that may cause undesired operation.

\*) for information only, not mandatory for EN 61000-6-3

<b>Switching Frequencies</b>		The DC/DC converter has two converters with two different switching frequencies included.	
Switching frequency 1	70kHz to 130kHz	PFC converter, input voltage and output power dependent	
Switching frequency 2	80kHz to 140kHz	Main converter, output power dependent	

### 15. ENVIRONMENT

Operational temperature <sup>*)</sup>	-25°C to +70°C (-13°F to 158°F)	reduce output power according Fig. 15-1
Storage temperature	-40 to +85°C (-40°F to 185°F)	for storage and transportation
Output de-rating	6.4W/°C 12W/°C	45°C to 60°C (113°F to 140°F) 60°C to 70°C (140°F to 158°F)
Humidity <sup>**)</sup>	5 to 95% r.h.	IEC 60068-2-30
Vibration sinusoidal	2-17.8Hz: ±1.6mm; 17.8-500Hz: 2g <sup>***)</sup> 2 hours / axis	IEC 60068-2-6
Shock	30g 6ms, 20g 11ms <sup>***)</sup> 3 bumps / direction, 18 bumps in total	IEC 60068-2-27
Altitude	0 to 2000m (0 to 6 560ft) 2000 to 6000m (6 560 to 20 000ft)	without any restrictions reduce output power or ambient temperature, see Fig. 15-2 IEC 62103, EN 50178, overvoltage category II
Altitude de-rating	30W/1000m or 5°C/1000m	> 2000m (6500ft), see Fig. 15-2
Over-voltage category	III II	IEC 62103, EN 50178, altitudes up to 2000m altitudes from 2000m to 6000m
Degree of pollution	2	IEC 62103, EN 50178, not conductive
LABS compatibility	The unit does not release any silicone or other LABS-critical substances and is suitable for use in paint shops.	
Audible noise	At load currents below 1A some audible noise will be emitted from the DC/DC converter	

\*) Operational temperature is the same as the ambient temperature and is defined as the air temperature 2cm below the unit.  
 \*\*) Do not energize while condensation is present  
 \*\*\*) Tested in combination with DIN-Rails according to EN 60715 with a height of 15mm and a thickness of 1.3mm and standard orientation. Higher levels allowed when using the wall mounting bracket ZM2.WALL

Fig. 15-1 Output current vs. ambient temp.

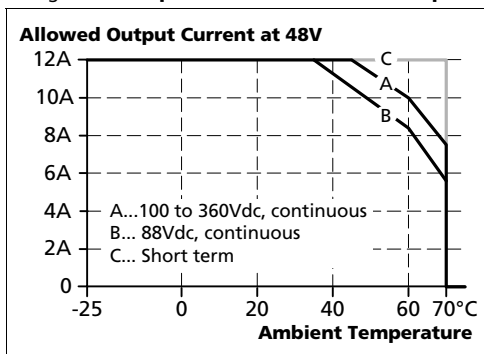
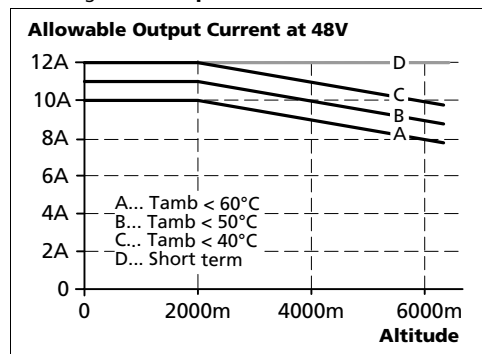

Fig. 15-2 Output current vs. altitude



### 16. PROTECTION FEATURES

Output protection	Electronically protected against overload, no-load and short-circuits <sup>*)</sup>	
Output over-voltage protection	typ. 58.5Vdc max. 60Vdc	In case of an internal DC/DC converter defect, a redundant circuit limits the maximum output voltage. The output shuts down and automatically attempts to restart.
Degree of protection	IP 20	EN/IEC 60529 Caution: For use in a controlled environment according to CSA 22.2 No 107.1-01.
Penetration protection	> 5mm	e.g. screws, small parts
Over-temperature protection	yes	Output shut-down with automatic restart
Input transient protection	MOV (Metal Oxide Varistor)	
Internal input fuse	DC suitable fuse included	not user replaceable
Reverse input polarity protection	yes	unit does not start, no signalling

<sup>\*)</sup> In case of a protection event, audible noise may occur.

### 17. SAFETY FEATURES

Input / output separation <sup>*)</sup>	SELV PELV double or reinforced insulation	IEC/EN 60950-1 IEC/EN 60204-1, EN 50178, IEC 62103, IEC 60364-4-41
Class of protection	I	PE (Protective Earth) connection required
Isolation resistance	> 5MΩ	input to output, 500Vdc
PE resistance	< 0.1Ω	
Touch current (leakage current)	The leakage current which is produced by the DC/DC converter itself depends on the input voltage ripple and need to be investigated in the final application. For a smooth DC input voltage, the produced leakage current is less than 100µA.	

<sup>\*)</sup> double or reinforced insulation

### 18. DIELECTRIC STRENGTH

The output voltage is floating and has no ohmic connection to the ground. Type and factory tests are conducted by the manufacturer. Field tests may be conducted in the field using the appropriate test equipment which applies the voltage with a slow ramp (2s up and 2s down). Connect all input-terminals together as well as all output poles before conducting the test. When testing, set the cut-off current settings to the value in the table below.

Fig. 18-1 Dielectric strength

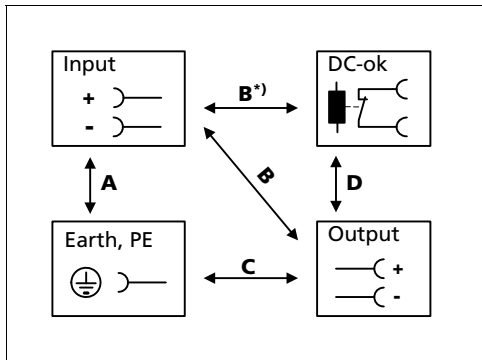





B\*) When testing input to DC-OK ensure that the max. voltage between DC-OK and the output is not exceeded (column D). We recommend connecting DC-OK pins and the output pins together when performing the test.

		A	B	C	D
Type test	60s	2500Vac	3000Vac	1000Vac	500Vac
Factory test	5s	2500Vac	2500Vac	500Vac	500Vac
Field test	5s	2000Vac	2000Vac	500Vac	500Vac
Cut-off current setting		> 15mA	> 15mA	> 20mA	> 1mA

To fulfil the PELV requirements according to EN60204-1 § 6.4.1, we recommend that either the + pole, the - pole or any other part of the output circuit shall be connected to the protective earth system. This helps to avoid situations in which a load starts unexpectedly or can not be switched off when unnoticed earth faults occur.



### 19. APPROVALS

EC Declaration of Conformity		The CE mark indicates conformance with the - EMC directive 2004/108/EC, - Low-voltage directive (LVD) 2006/95/EC, - RoHS directive 2011/65/EU and the - ATEX directive 94/9/EC (for use in explosive atmospheres)
IEC 60950-1 2 <sup>nd</sup> Edition		CB Scheme, Information Technology Equipment
UL 508		Listed for use as Industrial Control Equipment; U.S.A. (UL 508) and Canada (C22.2 No. 107-1-01); E-File: E198865
UL 60950-1 2 <sup>nd</sup> Edition		Recognized for use as Information Technology Equipment, Level 5; U.S.A. (UL 60950-1) and Canada (C22.2 No. 60950-1); E-File: E137006 Applicable for altitudes up to 2000m.
ANSI / ISA 12.12.01-2007 Class I Div 2		Recognized for use in Hazardous Location Class I Div 2 T3 Groups A,B,C,D systems; U.S.A. (ANSI / ISA 12.12.01-2007) and Canada (C22.2 No. 213-M1987)
EN 60079-0, EN 60079-15 ATEX	 II 3G Ex nA nC II T3 Gc	Approval for use in hazardous locations Zone 2 Category 3G. Number of ATEX certificate: EPS 13 ATEX 1 555 X The DC/DC converter must be built-in in an IP54 enclosure.
IEC 60079-0, IEC 60079-15		Suitable for use in Class 1 Zone 2 Groups IIa, IIb and IIc locations. Number of IECEx certificate: IECEx EPS 13.0016X
GOST R		Certificate of Conformity for Russia and other GUS countries

### 20. PHYSICAL DIMENSIONS AND WEIGHT

Weight	940g / 2.1lb
DIN-Rail	Use 35mm DIN-rails according to EN 60715 or EN 50022 with a height of 7.5 or 15mm. The DIN-rail height must be added to the unit depth (127mm) to calculate the total required installation depth.
Installation Clearances	See chapter 2

Fig. 20-1 **Front view**

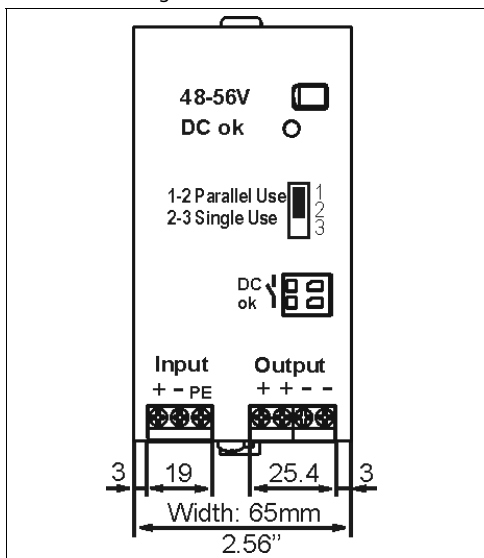
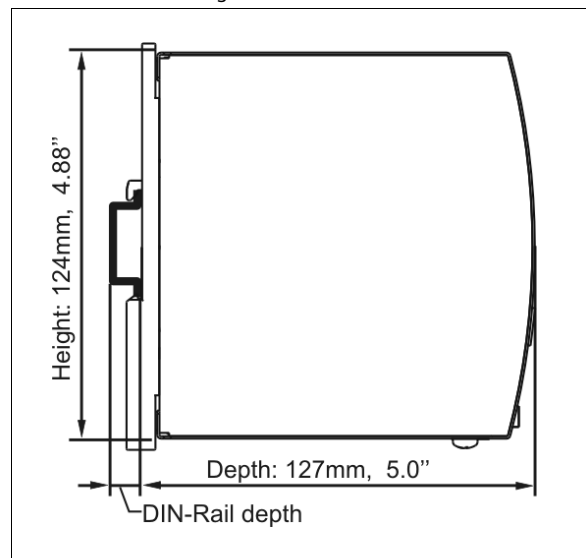

Fig. 20-2 **Side view**



## 21. ACCESSORIES

### 21.1. ZM2.WALL - WALL MOUNTING BRACKET

This bracket is used to mount the DC/DC converter onto a flat surface without utilizing a DIN-Rail.

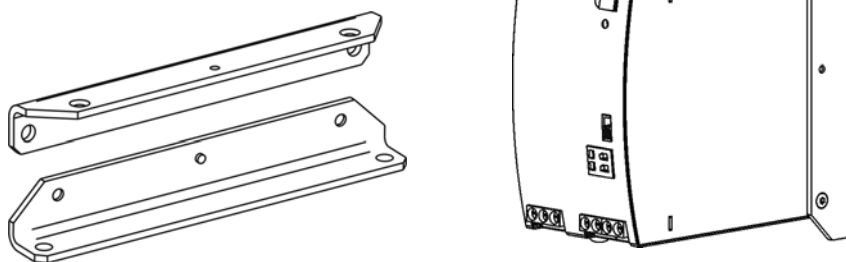

### 21.2. ZM13.SIDE - SIDE MOUNTING BRACKET

This bracket is used to mount DIMENSION units sideways with or without utilizing a DIN-Rail. The two aluminum brackets and the black plastic slider of the unit have to be detached, so that the steel brackets can be mounted.

For sideways DIN-rail mounting, the removed aluminum brackets and the black plastic slider need to be mounted on the steel bracket.

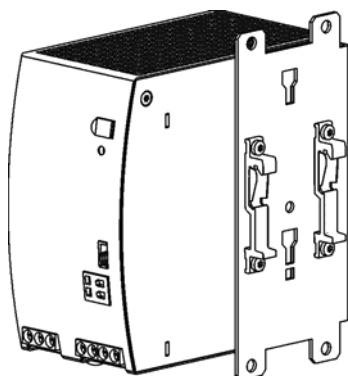

Side mounting with DIN-rail brackets

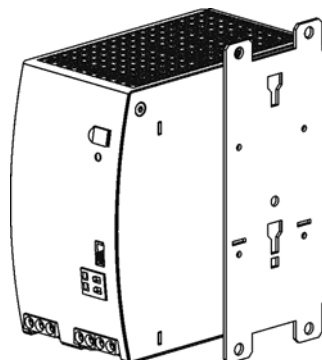

Side mounting without DIN-rail brackets

### 21.3. REDUNDANCY MODULES

#### YR40.482 – (2x 20A Inputs, 1x 40A output)



The YR40.482 is equipped with two input channels, which are individually decoupled by utilizing mosfet technology. Using mosfets instead of diodes reduces the heat generation and the voltage drop between input and output. The YR40.482 does not require an additional auxiliary voltage and is self-powered even in case of a short circuit across the output.

Due to the low power losses, the unit is very slender and only requires 46mm width on the DIN-rail.

Fig. 21-1 **Typical 1+1 Redundant configuration for 48V, 10A with a dual redundancy module**

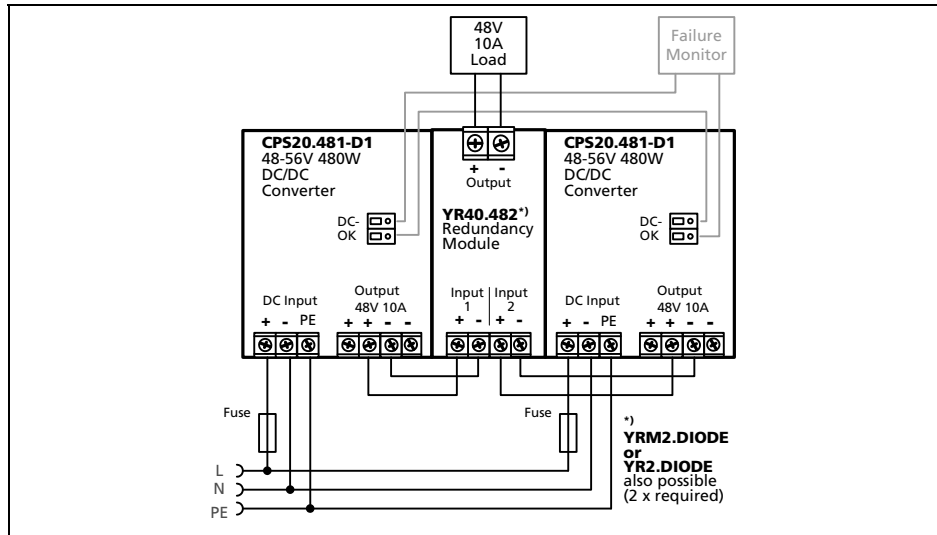

## 22. APPLICATION NOTES

### 22.1. PEAK CURRENT CAPABILITY

The DC/DC converter can deliver peak currents (up to several milliseconds) which are higher than the specified short term currents.

This helps to start current demanding loads. Solenoids, contactors and pneumatic modules often have a steady state coil and a pick-up coil. The inrush current demand of the pick-up coil is several times higher than the steady-state current and usually exceeds the nominal output current (including the PowerBoost). The same situation applies when starting a capacitive load.

The peak current capability also ensures the safe operation of subsequent circuit breakers of load circuits. The load branches are often individually protected with circuit breakers or fuses. In case of a short or an overload in one branch circuit, the fuse or circuit breaker need a certain amount of over-current to open in a timely manner. This avoids voltage loss in adjacent circuits.

The extra current (peak current) is supplied by the power converter and the built-in large sized output capacitors of the DC/DC converter. The capacitors get discharged during such an event, which causes a voltage dip on the output. The following two examples show typical voltage dips:

Fig. 22-1 **Peak load with 2x the nominal current for 50ms, typ.**

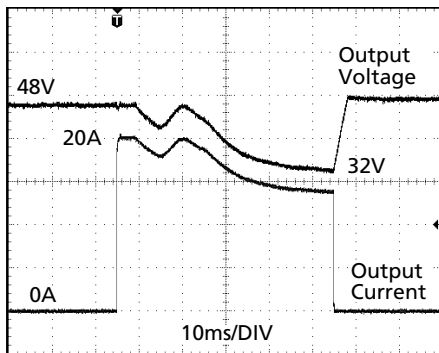

Peak load 20A (resistive) for 50ms  
Output voltage dips from 48V to 32V.

Fig. 22-2 **Peak load with 5x the nominal current for 5ms, typ.**

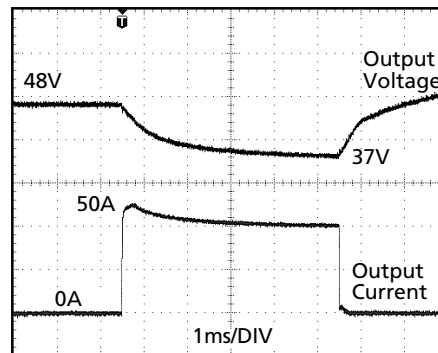

Peak load 50A (resistive) for 5ms  
Output voltage dips from 48V to 37V.

Please note: The DC-OK relay triggers when the voltage dips more than 10% for longer than 1ms.

Peak current voltage dips	typ.	from 48V to 32V	at 20A for 50ms, resistive load
	typ.	from 48V to 39V	at 50A for 2ms, resistive load
	typ.	from 48V to 37V	at 50A for 5ms, resistive load

### 22.2. BACK-FEEDING LOADS

Loads such as decelerating motors and inductors can feed voltage back to the DC/DC converter. This feature is also called return voltage immunity or resistance against Back- E.M.F. (Electro Magnetic Force).

This DC/DC converter is resistant and does not show malfunctioning when a load feeds back voltage to the DC/DC converter. It does not matter whether the DC/DC converter is on or off.

The maximum allowed feed-back-voltage is 63Vdc. The absorbing energy can be calculated according to the built-in large sized output capacitor which is specified in chapter 6.

### 22.3. EXTERNAL INPUT PROTECTION

The unit is tested and approved for branch circuits up to 30A (UL) and 32A (IEC). An external protection is only required if the supplying branch has an ampacity greater than this. Provided, that the negative pole is grounded. If the positive pole is grounded, an additional external fast-acting input fuse in the negative input is required (E.g. 8A KLKD fuse from Littelfuse or a comparable UL-Listed fuse with the same ratings and characteristics). Otherwise the status of the UL approvals becomes void.

Check also local codes and local requirements. In some countries local regulations might apply.

If an external fuse is necessary or utilized, minimum requirements need to be considered to avoid nuisance tripping of the circuit breaker. A minimum value of 10A B- or C-Characteristic breaker should be used.

### 22.4. OUTPUT CIRCUIT BREAKERS

Standard miniature circuit breakers (MCB's or UL1077 circuit breakers) are commonly used for AC-supply systems and may also be used on 48V branches.

MCB's are designed to protect wires and circuits. If the ampere value and the characteristics of the MCB are adapted to the wire size that is used, the wiring is considered as thermally safe regardless of whether the MCB opens or not.

To avoid voltage dips and under-voltage situations in adjacent 48V branches which are supplied by the same source, a fast (magnetic) tripping of the MCB is desired. A quick shutdown within 10ms is necessary corresponding roughly to the ride-through time of PLC's. This requires DC/DC converters with high current reserves and large output capacitors. Furthermore, the impedance of the faulty branch must be sufficiently small in order for the current to actually flow. The best current reserve in the DC/DC converter does not help if Ohm's law does not permit current flow. The following table has typical test results showing which B- and C-Characteristic MCBs magnetically trip depending on the wire cross section and wire length.

Fig. 22-3 Test circuit

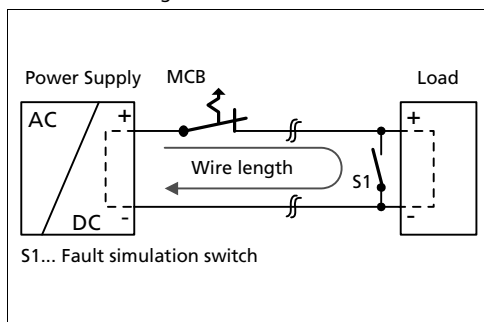

Maximal wire length<sup>\*)</sup> for a fast (magnetic) tripping:

	0.75mm <sup>2</sup>	1.0mm <sup>2</sup>	1.5mm <sup>2</sup>	2.5mm <sup>2</sup>
<b>C-2A</b>	74m	98m	134m	198m
<b>C-3A</b>	57m	74m	106m	168m
<b>C-4A</b>	43m	56m	73m	114m
<b>C-6A</b>	11m	16m	23m	33m
<b>C-8A</b>	1m	1m	2m	3m
<b>B-6A</b>	19m	36m	51m	82m
<b>B-10A</b>	9m	12m	18m	27m
<b>B-13A</b>	7m	10m	16m	24m

\*) Don't forget to consider twice the distance to the load (or cable length) when calculating the total wire length (+ and - wire).

### 22.5. PARALLEL USE TO INCREASE OUTPUT POWER

CPS20.481-D1 DC/DC converter can be paralleled to increase the output power. The output voltage of all DC/DC converters shall be adjusted to the same value ( $\pm 100\text{mV}$ ) in "Single use" mode with the same load conditions on all units, or the units can be left with the factory settings. After the adjustments, the jumper on the front of the unit shall be moved from "Single use" to "Parallel use", in order to achieve load sharing. The "Parallel use" mode regulates the output voltage in such a manner that the voltage at no load is approx. 4% higher than at nominal load. See also chapter 6. If no jumper is plugged in, the unit is in "Single use" mode. Factory setting is "Single use" mode.

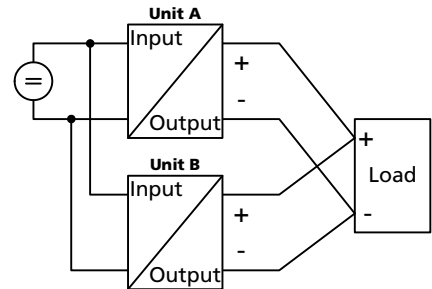

If more than three units are connected in parallel, a fuse or circuit breaker with a rating of 15A or 16A is required on each output. Alternatively, a diode or redundancy module can also be utilized.

Energize all units at the same time to avoid the overload Hiccup<sup>PLUS</sup> mode. It also might be necessary to cycle the input power (turn-off for at least five seconds), if the output was in Hiccup<sup>PLUS</sup> mode due to overload or short circuits and the required output current is higher than the current of one unit.

Keep an installation clearance of 15mm (left / right) between two DC/DC converters and avoid installing the DC/DC converters on top of each other. Do not use DC/DC converters in parallel in mounting orientations other than the standard mounting orientation (terminals on bottom of the unit) or in any other condition where a derating of the output current is required (e.g. altitude, above 60°C, ...).

Pay attention that EMI and inrush current will increase when using multiple DC/DC converters.

### 22.6. PARALLEL USE FOR REDUNDANCY

DC/DC converters can be paralleled for redundancy to gain higher system availability. Redundant systems require a certain amount of extra power to support the load in case one DC/DC converter unit fails. The simplest way is to put two DC/DC converters in parallel. This is called a 1+1 redundancy. In case one DC/DC converter unit fails, the other one is automatically able to support the load current without any interruption. Redundant systems for a higher power demand are usually built in a N+1 method. E.g. five DC/DC converter, each rated for 10A are paralleled to build a 40A redundant system. For N+1 redundancy the same restrictions apply as for increasing the output power, see also chapter 22.5.

**Please note:** This simple way to build a redundant system does not cover failures such as an internal short circuit in the secondary side of the DC/DC converter. In such a case, the defective unit becomes a load for the other DC/DC converters and the output voltage can not be maintained any more. This can be avoided by utilizing redundancy modules, which have decoupling devices (diodes or mosfets) included. Further information and wiring configurations can be found in chapter 21.3.

Recommendations for building redundant power systems:

- Use separate input fuses for each DC/DC converter.
- Set the DC/DC converter into "Parallel use" mode.
- Monitor the individual DC/DC converter units. Therefore, use the DC-OK relay contact of the CPS20 DC/DC converter.
- It is desirable to set the output voltages of all units to the same value ( $\pm 100\text{mV}$ ) or leave it at the factory setting.

### 22.7. SERIES OPERATION

DC/DC converters of the same type can be connected in series for higher output voltages. It is possible to connect as many units in series as needed, providing the sum of the output voltage does not exceed 150Vdc. Voltages with a potential above 60Vdc are not SELV any more and can be dangerous. Such voltages must be installed with a protection against touching.

Earthing of the output is required when the sum of the output voltage is above 60Vdc.

Avoid return voltage (e.g. from a decelerating motor or battery) which is applied to the output terminals.

Keep an installation clearance of 15mm (left / right) between two DC/DC converters and avoid installing the DC/DC converters on top of each other. Do not use DC/DC converters in series in mounting orientations other than the standard mounting orientation (terminals on bottom of the unit).

Pay attention that EMI and inrush current will increase when using multiple DC/DC converters.

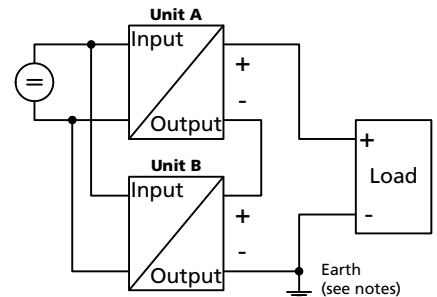

### 22.8. INDUCTIVE AND CAPACITIVE LOADS

The unit is designed to supply any kind of loads, including capacitive and inductive loads. If extreme large capacitors, such as EDLCs (electric double layer capacitors or "UltraCaps") with a capacitance > 0.15F are connected to the output, the unit might charge the capacitor in the Hiccup<sup>PLUS</sup> mode (see chapter 6).



## 22.9. CHARGING OF BATTERIES

The DC/DC converter can be used to charge lead-acid or maintenance free batteries. (Four 12V batteries in series)

### Instructions for charging batteries:

- a) Set output voltage (measured at no load and at the battery end of the cable) very precisely to the end-of-charge voltage.

End-of-charge voltage	55.6V	55.0V	54.3V	53.6V
Battery temperature	10°C	20°C	30°C	40°C

- b) Use a 15A or 16A circuit breaker (or blocking diode) between the DC/DC converter and the battery.  
c) Ensure that the output current of the DC/DC converter is below the allowed charging current of the battery.  
d) Use only matched batteries when putting 12V types in series.  
e) The return current to the DC/DC converter (battery discharge current) is typ. 7mA when the DC/DC converter is switched off (except in case a blocking diode is utilized).

## 22.10. USE IN A TIGHTLY SEALED ENCLOSURE

When the DC/DC converter is installed in a tightly sealed enclosure, the temperature inside the enclosure will be higher than outside. In such situations, the inside temperature defines the ambient temperature for the DC/DC converter.

The following measurement results can be used as a reference to estimate the temperature rise inside the enclosure.

The DC/DC converter is placed in the middle of the box, no other heat producing items are inside the box

Enclosure:	Rittal Typ IP66 Box PK 9522 100, plastic, 254x180x165mm
Load:	48V, 8A; (=80%) load is placed outside the box
Input:	300Vdc
Temperature inside enclosure:	50.3°C (in the middle of the right side of the DC/DC converter with a distance of 2cm)
Temperature outside enclosure:	24.2
Temperature rise:	25.8K

### 22.11. MOUNTING ORIENTATIONS

Mounting orientations other than all terminals on the bottom require a reduction in continuous output power or a limitation in the maximum allowed ambient temperature. The amount of reduction influences the lifetime expectancy of the DC/DC converter. Therefore, two different derating curves for continuous operation can be found below:

**Curve A1**

Recommended output current.

**Curve A2**

Max allowed output current (results in approximately half the lifetime expectancy of A1).

Fig. 22-4  
**Mounting Orientation A**  
(Standard orientation)

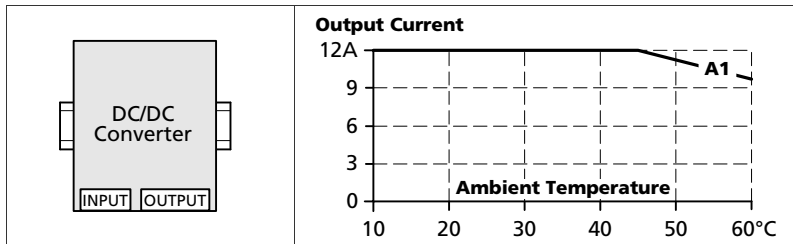

Fig. 22-5  
**Mounting Orientation B**  
(Upside down)

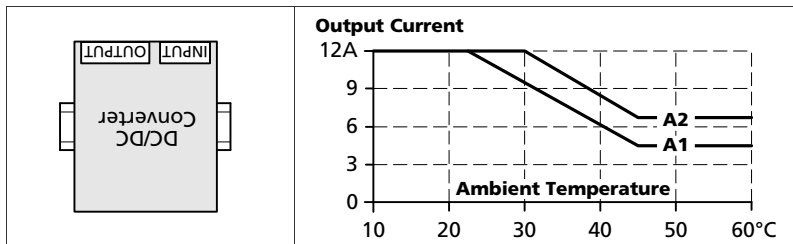

Fig. 22-6  
**Mounting Orientation C**  
(Table-top mounting)

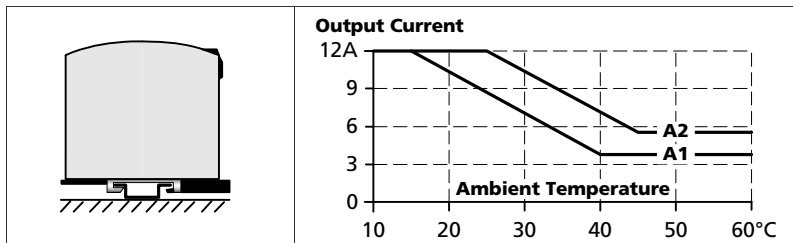

Fig. 22-7  
**Mounting Orientation D**  
(Horizontal cw)

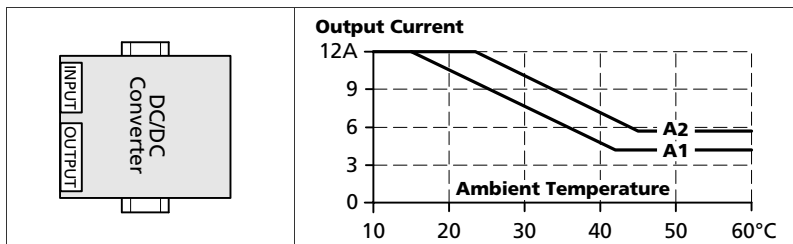

Fig. 22-8  
**Mounting Orientation E**  
(Horizontal ccw)

