

THIS COPY IS PROVIDED ON A RESTRICTED BASIS AND IS NOT TO BE USED IN ANY WAY DETRIMENTAL TO THE INTERESTS OF PANDUIT CORP.

TWIST TIE

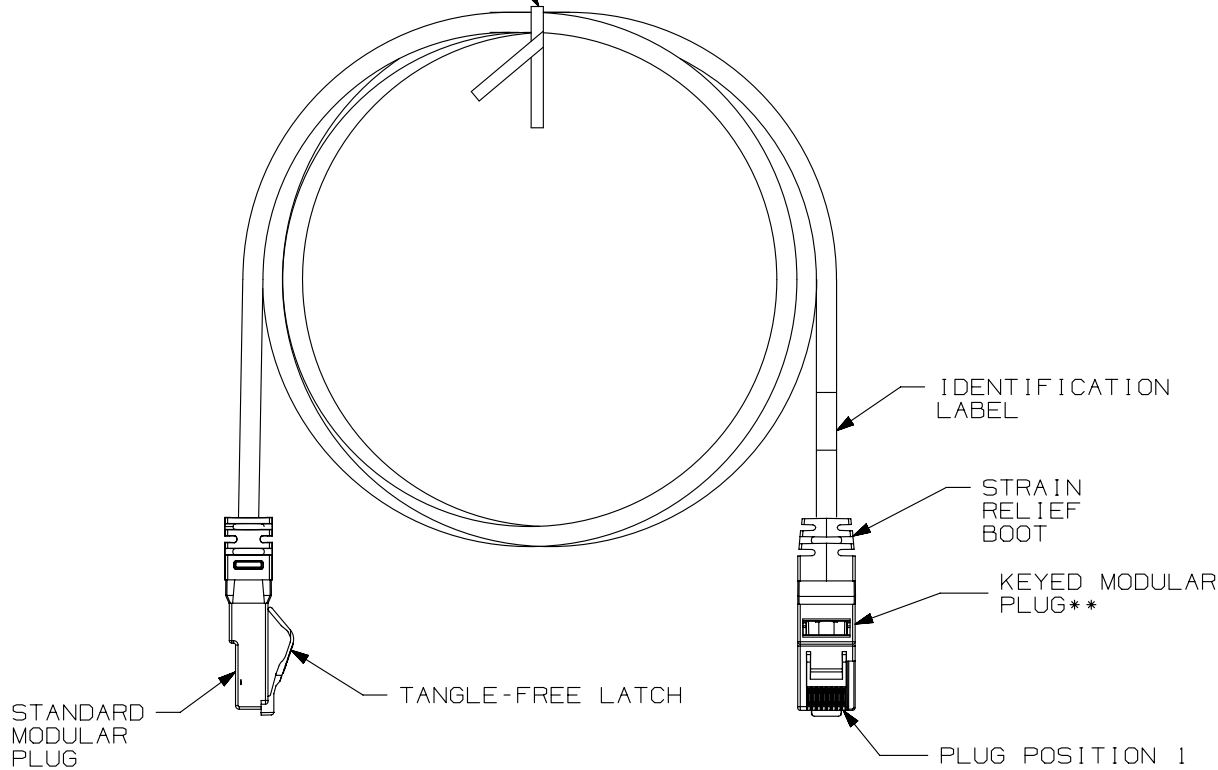

PANDUIT PART NUMBER	MIN. CABLE LENGTH	WEIGHT
UTPK6A3**	3 FT.	.095 LB/EACH (43.1 g/EACH)
UTPK6A5**	5 FT.	.150 LB/EACH (68.0 g/EACH)
UTPK6A7**	7 FT.	.205 LB/EACH (93.0 g/EACH)
UTPK6A10**	10 FT.	.260 LB/EACH (117.9 g/EACH)
UTPK6A14**	14 FT.	.395 LB/EACH (179.2 g/EACH)
UTPK6A1M**	1 METER	.103 LB/EACH (46.6 g/EACH)
UTPK6A2M**	2 METERS	.193 LB/EACH (87.4 g/EACH)
UTPK6A3M**	3 METERS	.283 LB/EACH (128.4 g/EACH)
UTPK6A5M**	5 METERS	.460 LB/EACH (209.0 g/EACH)
UTPK6A7M**	7 METERS	.751 LB/EACH (304.6 g/EACH)
UTPK6A10M**	10 METERS	1.073 LB/EACH (486.5 g/EACH)

\*\* P/N CODE FOR KEYED PLUG HOUSING COLOR, CABLE COLOR AND SPECIAL KEY CONFIGURATION. SEE SHEET 2 FOR DETAILS.

NOTES:

1. SEE CURRENT CATALOG FOR VARIOUS APPLICATIONS AND TO INDICATE COLOR AND OR PACKAGE QUANTITY.
2. SEE CATALOG FOR A COMPLETE LIST OF PARTS APPLICABLE FOR USE WITH THIS PART.

T568B WIRING SCHEME

PLUG POSITION:	CABLE WIRE:
1	WHITE/ORANGE
2	ORANGE
3	WHITE/GREEN
4	BLUE
5	WHITE/BLUE
6	GREEN
7	WHITE/BROWN
8	BROWN

PART NUMBER		UTPK6A***	
TITLE			
		TX6A 10GIG UTP KEYED PATCH CORDS	
CUSTOMER DRAWING			
ITEM REVISION NAME		M03011EN/00	
DATASET FILE NAME		M03011EN_DC66/00C	
UNLESS OTHERWISE SPECIFIED, DIMENSIONAL TOLERANCES ARE: IN (mm)		MATERIAL:	
.x ±		.xxx ± .010 (.3)	
.xx ± .03 (.8)		ANGLES ±	
DRAWN BY		THIRD ANGLE PROJECTION	
DATE		DRAWING NUMBER:	
12-10-08		03011-66	
CHK		SHT 1 OF 2	
PBD		A	
SCALE		NONE	
REV		SIZE	
4-4-14		A	

REV	DATE	BY	CHK	APR	DESCRIPTION	ECN
2	4-4-14	BJN	JSP	EJH	REVISED & REDRAWN PREVIOUS REVISIONS REMVD FOR CLARITY	03011-66

D10100DA/14

2

1

THIS COPY IS PROVIDED ON A RESTRICTED BASIS AND IS NOT TO BE USED IN ANY WAY DETRIMENTAL TO THE INTERESTS OF PANDUIT CORP.

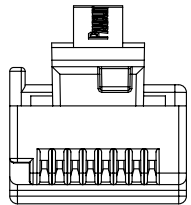
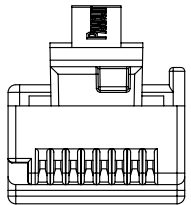
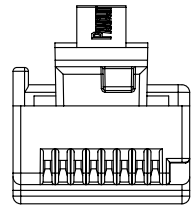
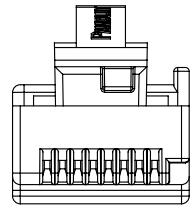
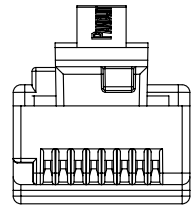
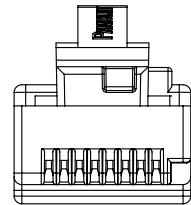
<b>**PATCH CORD COLOR/KEY CODE</b>					
A - BLACK	B - RED	C - GREEN	D - YELLOW	E - ORANGE	F - BLUE
					
BL	RD	GR	YL	OR	BU

PART NUMBER		UTPK6A**						
TITLE				<b>TX6A 10GIG UTP KEYED PATCH CORDS</b>				
CUSTOMER DRAWING								
ITEM REVISION NAME		M03011EN/00						
DATASET FILE NAME		M03011EN_DC66/00C						
UNLESS OTHERWISE SPECIFIED, DIMENSIONAL TOLERANCES ARE: IN (mm)		<b>PANDUIT</b>						
.x ± .xxx ± .010 (.3) .xx ± .03 (.8)      ANGLES ±								
DRAWING NUMBER:		03011-66						
DRAWN BY	DATE	CHK	SCALE					
MDJr	12-10-08	PBD	NONE					
REV	DATE	BY	CHK	APR	DESCRIPTION	ECN	SHT 2 OF 2	SIZE
2	4-4-14	BJN	JSP	EJH	SEE SHEET 1 OR REVISION HISTORY	03011-66		A

D10100DA/14

2

1