



MOLD CAVITY ID FOR REFERENCE ONLY



NOTES:

- MATERIAL:
 - CONNECTOR: HOUSING - HIGH TEMPERATURE THERMOPLASTIC GLASS FILLED, UL 94V-0, BLACK
 - TERMINALS - COPPER ALLOY
 - SHELL: SILVER NICKEL, C770, THICKNESS: 0.250/0.254
- FINISH:
 - CONNECTOR OPTION 1: CONTACT AREA - 0.38µm MIN GOLD OVER 2.54 µm NICKEL; SOLDER FOOT AREA - 2.54-5.09µm TIN OVER 1.27 µm NICKEL
 - CONNECTOR OPTION 2: CONTACT AREA - 0.76µm MIN GOLD OVER 2.54 µm NICKEL; SOLDER FOOT AREA - 2.54-5.09µm TIN OVER 1.27 µm NICKEL
- TERMINAL SOLDER FEET TO BE COPLANAR WITHIN 0.10 MEASURED FROM FRONT HOUSING STAND OFF (DATUM C)
- DATE CODE: 4 DIGIT (3 DIGIT DAY, 1 DIGIT YEAR) CONNECTOR ONLY
- CIRCUIT IDENTIFIER: SEE APPROPRIATE INDUSTRY SPECIFICATION FOR LOCATION OF PIN 1.
- TO BE USED WITH THE FOLLOWING CABLE SERIES: 79575/74563/79576/74573/79536/74562/74586
- PACKAGED PER PACKAGING SPECIFICATION: PK-75783-001
- CONFORMS TO PRODUCT SPECIFICATION: PS-75783-001
- PROCESS PER APPLICATION SPECIFICATION: AS-75783-001
- THIS PART CONFORMS TO CLASS C REQUIREMENTS OF COSMETIC SPEC PS-45499-002



36 CIRCUIT RETENTION FIT SHELL OPTION SHOWN

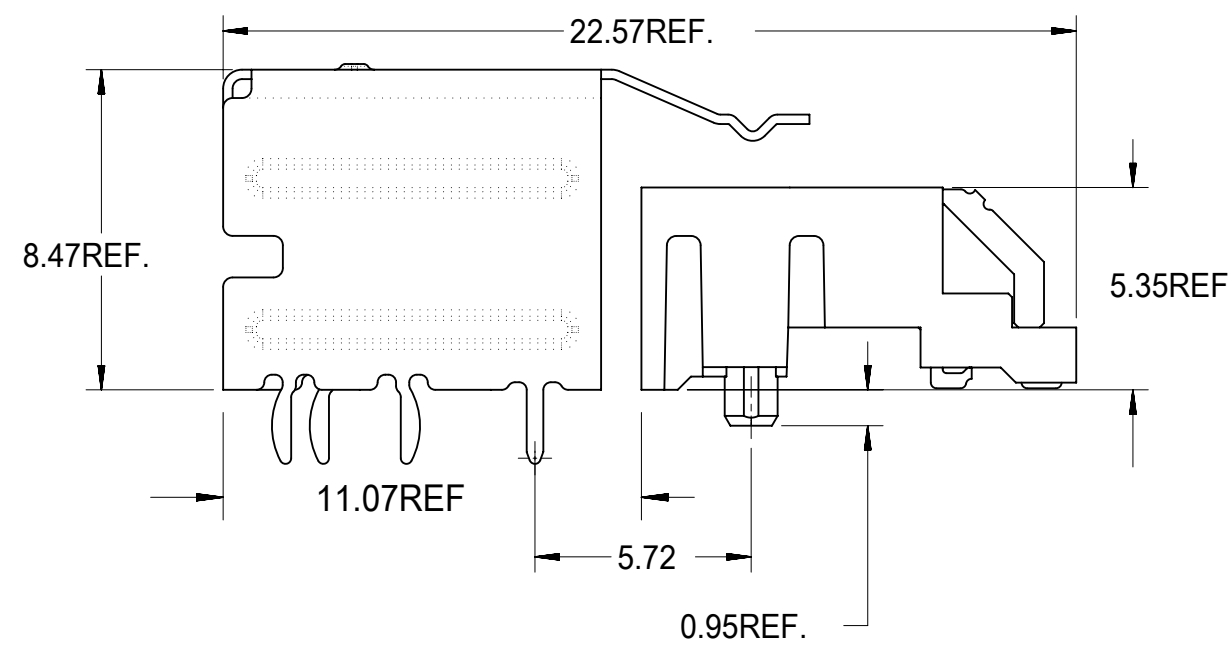

CIRCUIT SIZE	DIM 'A'	DIM 'B'	DIM 'C'
26	12.00	13.80	11.80
36	16.00	17.80	15.80
50	21.60	23.40	21.40
68	28.80	30.60	28.60

SYMBOLS		THIS DRAWING CONTAINS INFORMATION THAT IS PROPRIETARY TO MOLEX ELECTRONIC TECHNOLOGIES, LLC AND SHOULD NOT BE USED WITHOUT WRITTEN PERMISSION	
DIMENSION UNITS	SCALE	CURRENT REV DESC:	
▽ = 0	mm	1:1	EC NO: 173961 DRWN: RWHIPPLE 2018/03/19 CHK'D: SMILLER 2018/03/21 APPR: SMILLER 2018/03/21
▽ = 0	GENERAL TOLERANCES (UNLESS SPECIFIED)		
▽ = 0	ANGULAR TOL ± 0.5°		
▽ = 0	4 PLACES	±	INITIAL REVISION: DRWN: KCALLAGHAN 2016/07/21 APPR: TMCLELL 2016/08/24
▽ = 0	3 PLACES	±	
▽ = 0	2 PLACES	± 0.13	DOCUMENT NUMBER: SD-75783-001 DOC TYPE: PSD DOC PART: 001 REVISION: F
▽ = 0	1 PLACE	± 0.25	
▽ = 0	0 PLACES	±	MATERIAL NUMBER: SEE TABLE CUSTOMER: GENERAL MARKET SHEET NUMBER: 1 OF 13
▽ = 0	DRAFT WHERE APPLICABLE MUST REMAIN WITHIN DIMENSIONS		
▽ = 0	THIRD ANGLE PROJECTION	DRAWING	SERIES
		C-SIZE	75783

molex

I-PASS R/A CONNECTOR
INTERNAL ASSY W/SHELL 0.8MM PITCH I/O

PRODUCT CUSTOMER DRAWING

SD-75783-001

DOC TYPE DOC PART REVISION

PSD 001 F

MATERIAL NUMBER CUSTOMER SHEET NUMBER

SEE TABLE GENERAL MARKET 1 OF 13

RIGHT ANGLE CONNECTOR WITH SMT SHELL PCB FOOT PRINT

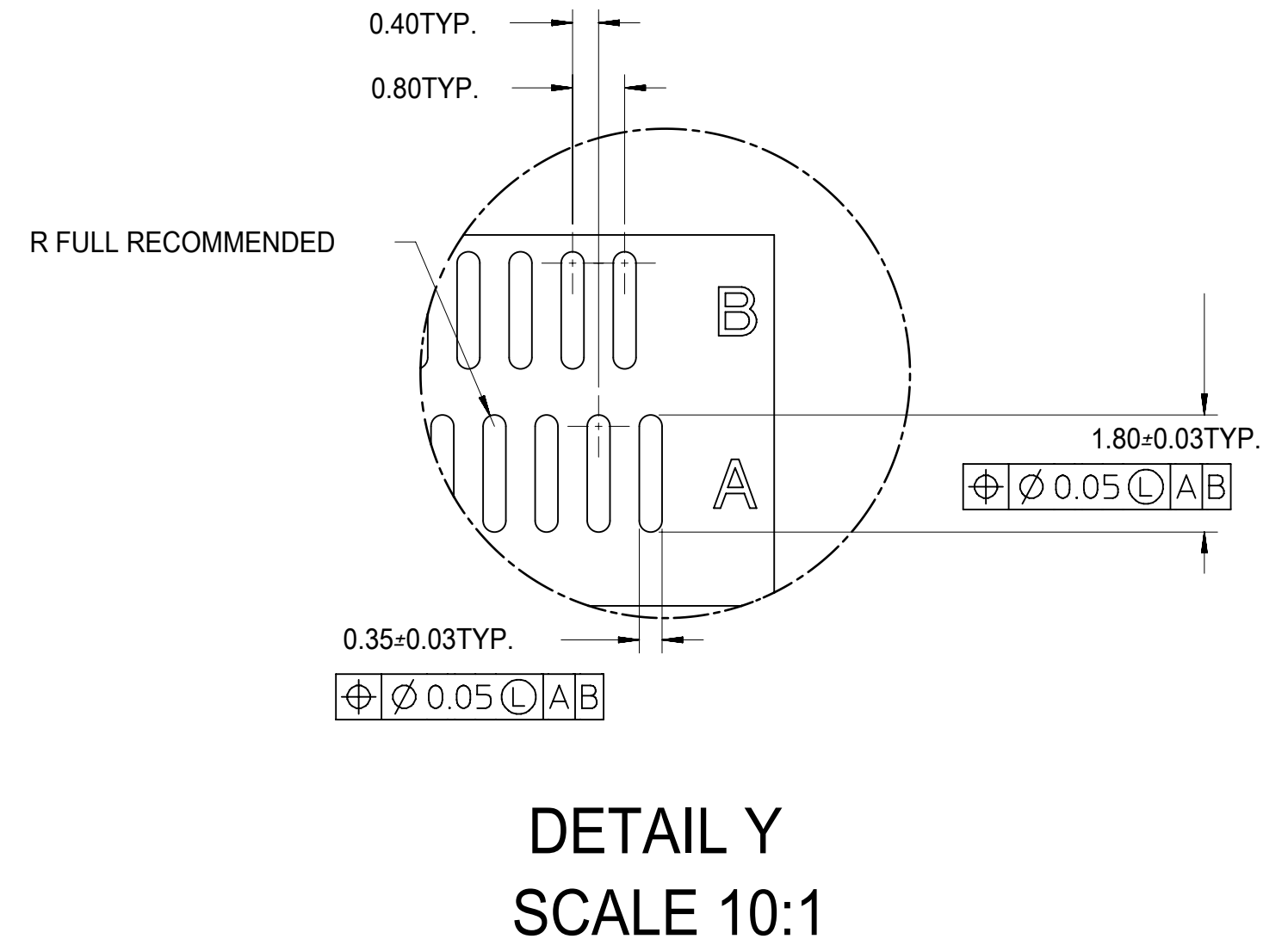
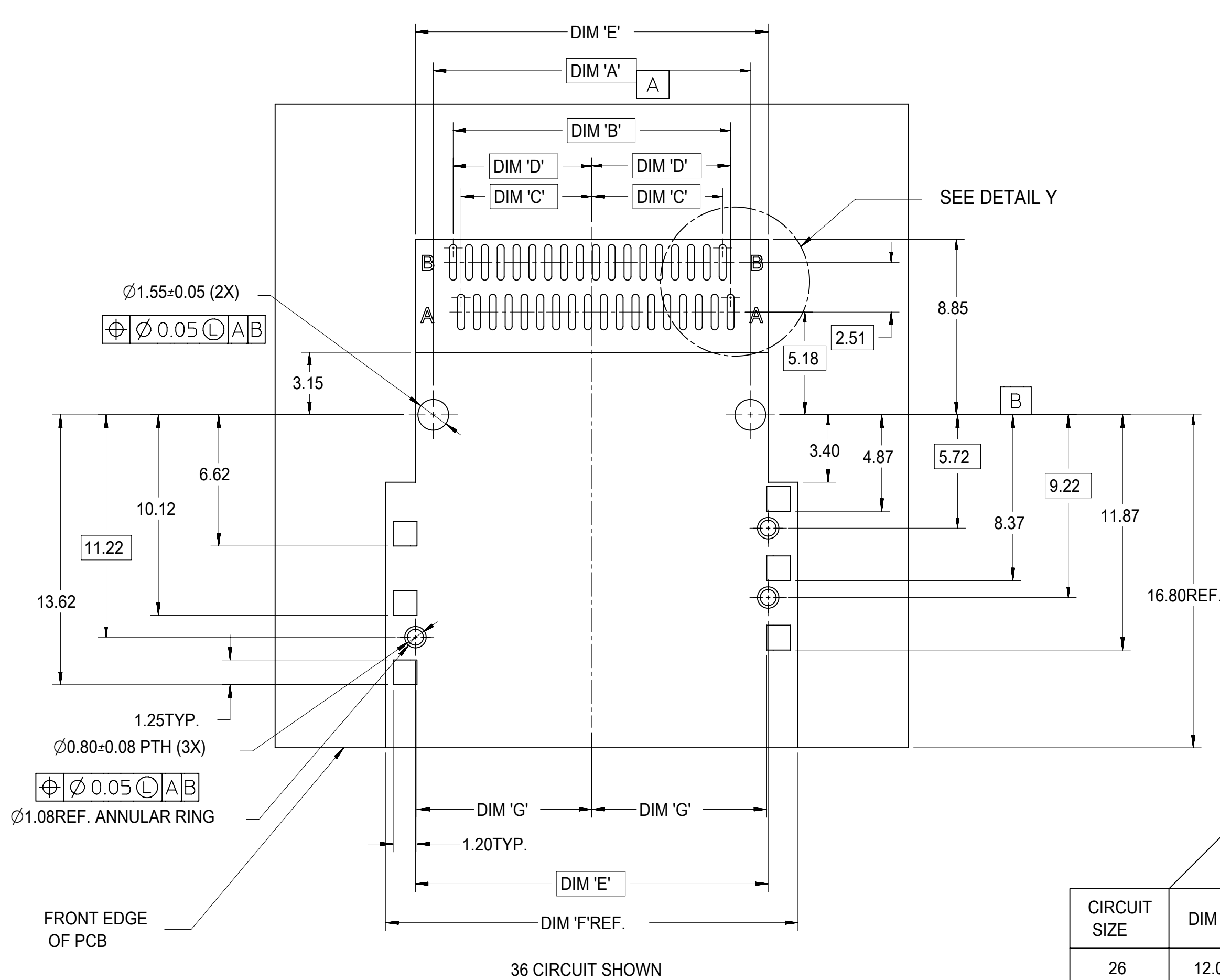

CIRCUIT SIZE	DIMENSIONS						
	PEG TO PEG	FIRST PAD TO LAST PAD	CENTERLINE TO PAD	CENTERLINE TO PAD	CONNECTOR WIDTH SHELL PEG TO PEG	SHELL FOOTPRINT WIDTH	CENTERLINE TO PAD EDGE
	DIM 'A'	DIM 'B'	DIM 'C'	DIM 'D'	DIM 'E'	DIM 'F'	DIM 'G'
26	12.00	10.00	4.60	5.00	13.80	16.80	6.825
36	16.00	14.00	6.60	7.00	17.80	20.80	8.825
50	21.60	19.60	9.40	9.80	23.40	26.40	11.625
68	28.80	26.80	13.00	13.40	30.60	33.60	15.225

SYMBOLS	THIS DRAWING CONTAINS INFORMATION THAT IS PROPRIETARY TO MOLEX ELECTRONIC TECHNOLOGIES, LLC AND SHOULD NOT BE USED WITHOUT WRITTEN PERMISSION						
	DIMENSION UNITS	SCALE	CURRENT REV DESC:				
	= 0 mm	1:1					
	= 0 GENERAL TOLERANCES (UNLESS SPECIFIED)						
= 0 ANGULAR TOL ± 0.5°		EC NO: 173961					
= 0 4 PLACES ±		DRWN: RWHIPPLE 2018/03/19				I-PASS R/A CONNECTOR	
= 0 3 PLACES ±		CHK'D: SMILLER 2018/03/21				INTERNAL ASSY W/SHELL 0.8MM PITCH I/O	
= 0 2 PLACES ± 0.13		APPR: SMILLER 2018/03/21				PRODUCT CUSTOMER DRAWING	
= 0 1 PLACE ± 0.25		INITIAL REVISION:				DOCUMENT NUMBER	
= 0 0 PLACES ±		DRWN: KCALLAGHAN 2016/07/21				SD-75783-001	
		APPR: TMCLELL 2016/08/24				DOC TYPE	
		DRAFT WHERE APPLICABLE MUST REMAIN WITHIN DIMENSIONS				DOC PART	
		THIRD ANGLE PROJECTION	DRAWING	SERIES	MATERIAL NUMBER	REVISION	
		C-SIZE	75783	SEE TABLE	GENERAL MARKET	F	
					CUSTOMER	SHEET NUMBER	
						2 OF 13	

RIGHT ANGLE CONNECTOR WITH SHELL PCB FOOT PRINT DESCRIPTIONS



36 CIRCUIT SHOWN

NOTE: IF RECEPTACLE AND SHELL ARE NOT PLACED AT EDGE OF PCB AS SHOWN, ADDITIONAL CLEARANCE IS NEEDED FOR BODY OF PLUG AND CABLE

THIS DRAWING CONTAINS INFORMATION THAT IS PROPRIETARY TO MOLEX ELECTRONIC TECHNOLOGIES, LLC AND SHOULD NOT BE USED WITHOUT WRITTEN PERMISSION										
SYMBOLS		DIMENSION UNITS	SCALE	CURRENT REV DESC:						
	= 0	mm	1:1	EC NO: 173961 DRWN: RWHIPPLE 2018/03/19 CHK'D: SMILLER 2018/03/21 APPR: SMILLER 2018/03/21						
	= 0	GENERAL TOLERANCES (UNLESS SPECIFIED)					INITIAL REVISION: DRWN: KCALLAGHAN 2016/07/21 APPR: TMCLELL 2016/08/24			PRODUCT CUSTOMER DRAWING
	= 0	ANGULAR TOL ± 0.5°		MATERIAL NUMBER: SEE TABLE CUSTOMER: GENERAL MARKET						
	= 0	4 PLACES ±					SHEET NUMBER: 3 OF 13			
	= 0	3 PLACES ±								
	= 0	2 PLACES ± 0.13								
	= 0	1 PLACE ± 0.25								
	= 0	0 PLACES ±								
	= 0	DRAFT WHERE APPLICABLE MUST REMAIN WITHIN DIMENSIONS		THIRD ANGLE PROJECTION 						
	= 0						DRAWING: C-SIZE SERIES: 75783			

MATING INTERFACE (FOR REFERENCE ONLY)

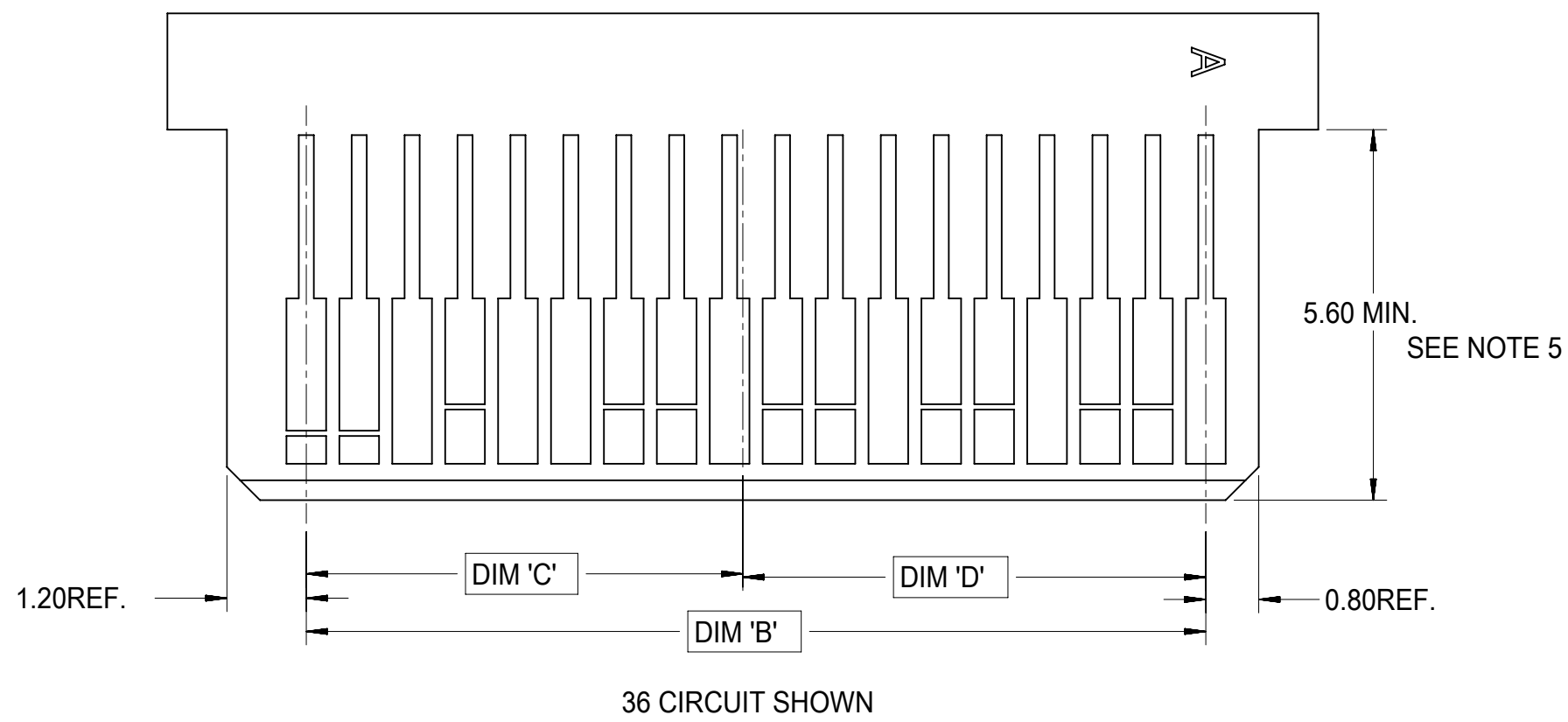
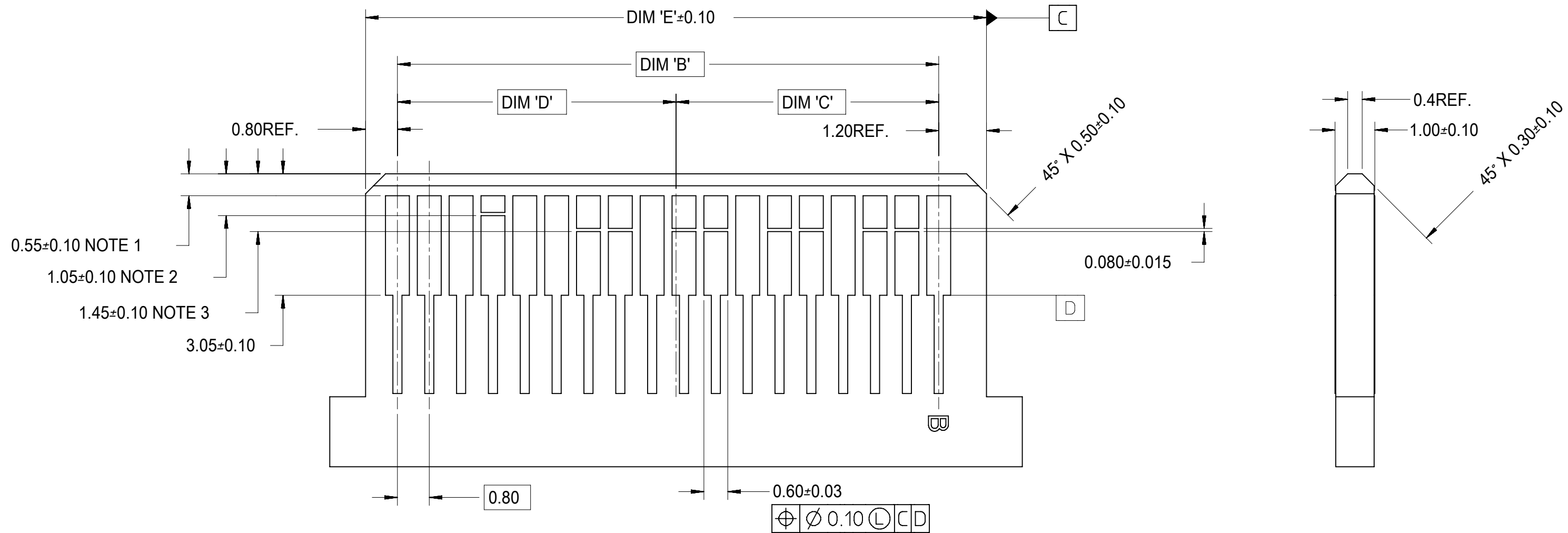

- NOTES:
- PAD CONFIGURATION FOR FIRST MATE.
 - PAD CONFIGURATION FOR SECOND MATE.
 - PAD CONFIGURATION FOR THIRD MATE. (HIGH SPEED SIGNALS)
 - FOR PIN ASSIGNMENTS AND MATING SEQUENCE (1ST, 2ND, 3RD), SEE APPLICABLE SPECIFICATION.
 - MINIMUM STEP REQUIRED IF PCB MADE WIDER THAN TONGUE.

CIRCUIT SIZE	TERM/SIDE 'N'	DIM 'B'	DIM 'C'	DIM 'D'	DIM 'E'
26	13	9.60	4.60	5.00	11.60
36	18	13.60	6.60	7.00	15.60
50	25	19.20	9.40	9.80	21.20
68	34	26.40	13.00	13.40	28.40

SYMBOLS		THIS DRAWING CONTAINS INFORMATION THAT IS PROPRIETARY TO MOLEX ELECTRONIC TECHNOLOGIES, LLC AND SHOULD NOT BE USED WITHOUT WRITTEN PERMISSION	
▽ = 0	▽ = 0	DIMENSION UNITS	SCALE
▽ = 0	▽ = 0	mm	1:1
▽ = 0	▽ = 0	CURRENT REV DESC:	
▽ = 0	▽ = 0	GENERAL TOLERANCES (UNLESS SPECIFIED)	
▽ = 0	▽ = 0	ANGULAR TOL ± 0.5°	
▽ = 0	▽ = 0	EC NO: 173961	
▽ = 0	▽ = 0	DRWN: RWHIPPLE 2018/03/19	
▽ = 0	▽ = 0	CHK'D: SMILLER 2018/03/21	
▽ = 0	▽ = 0	APPR: SMILLER 2018/03/21	
▽ = 0	▽ = 0	INITIAL REVISION:	
▽ = 0	▽ = 0	DRWN: KCALLAGHAN 2016/07/21	
▽ = 0	▽ = 0	APPR: TMCLELL 2016/08/24	
▽ = 0	▽ = 0	DRAFT WHERE APPLICABLE MUST REMAIN WITHIN DIMENSIONS	THIRD ANGLE PROJECTION
▽ = 0	▽ = 0	DRAWING	SERIES
▽ = 0	▽ = 0	C-SIZE	75783
DOCUMENT STATUS		DOC TYPE	DOC PART
P1	RELEASE DATE	PSD	001
2018/03/21	15:54:34	REVISION	
MATERIAL NUMBER		CUSTOMER	SHEET NUMBER
SD-75783-001	GENERAL MARKET	4 OF 13	

molex

I-PASS R/A CONNECTOR
INTERNAL ASSY W/SHELL 0.8MM PITCH I/O

PRODUCT CUSTOMER DRAWING

SD-75783-001

PSD 001 F

SEE TABLE GENERAL MARKET 4 OF 13

ASSEMBLY WITH PRE-POSITION DEVICE

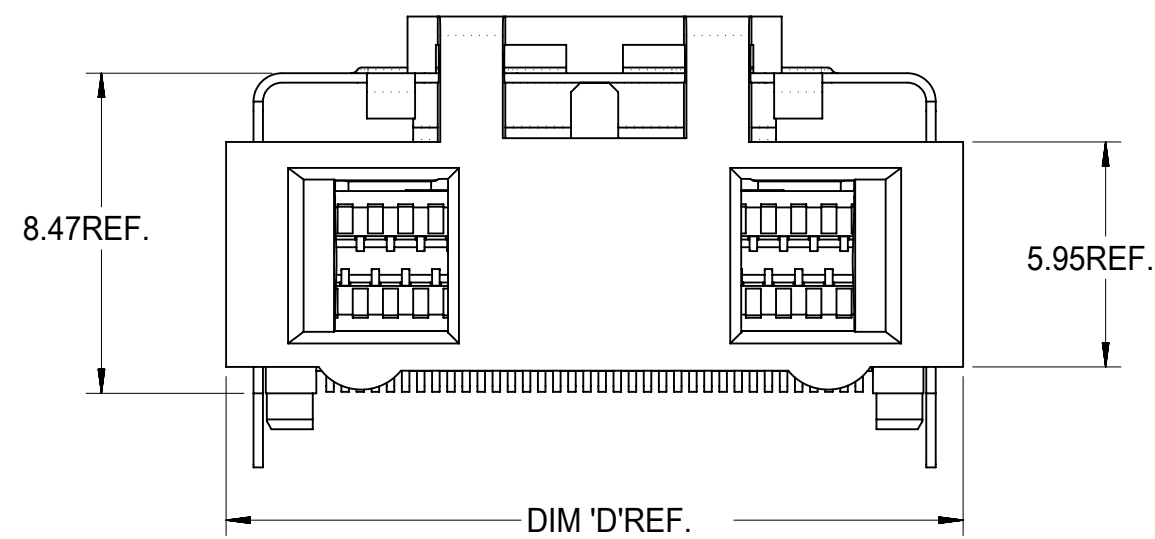
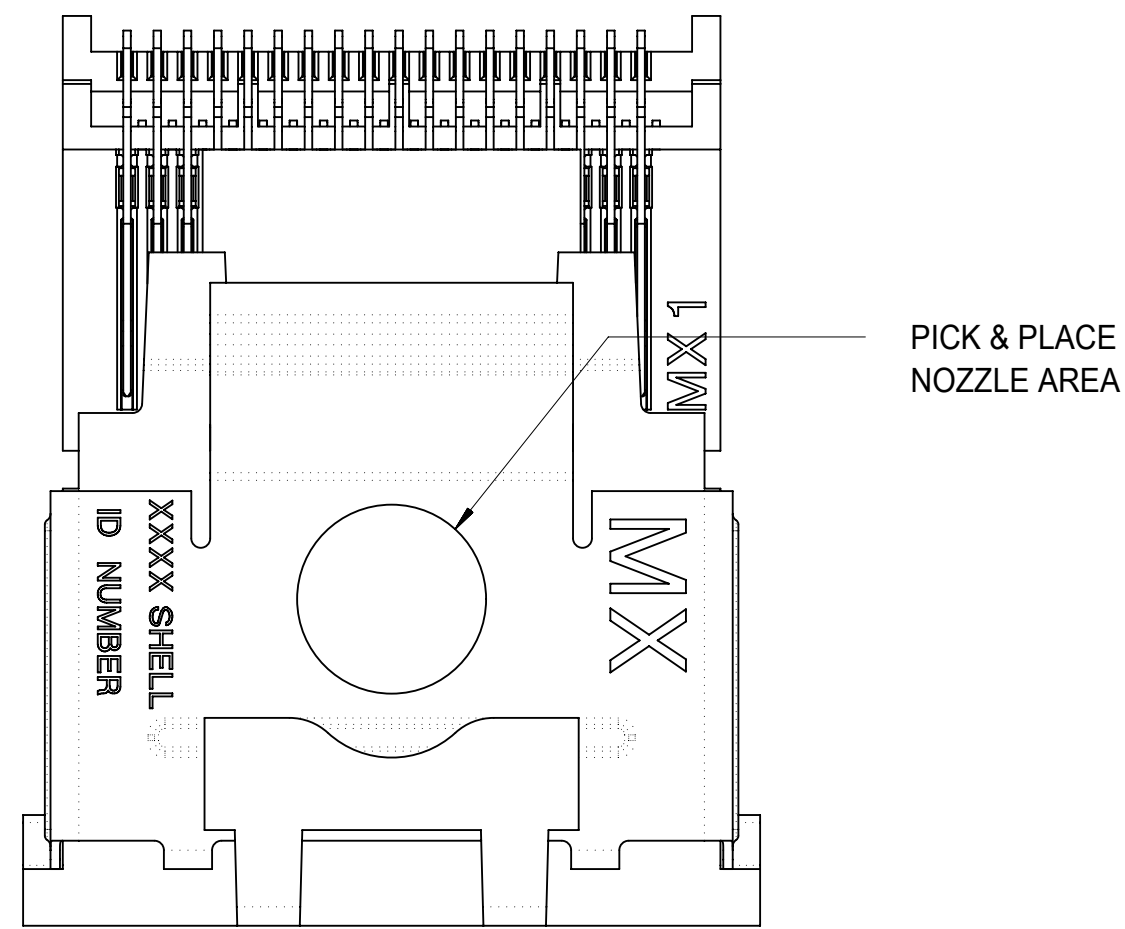

36 CIRCUIT RETENTION-FIT SHELL OPTION SHOWN



NOTES:

1. PICK AND PLACE AREA DEFINED IN APPLICATION SPECIFICATION, AS-75783-001
2. PACKAGING CONSISTS OF CONNECTOR AND SHELL WITH A PRE-POSITIONING PICK AND PLACE DEVICE THAT ARE PACKAGED IN "TAPE AND REEL" FOR ROBOTIC PICK AND PLACE.

CIRCUIT SIZE	DIM 'D'
26	15.50
36	19.50
50	25.10
68	32.30

SYMBOLS		THIS DRAWING CONTAINS INFORMATION THAT IS PROPRIETARY TO MOLEX ELECTRONIC TECHNOLOGIES, LLC AND SHOULD NOT BE USED WITHOUT WRITTEN PERMISSION	
DIMENSION UNITS	SCALE	CURRENT REV DESC:	
$\nabla = 0$	mm	1:1	
$\nabla = 0$	GENERAL TOLERANCES (UNLESS SPECIFIED)		
$\nabla = 0$	ANGULAR TOL $\pm 0.5^\circ$		
$\nabla = 0$	4 PLACES	\pm	
$\nabla = 0$	3 PLACES	\pm	
$\nabla = 0$	2 PLACES	± 0.13	
$\nabla = 0$	1 PLACE	± 0.25	
$\nabla = 0$	0 PLACES	\pm	
$\nabla = 0$	DRAFT WHERE APPLICABLE MUST REMAIN WITHIN DIMENSIONS		
	THIRD ANGLE PROJECTION	DRAWING	SERIES
		C-SIZE	75783
	EC NO: 173961		
	DRWN: RWHIPPLE	2018/03/19	
	CHK'D: SMILLER	2018/03/21	
	APPR: SMILLER	2018/03/21	
	INITIAL REVISION:		
	DRWN: KCALLAGHAN	2016/07/21	
	APPR: TMCLELL	2016/08/24	
	DOCUMENT NUMBER		DOC TYPE DOC PART REVISION
	SD-75783-001		PSD 001 F
	MATERIAL NUMBER	CUSTOMER	SHEET NUMBER
	SEE TABLE	GENERAL MARKET	5 OF 13

molex

I-PASS R/A CONNECTOR
INTERNAL ASSY W/SHELL 0.8MM PITCH I/O

PRODUCT CUSTOMER DRAWING

KEYING OPTIONS



	UNIVERSAL SHELL	LEFT KEY SHELL	RIGHT KEY SHELL	DUAL KEY SHELL
NO KEY PLUG	YES	NO	NO	NO
LEFT KEY PLUG	YES	YES	NO	NO
RIGHT KEY PLUG	YES	NO	YES	NO
UNIVERSAL PLUG	YES	YES	YES	YES

THIS DRAWING CONTAINS INFORMATION THAT IS PROPRIETARY TO MOLEX ELECTRONIC TECHNOLOGIES, LLC AND SHOULD NOT BE USED WITHOUT WRITTEN PERMISSION											
SYMBOLS		DIMENSION UNITS		SCALE		CURRENT REV DESC:					
▽ = 0	▽ = 0	mm		1:1		molex I-PASS R/A CONNECTOR INTERNAL ASSY W/SHELL 0.8MM PITCH I/O PRODUCT CUSTOMER DRAWING EC NO: 173961 DRWN: RWHIPPLE 2018/03/19 CHK'D: SMILLER 2018/03/21 APPR: SMILLER 2018/03/21 INITIAL REVISION: DRWN: KCALLAGHAN 2016/07/21 APPR: TMCLELL 2016/08/24 THIRD ANGLE PROJECTION DRAWING SERIES C-SIZE 75783					
▽ = 0	▽ = 0	GENERAL TOLERANCES (UNLESS SPECIFIED)									
▽ = 0	▽ = 0	ANGULAR TOL ± 0.5°									
▽ = 0	▽ = 0	4 PLACES ±									
▽ = 0	▽ = 0	3 PLACES ±									
▽ = 0	▽ = 0	2 PLACES ± 0.13									
▽ = 0	▽ = 0	1 PLACE ± 0.25									
▽ = 0	▽ = 0	0 PLACES ±									
▽ = 0	▽ = 0	DRAFT WHERE APPLICABLE MUST REMAIN WITHIN DIMENSIONS				MATERIAL NUMBER		CUSTOMER		SHEET NUMBER	
▽ = 0	▽ = 0					SEE TABLE		GENERAL MARKET		7 OF 13	

26 CIRCUIT ITEM NUMBERS

CIRCUIT SIZE	ITEM NUMBER	PLATING OPTION	SHELL PCB OPTION	SHELL KEY OPTION
26	75783-0007	OPTION 1	RETENTION	LEFT
26	75783-0008	OPTION 1	RETENTION	RIGHT
26	75783-0009	OPTION 1	RETENTION	DUAL
26	75783-0010	OPTION 1	SMT	LEFT
26	75783-0011	OPTION 1	SMT	RIGHT
26	75783-0012	OPTION 1	SMT	DUAL
26	75783-0019	OPTION 2	RETENTION	LEFT
26	75783-0020	OPTION 2	RETENTION	RIGHT
26	75783-0021	OPTION 2	RETENTION	DUAL
26	75783-0022	OPTION 2	SMT	LEFT
26	75783-0023	OPTION 2	SMT	RIGHT
26	75783-0024	OPTION 2	SMT	DUAL
26	75783-0025	OPTION 1	RETENTION	UNIVERSAL
26	75783-0026	OPTION 1	SMT	UNIVERSAL
26	75783-0027	OPTION 2	RETENTION	UNIVERSAL
26	75783-0028	OPTION 2	SMT	UNIVERSAL
26	75783-0029	OPTION 1	T/H 1.96	LEFT
26	75783-0030	OPTION 1	T/H 1.96	RIGHT
26	75783-0031	OPTION 1	T/H 1.96	DUAL
26	75783-0032	OPTION 1	T/H 1.96	UNIVERSAL
26	75783-0033	OPTION 2	T/H 1.96	LEFT
26	75783-0034	OPTION 2	T/H 1.96	RIGHT
26	75783-0035	OPTION 2	T/H 1.96	DUAL
26	75783-0036	OPTION 2	T/H 1.96	UNIVERSAL

CIRCUIT SIZE	ITEM NUMBER	PLATING OPTION	SHELL PCB OPTION	SHELL KEY OPTION
26	75783-0037	OPTION 1	T/H 2.79	LEFT
26	75783-0038	OPTION 1	T/H 2.79	RIGHT
26	75783-0039	OPTION 1	T/H 2.79	DUAL
26	75783-0040	OPTION 1	T/H 2.79	UNIVERSAL
26	75783-0041	OPTION 2	T/H 2.79	LEFT
26	75783-0042	OPTION 2	T/H 2.79	RIGHT
26	75783-0043	OPTION 2	T/H 2.79	DUAL
26	75783-0044	OPTION 2	T/H 2.79	UNIVERSAL
26	75783-0045	OPTION 1	T/H 3.18	LEFT
26	75783-0046	OPTION 1	T/H 3.18	RIGHT
26	75783-0047	OPTION 1	T/H 3.18	DUAL
26	75783-0048	OPTION 1	T/H 3.18	UNIVERSAL
26	75783-0049	OPTION 2	T/H 3.18	LEFT
26	75783-0050	OPTION 2	T/H 3.18	RIGHT
26	75783-0051	OPTION 2	T/H 3.18	DUAL
26	75783-0052	OPTION 2	T/H 3.18	UNIVERSAL

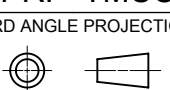
THIS DRAWING CONTAINS INFORMATION THAT IS PROPRIETARY TO MOLEX ELECTRONIC TECHNOLOGIES, LLC AND SHOULD NOT BE USED WITHOUT WRITTEN PERMISSION									
SYMBOLS	DIMENSION UNITS	SCALE	CURRENT REV DESC:						
	mm	1:1							
▽ = 0	GENERAL TOLERANCES (UNLESS SPECIFIED)		EC NO: 173961				I-PASS R/A CONNECTOR INTERNAL ASSY W/SHELL 0.8MM PITCH I/O		
▽ = 0	ANGULAR TOL ± 0.5°		DRWN: RWHIPPLE 2018/03/19						
▽ = 0	4 PLACES ±		CHK'D: SMILLER 2018/03/21				PRODUCT CUSTOMER DRAWING		
▽ = 0	3 PLACES ±		APPR: SMILLER 2018/03/21						
▽ = 0	2 PLACES ± 0.13		INITIAL REVISION:				DOCUMENT NUMBER SD-75783-001		
▽ = 0	1 PLACE ± 0.25		DRWN: KCALLAGHAN 2016/07/21						
▽ = 0	0 PLACES ±		APPR: TMCLELL 2016/08/24				DOC TYPE DOC PART REVISION PSD 001 F		
▽ = 0	DRAFT WHERE APPLICABLE MUST REMAIN WITHIN DIMENSIONS		THIRD ANGLE PROJECTION		DRAWING	SERIES			
▽ = 0					C-SIZE	75783	SEE TABLE GENERAL MARKET 8 OF 13		

36 CIRCUIT ITEM NUMBERS

CIRCUIT SIZE	ITEM NUMBER	PLATING OPTION	SHELL PCB OPTION	SHELL KEY OPTION
36	75783-0107	OPTION 1	RETENTION	LEFT
36	75783-0108	OPTION 1	RETENTION	RIGHT
36	75783-0109	OPTION 1	RETENTION	DUAL
36	75783-0110	OPTION 1	SMT	LEFT
36	75783-0111	OPTION 1	SMT	RIGHT
36	75783-0112	OPTION 1	SMT	DUAL
36	75783-0119	OPTION 2	RETENTION	LEFT
36	75783-0120	OPTION 2	RETENTION	RIGHT
36	75783-0121	OPTION 2	RETENTION	DUAL
36	75783-0122	OPTION 2	SMT	LEFT
36	75783-0123	OPTION 2	SMT	RIGHT
36	75783-0124	OPTION 2	SMT	DUAL
36	75783-0125	OPTION 1	RETENTION	UNIVERSAL
36	75783-0126	OPTION 1	SMT	UNIVERSAL
36	75783-0127	OPTION 2	RETENTION	UNIVERSAL
36	75783-0128	OPTION 2	SMT	UNIVERSAL
36	75783-0129	OPTION 1	T/H 1.96	LEFT
36	75783-0130	OPTION 1	T/H 1.96	RIGHT
36	75783-0131	OPTION 1	T/H 1.96	DUAL
36	75783-0132	OPTION 1	T/H 1.96	UNIVERSAL
36	75783-0133	OPTION 2	T/H 1.96	LEFT
36	75783-0134	OPTION 2	T/H 1.96	RIGHT
36	75783-0135	OPTION 2	T/H 1.96	DUAL
36	75783-0136	OPTION 2	T/H 1.96	UNIVERSAL
36	75783-0170	OPTION 1	T/H 1.40	UNIVERSAL











CIRCUIT SIZE	ITEM NUMBER	PLATING OPTION	SHELL PCB OPTION	SHELL KEY OPTION
36	75783-0137	OPTION 1	T/H 2.79	LEFT
36	75783-0138	OPTION 1	T/H 2.79	RIGHT
36	75783-0139	OPTION 1	T/H 2.79	DUAL
36	75783-0140	OPTION 1	T/H 2.79	UNIVERSAL
36	75783-0141	OPTION 2	T/H 2.79	LEFT
36	75783-0142	OPTION 2	T/H 2.79	RIGHT
36	75783-0143	OPTION 2	T/H 2.79	DUAL
36	75783-0144	OPTION 2	T/H 2.79	UNIVERSAL
36	75783-0145	OPTION 1	T/H 3.18	LEFT
36	75783-0146	OPTION 1	T/H 3.18	RIGHT
36	75783-0147	OPTION 1	T/H 3.18	DUAL
36	75783-0148	OPTION 1	T/H 3.18	UNIVERSAL
36	75783-0149	OPTION 2	T/H 3.18	LEFT
36	75783-0150	OPTION 2	T/H 3.18	RIGHT
36	75783-0151	OPTION 2	T/H 3.18	DUAL
36	75783-0152	OPTION 2	T/H 3.18	UNIVERSAL
36	75783-0153	OPTION 1	T/H 3.56	LEFT
36	75783-0154	OPTION 1	T/H 3.56	RIGHT
36	75783-0155	OPTION 1	T/H 3.56	DUAL
36	75783-0156	OPTION 1	T/H 3.56	UNIVERSAL
36	75783-0157	OPTION 2	T/H 3.56	LEFT
36	75783-0158	OPTION 2	T/H 3.56	RIGHT
36	75783-0159	OPTION 2	T/H 3.56	DUAL
36	75783-0160	OPTION 2	T/H 3.56	UNIVERSAL

SYMBOLS  = 0  = 0  = 0  = 0  = 0  = 0  = 0  = 0	THIS DRAWING CONTAINS INFORMATION THAT IS PROPRIETARY TO MOLEX ELECTRONIC TECHNOLOGIES, LLC AND SHOULD NOT BE USED WITHOUT WRITTEN PERMISSION		DIMENSION UNITS: mm SCALE: 1:1		CURRENT REV DESC: EC NO: 173961 DRWN: RWHIPPLE 2018/03/19 CHK'D: SMILLER 2018/03/21 APPR: SMILLER 2018/03/21		 I-PASS R/A CONNECTOR INTERNAL ASSY W/SHELL 0.8MM PITCH I/O	
	GENERAL TOLERANCES (UNLESS SPECIFIED) ANGULAR TOL ± 0.5°		4 PLACES ± 3 PLACES ± 2 PLACES ± 0.13 1 PLACE ± 0.25 0 PLACES ±		INITIAL REVISION: DRWN: KCALLAGHAN 2016/07/21 APPR: TMCLELL 2016/08/24			
	DRAFT WHERE APPLICABLE MUST REMAIN WITHIN DIMENSIONS		THIRD ANGLE PROJECTION		DRAWING: C-SIZE SERIES: 75783		DOCUMENT NUMBER: SD-75783-001 DOC TYPE: PSD DOC PART: 001 REVISION: F	
	MATERIAL NUMBER: SEE TABLE CUSTOMER: GENERAL MARKET		SHEET NUMBER: 9 OF 13					

50 CIRCUIT ITEM NUMBERS

CIRCUIT SIZE	ITEM NUMBER	PLATING OPTION	SHELL PCB OPTION	SHELL KEY OPTION
50	75783-0207	OPTION 1	RETENTION	LEFT
50	75783-0208	OPTION 1	RETENTION	RIGHT
50	75783-0209	OPTION 1	RETENTION	DUAL
50	75783-0210	OPTION 1	SMT	LEFT
50	75783-0211	OPTION 1	SMT	RIGHT
50	75783-0212	OPTION 1	SMT	DUAL
50	75783-0219	OPTION 2	RETENTION	LEFT
50	75783-0220	OPTION 2	RETENTION	RIGHT
50	75783-0221	OPTION 2	RETENTION	DUAL
50	75783-0222	OPTION 2	SMT	LEFT
50	75783-0223	OPTION 2	SMT	RIGHT
50	75783-0224	OPTION 2	SMT	DUAL
50	75783-0225	OPTION 1	RETENTION	UNIVERSAL
50	75783-0226	OPTION 1	SMT	UNIVERSAL
50	75783-0227	OPTION 2	RETENTION	UNIVERSAL
50	75783-0228	OPTION 2	SMT	UNIVERSAL
50	75783-0229	OPTION 1	T/H 1.96	LEFT
50	75783-0230	OPTION 1	T/H 1.96	RIGHT
50	75783-0231	OPTION 1	T/H 1.96	DUAL
50	75783-0232	OPTION 1	T/H 1.96	UNIVERSAL
50	75783-0233	OPTION 2	T/H 1.96	LEFT
50	75783-0234	OPTION 2	T/H 1.96	RIGHT
50	75783-0235	OPTION 2	T/H 1.96	DUAL
50	75783-0236	OPTION 2	T/H 1.96	UNIVERSAL

CIRCUIT SIZE	ITEM NUMBER	PLATING OPTION	SHELL PCB OPTION	SHELL KEY OPTION
50	75783-0237	OPTION 1	T/H 2.79	LEFT
50	75783-0238	OPTION 1	T/H 2.79	RIGHT
50	75783-0239	OPTION 1	T/H 2.79	DUAL
50	75783-0240	OPTION 1	T/H 2.79	UNIVERSAL
50	75783-0241	OPTION 2	T/H 2.79	LEFT
50	75783-0242	OPTION 2	T/H 2.79	RIGHT
50	75783-0243	OPTION 2	T/H 2.79	DUAL
50	75783-0244	OPTION 2	T/H 2.79	UNIVERSAL
50	75783-0245	OPTION 1	T/H 3.18	LEFT
50	75783-0246	OPTION 1	T/H 3.18	RIGHT
50	75783-0247	OPTION 1	T/H 3.18	DUAL
50	75783-0248	OPTION 1	T/H 3.18	UNIVERSAL
50	75783-0249	OPTION 2	T/H 3.18	LEFT
50	75783-0250	OPTION 2	T/H 3.18	RIGHT
50	75783-0251	OPTION 2	T/H 3.18	DUAL
50	75783-0252	OPTION 2	T/H 3.18	UNIVERSAL

SYMBOLS  = 0  = 0  = 0  = 0  = 0  = 0  = 0  = 0  = 0	THIS DRAWING CONTAINS INFORMATION THAT IS PROPRIETARY TO MOLEX ELECTRONIC TECHNOLOGIES, LLC AND SHOULD NOT BE USED WITHOUT WRITTEN PERMISSION		DIMENSION UNITS: mm		SCALE: 1:1		CURRENT REV DESC:											
	GENERAL TOLERANCES (UNLESS SPECIFIED)		ANGULAR TOL ± 0.5°		EC NO: 173961		DRWN: RWHIPPLE 2018/03/19						I-PASS R/A CONNECTOR INTERNAL ASSY W/SHELL 0.8MM PITCH I/O					
	4 PLACES ±		3 PLACES ±		APPR: SMILLER 2018/03/21		2018/03/21		PRODUCT CUSTOMER DRAWING									
	2 PLACES ± 0.13		1 PLACE ± 0.25		INITIAL REVISION:		DRWN: KCALLAGHAN 2016/07/21		APPR: TMCLELL 2016/08/24		DOCUMENT NUMBER: SD-75783-001		DOC TYPE: PSD		DOC PART: 001		REVISION: F	
	0 PLACES ±		DRAFT WHERE APPLICABLE MUST REMAIN WITHIN DIMENSIONS		THIRD ANGLE PROJECTION		DRAWING: C-SIZE		SERIES: 75783		MATERIAL NUMBER: SEE TABLE		CUSTOMER: GENERAL MARKET		SHEET NUMBER: 10 OF 13			

68 CIRCUIT ITEM NUMBERS

CIRCUIT SIZE	ITEM NUMBER	PLATING OPTION	SHELL PCB OPTION	SHELL KEY OPTION
68	75783-0307	OPTION 1	RETENTION	LEFT
68	75783-0308	OPTION 1	RETENTION	RIGHT
68	75783-0309	OPTION 1	RETENTION	DUAL
68	75783-0310	OPTION 1	SMT	LEFT
68	75783-0311	OPTION 1	SMT	RIGHT
68	75783-0312	OPTION 1	SMT	DUAL
68	75783-0319	OPTION 2	RETENTION	LEFT
68	75783-0320	OPTION 2	RETENTION	RIGHT
68	75783-0321	OPTION 2	RETENTION	DUAL
68	75783-0322	OPTION 2	SMT	LEFT
68	75783-0323	OPTION 2	SMT	RIGHT
68	75783-0324	OPTION 2	SMT	DUAL
68	75783-0325	OPTION 1	RETENTION	UNIVERSAL
68	75783-0326	OPTION 1	SMT	UNIVERSAL
68	75783-0327	OPTION 2	RETENTION	UNIVERSAL
68	75783-0328	OPTION 2	SMT	UNIVERSAL
68	75783-0329	OPTION 1	T/H 1.96	LEFT
68	75783-0330	OPTION 1	T/H 1.96	RIGHT
68	75783-0331	OPTION 1	T/H 1.96	DUAL
68	75783-0332	OPTION 1	T/H 1.96	UNIVERSAL
68	75783-0333	OPTION 2	T/H 1.96	LEFT
68	75783-0334	OPTION 2	T/H 1.96	RIGHT
68	75783-0335	OPTION 2	T/H 1.96	DUAL
68	75783-0336	OPTION 2	T/H 1.96	UNIVERSAL

CIRCUIT SIZE	ITEM NUMBER	PLATING OPTION	SHELL PCB OPTION	SHELL KEY OPTION
68	75783-0337	OPTION 1	T/H 2.79	LEFT
68	75783-0338	OPTION 1	T/H 2.79	RIGHT
68	75783-0339	OPTION 1	T/H 2.79	DUAL
68	75783-0340	OPTION 1	T/H 2.79	UNIVERSAL
68	75783-0341	OPTION 2	T/H 2.79	LEFT
68	75783-0342	OPTION 2	T/H 2.79	RIGHT
68	75783-0343	OPTION 2	T/H 2.79	DUAL
68	75783-0344	OPTION 2	T/H 2.79	UNIVERSAL
68	75783-0345	OPTION 1	T/H 3.18	LEFT
68	75783-0346	OPTION 1	T/H 3.18	RIGHT
68	75783-0347	OPTION 1	T/H 3.18	DUAL
68	75783-0348	OPTION 1	T/H 3.18	UNIVERSAL
68	75783-0349	OPTION 2	T/H 3.18	LEFT
68	75783-0350	OPTION 2	T/H 3.18	RIGHT
68	75783-0351	OPTION 2	T/H 3.18	DUAL
68	75783-0352	OPTION 2	T/H 3.18	UNIVERSAL

SYMBOLS = 0 = 0 = 0 = 0 = 0 = 0 = 0 = 0 = 0	THIS DRAWING CONTAINS INFORMATION THAT IS PROPRIETARY TO MOLEX ELECTRONIC TECHNOLOGIES, LLC AND SHOULD NOT BE USED WITHOUT WRITTEN PERMISSION			
	DIMENSION UNITS	SCALE	CURRENT REV DESC:	
	mm	1:1		
	GENERAL TOLERANCES (UNLESS SPECIFIED)		EC NO: 173961	
	ANGULAR TOL	± 0.5°	DRWN: RWHIPPLE	2018/03/19
	4 PLACES	±	CHK'D: SMILLER	2018/03/21
	3 PLACES	±	APPR: SMILLER	2018/03/21
	2 PLACES	± 0.13	INITIAL REVISION:	
	1 PLACE	± 0.25	DRWN: KCALLAGHAN	2016/07/21
	0 PLACES	±	APPR: TMCLELL	2016/08/24
DRAFT WHERE APPLICABLE MUST REMAIN WITHIN DIMENSIONS		THIRD ANGLE PROJECTION	DRAWING	SERIES
			C-SIZE	75783
DOCUMENT STATUS		DOCUMENT NUMBER	DOC TYPE	DOC PART
P1	RELEASE DATE	SD-75783-001	PSD	001
2018/03/21	15:54:34	CUSTOMER	GENERAL MARKET	SHEET NUMBER
		SEE TABLE		11 OF 13



I-PASS R/A CONNECTOR
INTERNAL ASSY W/SHELL 0.8MM PITCH I/O

PRODUCT CUSTOMER DRAWING

RIGHT ANGLE CONNECTOR WITH RETENTION FIT & THRU-HOLE SHELL PCB FOOT PRINT



DETAIL Z
SCALE 10:1

	PEG TO PEG	FIRST PAD TO LAST PAD	CENTERLINE TO PAD	CENTERLINE TO PAD	CONNECTOR WIDTH SHELL PEG TO PEG	SHELL FOOTPRINT WIDTH
CIRCUIT SIZE	DIM 'A'	DIM 'B'	DIM 'C'	DIM 'D'	DIM 'E'	DIM 'F'
26	12.00	10.00	4.60	5.00	13.80	15.80
36	16.00	14.00	6.60	7.00	17.80	19.80
50	21.60	19.60	9.40	9.80	23.40	25.40
68	28.80	26.80	13.00	13.40	30.60	32.60

SYMBOLS		THIS DRAWING CONTAINS INFORMATION THAT IS PROPRIETARY TO MOLEX ELECTRONIC TECHNOLOGIES, LLC AND SHOULD NOT BE USED WITHOUT WRITTEN PERMISSION					
DIMENSION UNITS	SCALE	CURRENT REV DESC:					
= 0	mm	1:1	 I-PASS R/A CONNECTOR INTERNAL ASSY W/SHELL 0.8MM PITCH I/O PRODUCT CUSTOMER DRAWING				
= 0	GENERAL TOLERANCES (UNLESS SPECIFIED)					EC NO: 173961	2018/03/19
= 0	ANGULAR TOL ± 0.5°					DRWN: RWHIPPLE	2018/03/21
= 0	4 PLACES ±					CHK'D: SMILLER	2018/03/21
= 0	3 PLACES ±					APPR: SMILLER	2018/03/21
= 0	2 PLACES ± 0.13		INITIAL REVISION:				
= 0	1 PLACE ± 0.25		DRWN: KCALLAGHAN	2016/07/21			
= 0	0 PLACES ±		APPR: TMCLELL	2016/08/24			
= 0	DRAFT WHERE APPLICABLE MUST REMAIN WITHIN DIMENSIONS		THIRD ANGLE PROJECTION	DRAWING	SERIES		
				C-SIZE	75783		
DOCUMENT NUMBER		DOC TYPE	DOC PART	REVISION			
SD-75783-001		PSD	001	F			
MATERIAL NUMBER		CUSTOMER		SHEET NUMBER			
SEE TABLE		GENERAL MARKET		12 OF 13			

H
G
F
E
D
C
B
A

DATE	REV	DESCRIPTION
2018/03/20	F	1. REMASTERED FROM MODEL MANAGER
		2. SHEET 1, NOTE 3, COPLANAR DISTANCE CHANGED FROM 0.15 TO 0.10

THIS DRAWING CONTAINS INFORMATION THAT IS PROPRIETARY TO MOLEX ELECTRONIC TECHNOLOGIES, LLC AND SHOULD NOT BE USED WITHOUT WRITTEN PERMISSION										
SYMBOLS  = 0  = 0  = 0  = 0  = 0  = 0  = 0  = 0  = 0	DIMENSION UNITS	SCALE	CURRENT REV DESC:							
	mm	1:1	EC NO: 173961 DRWN: RWHIPPLE 2018/03/19 CHK'D: SMILLER 2018/03/21 APPR: SMILLER 2018/03/21							
	GENERAL TOLERANCES (UNLESS SPECIFIED)									
	ANGULAR TOL	± 0.5°								
	4 PLACES	±	INITIAL REVISION: DRWN: KCALLAGHAN 2016/07/21 APPR: TMCLELL 2016/08/24							
	3 PLACES	±								
	2 PLACES	± 0.13								
	1 PLACE	± 0.25	THIRD ANGLE PROJECTION		DRAWING	SERIES	MATERIAL NUMBER	CUSTOMER	SHEET NUMBER	
	0 PLACES	±			C-SIZE	75783	SEE TABLE	GENERAL MARKET	13 OF 13	
	DRAFT WHERE APPLICABLE MUST REMAIN WITHIN DIMENSIONS									



I-PASS R/A CONNECTOR
INTERNAL ASSY W/SHELL 0.8MM PITCH I/O

PRODUCT CUSTOMER DRAWING

DOCUMENT NUMBER	DOC TYPE	DOC PART	REVISION
SD-75783-001	PSD	001	F