

MODEL: CPI-2316-5-85T | **DESCRIPTION:** PIEZO BUZZER INDICATOR**FEATURES**

- 5 Vdc rated
- 90 dB
- continuous tone

**SPECIFICATIONS**

parameter	conditions/description	min	typ	max	units
rated voltage			5		Vdc
operating voltage		3		15	Vdc
current consumption	at rated voltage			15	mA
rated frequency		3,000	3,500	4,000	Hz
sound pressure level	at 10 cm, rated voltage	85	90		dB
tone	continuous				
dimensions	Ø23.5 x 16.0				mm
weight				5.2	g
material	PPD (black)				
terminal	pins (tin plating)				
operating temperature		-35		75	°C
storage temperature		-40		85	°C
washable	no				
RoHS	yes				

Notes: 1. All specifications measured at 25±3°C, humidity at 60-70%, under 86-106 kPa pressure, unless otherwise noted.

SOLDERABILITY

parameter	conditions/description	min	typ	max	units
hand soldering	for maximum 2 seconds	330		380	°C
wave soldering	see recommended wave soldering profile			250	°C

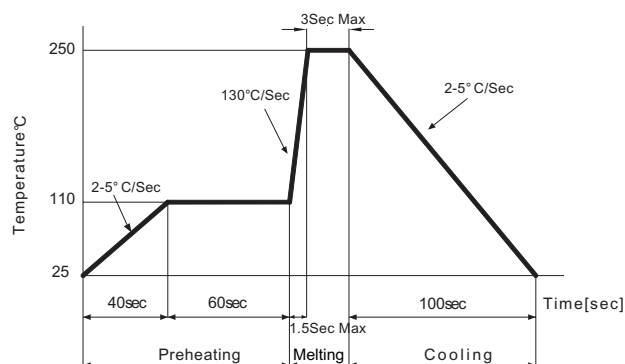

MECHANICAL DRAWING

units: mm
tolerance: ± 0.5 mm

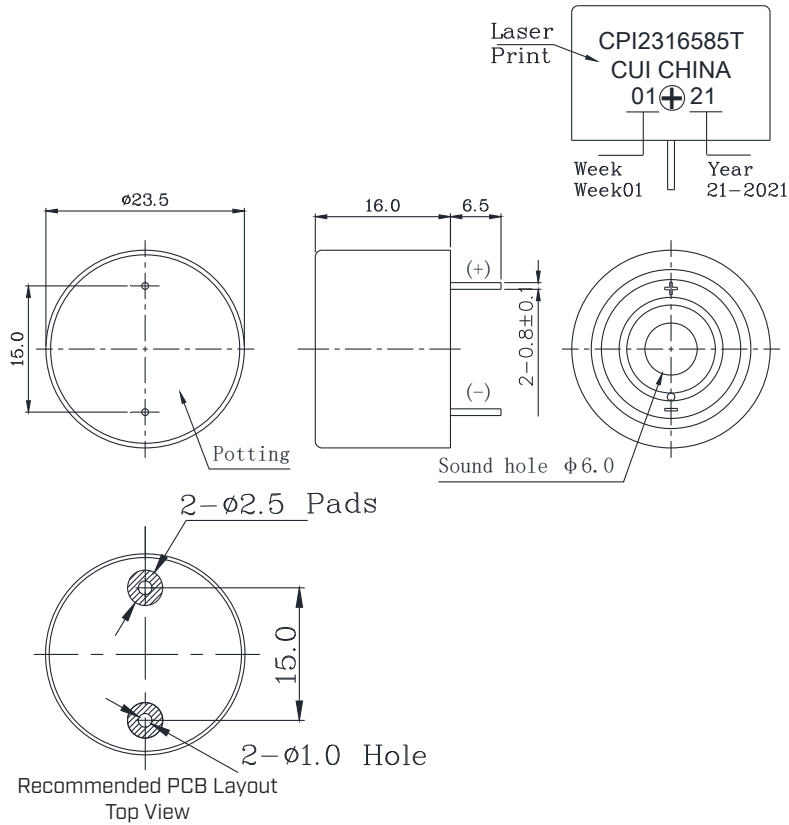

PERFORMANCE CURVES

Voltage vs. Sound Pressure Level
at 10 cm, 25°C

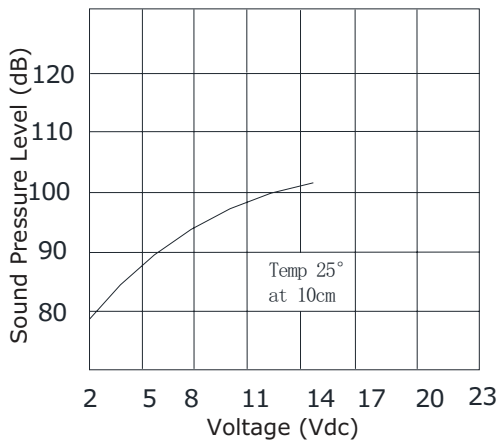

Voltage vs. Current Consumption
at 25°C

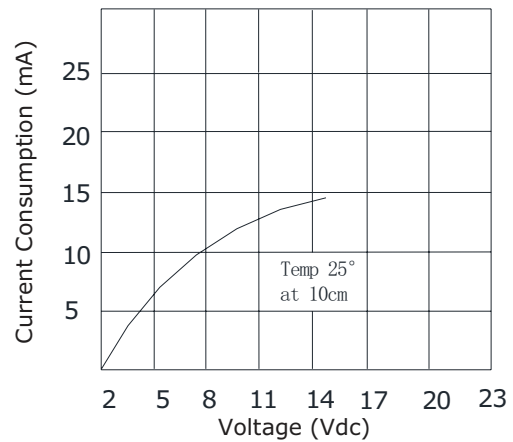

PACKAGING

units: mm

Tray Size: 315 x 170 x 28 mm
 Tray QTY: 50 pcs per tray
 Carton Size: 520 x 330 x 280 mm
 Carton QTY: 1,500 pcs per carton

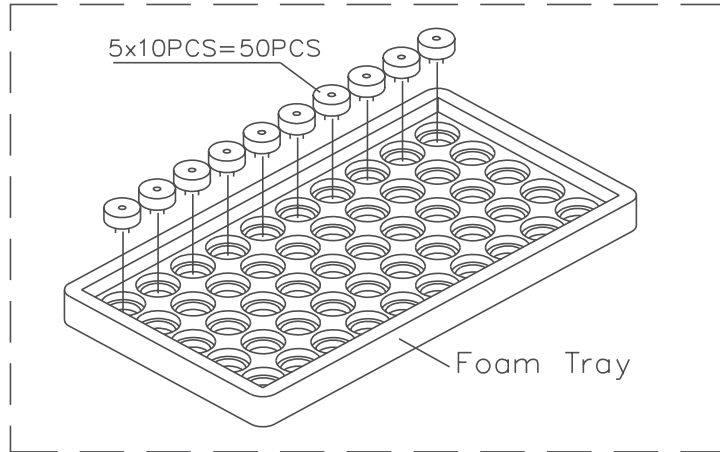

Lot No.	XXXXXXXXXX
Part No.	XXXXXXXXXX XXXXXXXXXX
Quantity.	XXXX Pcs
Date:	
WWYY	RoHs Compliant
MADE IN CHINA	
CUI DEVICES	

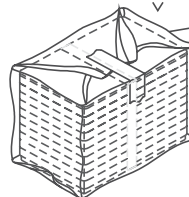
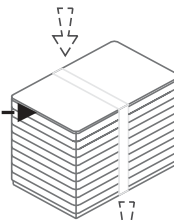

Plastic Bag
(10PCS Foam Tray)

Carton Box
(3PCS Plastic Bag)

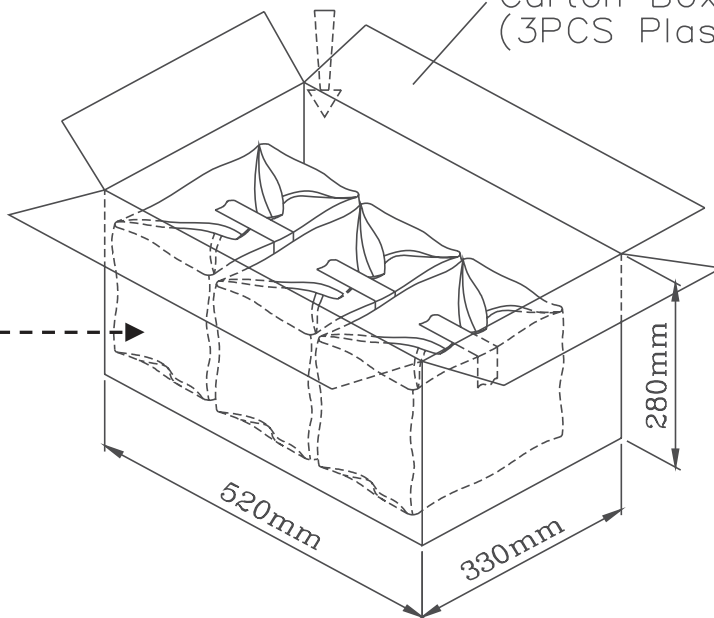

REVISION HISTORY

rev.	description	date
1.0	initial release	11/24/2021
1.01	logo, datasheet style update	08/05/2022

The revision history provided is for informational purposes only and is believed to be accurate.



CUI Devices offers a one (1) year limited warranty. Complete warranty information is listed on our website.

CUI Devices reserves the right to make changes to the product at any time without notice. Information provided by CUI Devices is believed to be accurate and reliable. However, no responsibility is assumed by CUI Devices for its use, nor for any infringements of patents or other rights of third parties which may result from its use.

CUI Devices products are not authorized or warranted for use as critical components in equipment that requires an extremely high level of reliability. A critical component is any component of a life support device or system whose failure to perform can be reasonably expected to cause the failure of the life support device or system, or to affect its safety or effectiveness.

cuidevices.com