



# EVQ7200A-L-00B

## 42V, 1.2A, 410kHz, Synchronous LED Driver Buck-Boost Mode Evaluation Board, AEC-Q100 Qualified

### DESCRIPTION

The EVQ7200A-L-00B is an evaluation board designed to demonstrate the capabilities of the MPQ7200A, a constant-current LED driver with integrated power MOSFETs. It offers a very compact solution to achieve 1.2A of continuous output current ( $I_{OUT}$ ), with excellent load and line regulation across a wide input supply range.

Constant frequency hysteretic control mode provides extremely fast transient response without loop compensation. The switching

frequency ( $f_{SW}$ ) is 410kHz in buck-boost mode for optimized efficiency and thermal performance.

The MPQ7200A is available in a QFN-19 (3mmx4mm) package with wettable flanks, and is available in AEC-Q100 Grade 1.

The EVQ7200A-L-00B is a fully assembled and tested buck-boost mode LED driver evaluation board. It generates an LED current up to 1.2A from a 6V to 20V input range.

### PERFORMANCE SUMMARY

Specifications are at  $T_A = 25^\circ\text{C}$ , unless otherwise noted.

Parameters	Conditions	Value
Input voltage ( $V_{IN}$ ) range		6V to 20V
Maximum output current ( $I_{OUT}$ )	$V_{IN} = 6\text{V to }20\text{V}$	1.2A
Typical efficiency	$V_{IN} = 13.5\text{V}$ , 4 LEDs, $I_{OUT} = 1.2\text{A}$	89.95%
Peak efficiency	$V_{IN} = 13.5\text{V}$ , 4 LEDs, $I_{OUT} = 0.75\text{A}$	91.06%
Switching frequency ( $f_{SW}$ )		410kHz

### EVALUATION BOARD

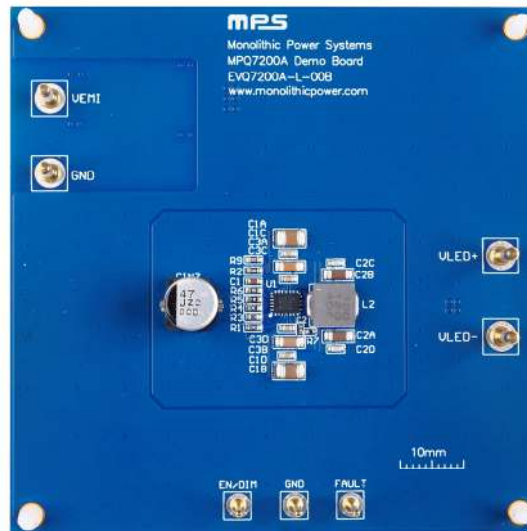

LxWxH (8.3cmx8.3cmx1.3cm)

Board Number	MPS IC Number
EVQ7200A-L-00B	MPQ7200AGLE-AEC1

## QUICK START GUIDE

1. Preset the power supply between 6V and 20V, then turn off the power supply (see Figure 1). Note that the input voltage ( $V_{EMI}$ ) plus output voltage ( $V_{OUT}$ ) should be below 40V.

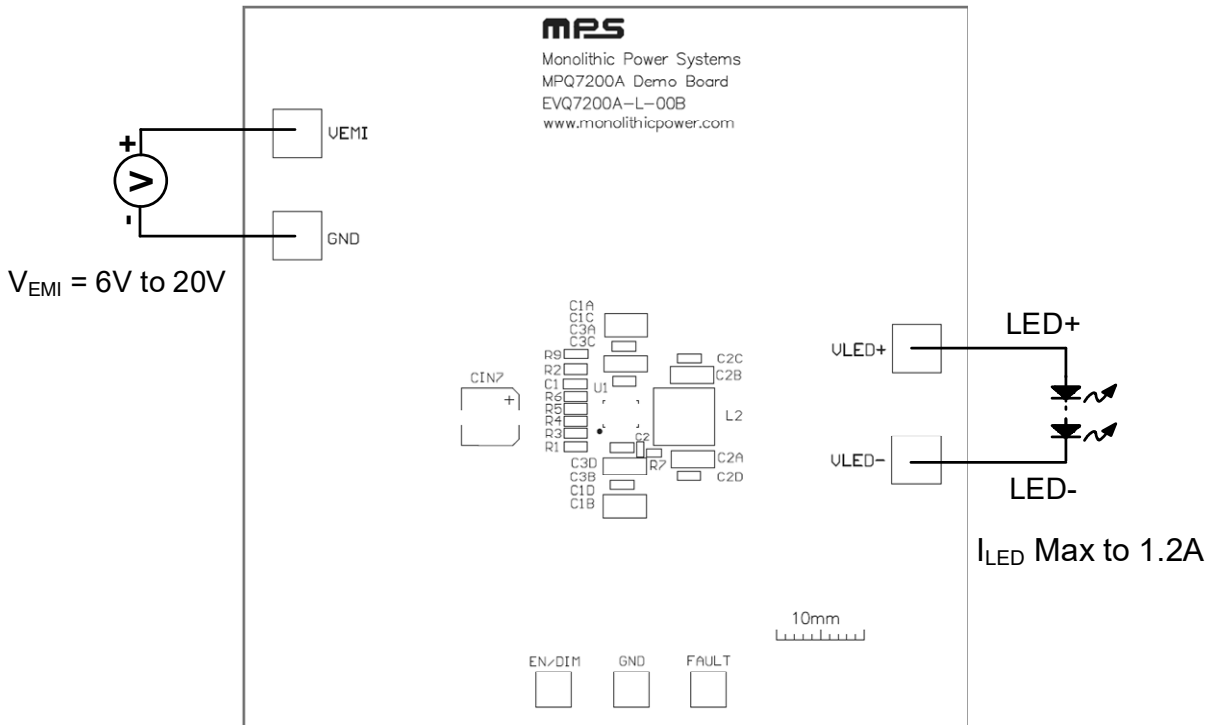

**Figure 1: Measurement Equipment Set-Up**

2. If longer cables (>0.5m total) are being used between the source and the evaluation board, install a damping capacitor at the input terminals. This is especially critical when  $V_{EMI}$  exceeds 24V.
3. Connect the power supply terminals to:
  - a. Positive (+): VEMI
  - b. Negative (-): GND
4. Connect the load terminals to:
  - a. Positive (+): VLED+
  - b. Negative (-): VLED-
5. After making the connections, turn on the power supply.
6. To use the enable (EN) function, apply a digital input to the EN/DIM pin. Drive EN above 2.5V to turn the regulator on; drive EN below 1V to turn it off.
7. When two-step dimming is inactive ( $R_{DUTY} = 4.87k\Omega$ ), an external 100Hz to 2kHz pulse-width modulation (PWM) waveform can be applied to the EN/DIM pin.
8. To initiate two-step dimming, use the EN/DIM pin. Table 1 on page 3 shows the proposed resistor (R3) in E96 series for different dimming duty cycles. When EN/DIM is high, the dimming duty cycle is 100%; when EN/DIM is low, the dimming duty cycle percentage varies.

**QUICK START GUIDE (continued)**
**Table 1: Two-Step Dimming Duty vs. R3**

Two-Step Dimming Duty	R3 (Ω)
15%	61900
14%	41200
13%	27400
12%	18200
11%	12100
10%	7870
Two-step dimming off	4870
9%	3090
8%	2050
7%	1370
6%	887
5%	576

9. The external resistor (R5) connected to the ISET pin sets the LED current ( $I_{LED}$ ). R5 can be calculated using Equation (1):

$$R5 = \frac{16}{I_{LED}(A)} (k\Omega) \quad (1)$$

To get better  $I_{LED}$  precision, Table 2 shows the recommended LED setting resistor values in buck-boost mode when  $I_{LED}$  is below 0.7A (see Figure 2).

**Table 2: Resistor Selection when  $I_{LED} \leq 700mA$  in Buck-Boost Mode**

$I_{LED}$ (A)	R5 (kΩ)
0.7	22.6
0.65	24.4
0.6	26.3
0.55	28.6
0.5	31.5
0.45	34.9
0.4	39.1

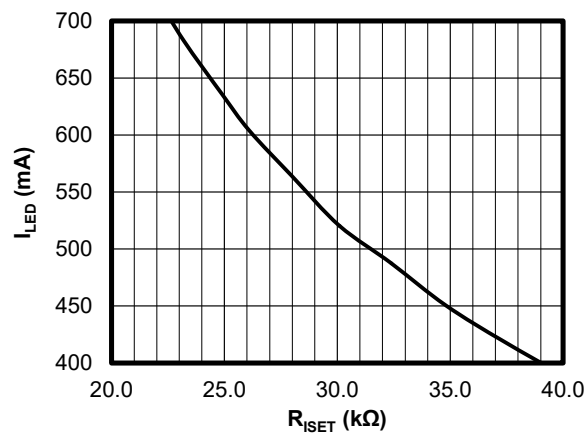
**Figure 2:  $I_{LED}$  vs.  $R_{ISET}$  when  $I_{LED} \leq 700mA$  in Buck-Boost Mode**

### EVALUATION BOARD SCHEMATIC

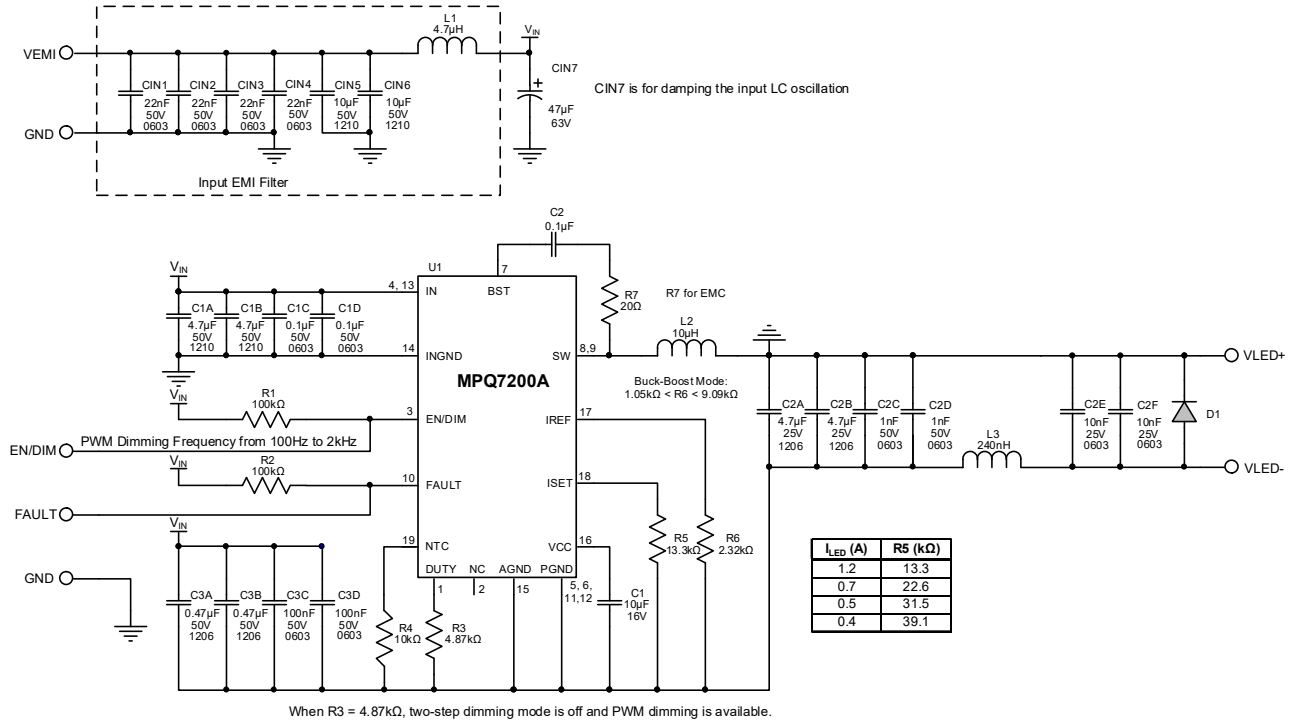

Figure 3: Evaluation Board Schematic

**EVQ7200A-L-00B BILL OF MATERIALS**

Qty	Ref	Value	Description	Package	Manufacturer	Manufacturer PN
1	L1	4.7 $\mu$ H	Inductor, 44.1m $\Omega$ DCR, 4.6A	SMD	Coilcraft	XAL4030-472MEB
1	L2	10 $\mu$ H	Inductor, 61m $\Omega$ DCR, 4A	SMD	Cyntec	VCMT063T-100MN5
1	L3	240nH	Inductor, 27m $\Omega$ DCR, 3.8A	SMD	Cyntec	VCUW20161B-R24MS5-89
4	CIN1, CIN2, CIN3, CIN4	22nF	Ceramic capacitor, 50V, X7R	0603	TDK	C1608X7R1H223K
2	CIN5, CIN6	10 $\mu$ F	Ceramic capacitor, 50V, X7R	1210	Murata	GRM32ER71H106KA8
1	CIN7	47 $\mu$ F	Electrolytic capacitor, 63V	SMD	Panasonic	EEHZC1J470P
2	C1A, C1B	4.7 $\mu$ F	Ceramic capacitor, 50V, X7R	1210	Murata	GRM32ER71H475KA8
4	C1C, C1D, C3C, C3D	0.1 $\mu$ F	Ceramic capacitor, 50V, X7R	0603	Murata	GRM188R71H104KA93D
2	C2A, C2B	4.7 $\mu$ F	Ceramic capacitor, 25V, X7R	1206	TDK	C3216X7R1E475M
2	C3A, C3B	0.47 $\mu$ F	Ceramic capacitor, 50V, X7R	1206	TDK	C3216X7R1H474K
2	C2C, C2D	1nF	Ceramic capacitor, 50V, C0G	0603	Murata	GRM1885C1H02JAC
2	C2E, C2F	10nF	Ceramic capacitor, 25V, X7R	0603	Würth	885012206065
1	C1	10 $\mu$ F	Ceramic capacitor, 10V, X7R	0603	Murata	GRM188Z71A106KA73D
1	C2	0.1 $\mu$ F	Ceramic capacitor, 16V, X7R	0603	Murata	GRM188R71C104KA01D
2	R1, R2	100k $\Omega$	Film resistor, 5%	0603	Yageo	RC0603JR-07100KL
1	R9	10 $\Omega$	Film resistor, 1%	0604	Yageo	RC0603FR-0710RL
1	R4	10k $\Omega$	Film resistor, 1%	0603	Yageo	RC0603FR-0710KL
1	R7	20 $\Omega$	Film resistor, 1%	0402	Yageo	RC0402FR-0720RL
1	R5	13.3k $\Omega$	Film resistor, 1%	0603	Yageo	RC0603FR-0713K3L
1	R6	2.32k $\Omega$	Film resistor, 1%	0603	Yageo	RC0603FR-072K32L
1	R3	4.87k $\Omega$	Film resistor, 1%	0603	Yageo	RC0603FR-074K87L
1	D1	40V	Schottky diode, 1A	SMA	Diodes, Inc.	B140
4	VEMI, GND, VLED+, VLED-	2mm	Golden pin	DIP	Custom	
4	EN, GND, DIM, FAULT	1mm	Golden pin	DIP	Custom	
1	U1	MPQ7200A	Buck-boost regulator, AEC-Q100	QFN-19 (3mmx4mm)	MPS	MPQ7200AGLE-AEC1

## EVB TEST RESULTS

Performance curves and waveforms are tested on the evaluation board,  $V_{IN} = 13.5V$ , 4 LEDs in series ( $V_{LED} = 12V$ ),  $f_{SW} = 410kHz$ ,  $L = 10\mu H$ ,  $T_A = 25^\circ C$ , unless otherwise noted.

### CISPR25 Class 5 Peak Conducted Emissions

150kHz to 108MHz

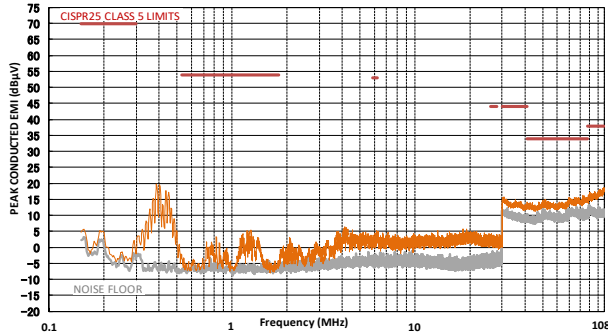

### CISPR25 Class 5 Average Conducted Emissions

150kHz to 108MHz

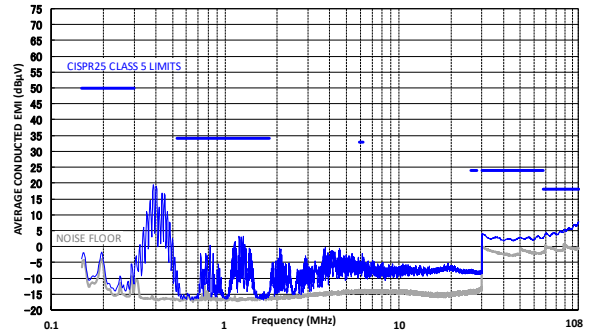

### CISPR25 Class 5 Peak Radiated Emissions

150kHz to 30MHz

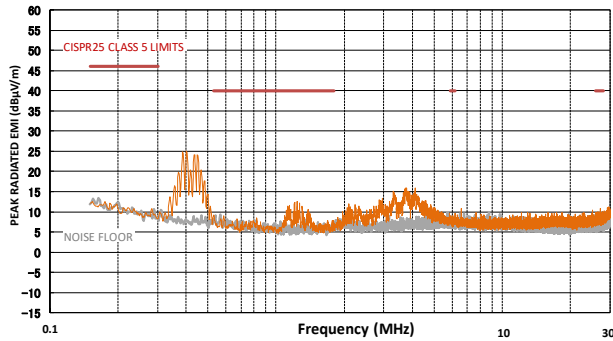

### CISPR25 Class 5 Average Radiated Emissions

150kHz to 30MHz

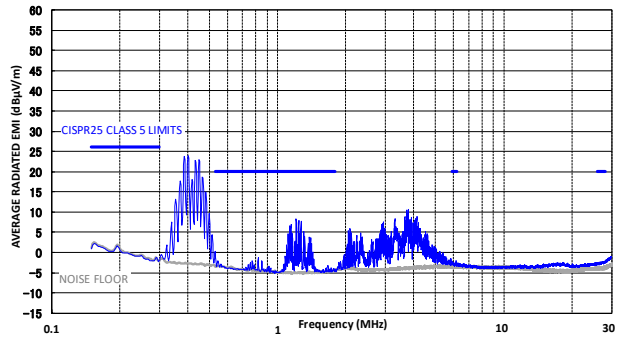

### CISPR25 Class 5 Peak Radiated Emissions

Horizontal, 30MHz to 200MHz

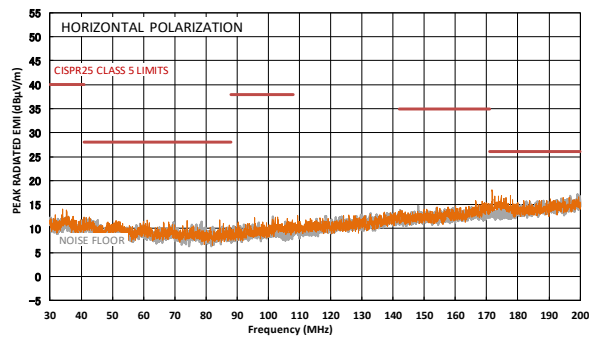

### CISPR25 Class 5 Average Radiated Emissions

Horizontal, 30MHz to 200MHz

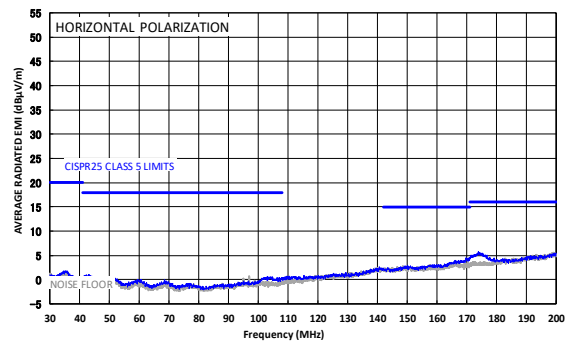

## EVB TEST RESULTS *(continued)*

Performance curves and waveforms are tested on the evaluation board,  $V_{IN} = 13.5V$ , 4 LEDs in series ( $V_{LED} = 12V$ ),  $f_{SW} = 410kHz$ ,  $L = 10\mu H$ ,  $T_A = 25^\circ C$ , unless otherwise noted.

### CISPR25 Class 5 Peak Radiated Emissions

Vertical, 30MHz to 200MHz

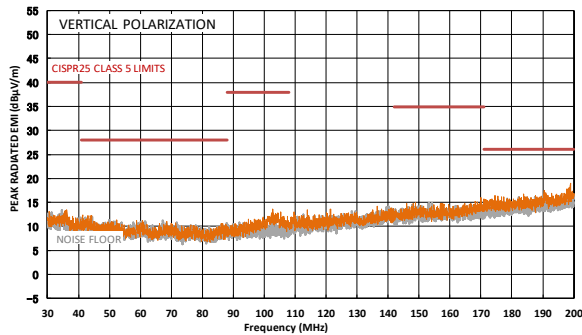

### CISPR25 Class 5 Average Radiated Emissions

Vertical, 30MHz to 200MHz

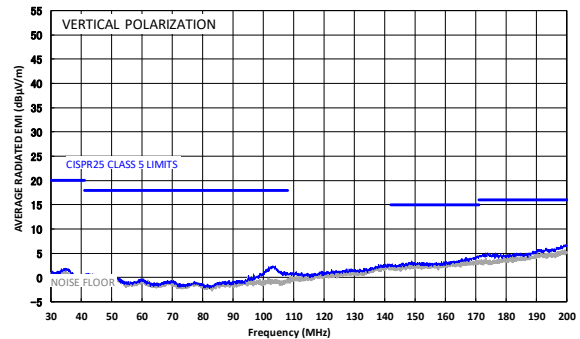

### CISPR25 Class 5 Peak Radiated Emissions

Horizontal, 200MHz to 1GHz

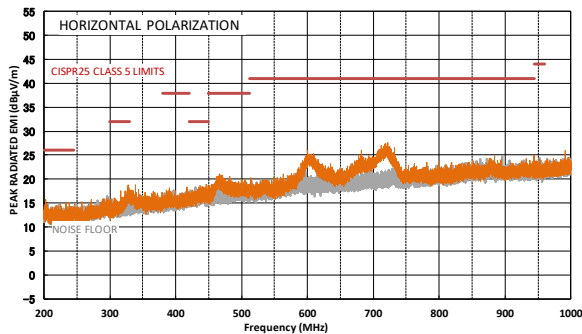

### CISPR25 Class 5 Average Radiated Emissions

Horizontal, 200MHz to 1GHz

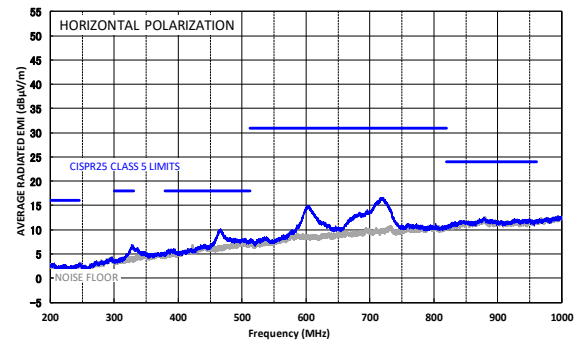

### CISPR25 Class 5 Peak Radiated Emissions

Vertical, 200MHz to 1GHz

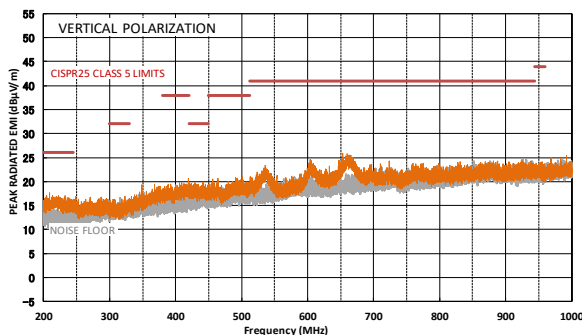

### CISPR25 Class 5 Average Radiated Emissions

Vertical, 200MHz to 1GHz

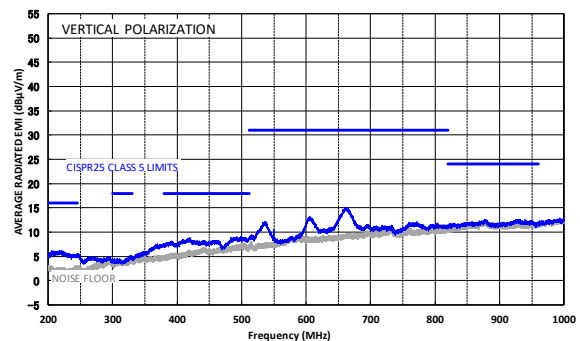

## EVB TEST RESULTS (continued)

Performance curves and waveforms are tested on the evaluation board,  $V_{IN} = 13.5V$ , 4 LEDs in series ( $V_{LED} = 12V$ ),  $f_{SW} = 410kHz$ ,  $L = 10\mu H$ ,  $T_A = 25^\circ C$ , unless otherwise noted. <sup>(1)</sup>

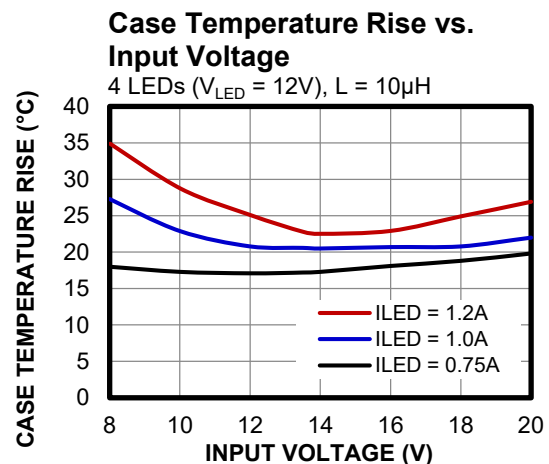
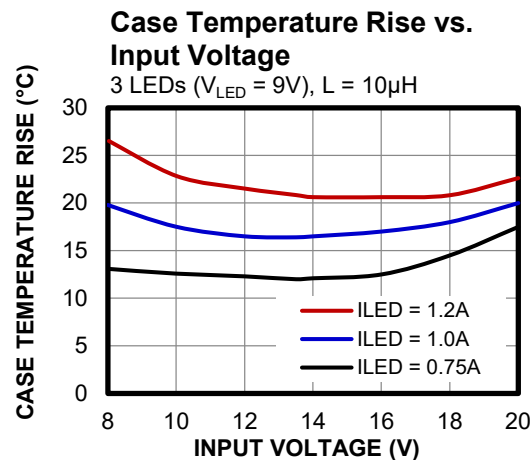
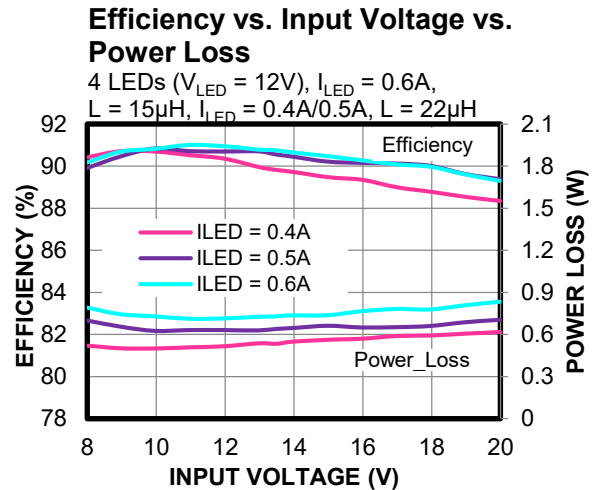
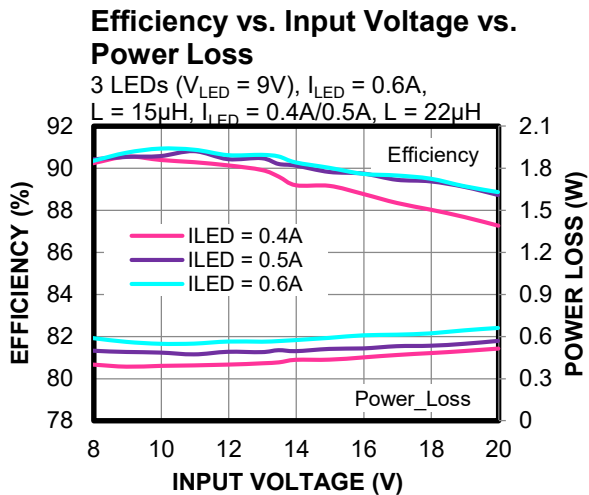
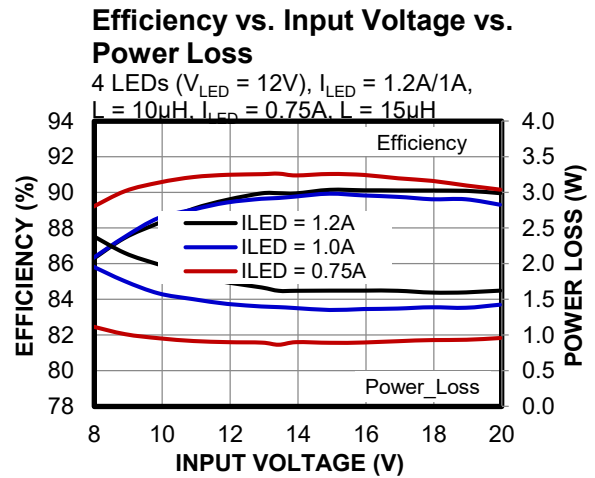
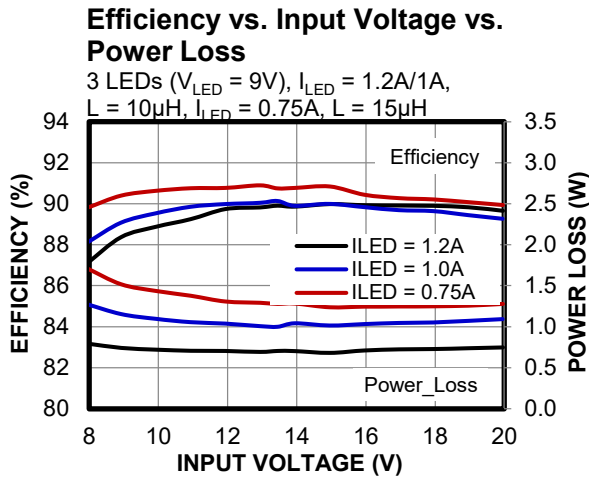

**Note:**

1) The inductor details about the efficiency curves follow:  $L = 15\mu H$  (XAL5050-153MEB),  $L = 22\mu H$  (XAL5050-223MEB).



## EVB TEST RESULTS (continued)

Performance curves and waveforms are tested on the evaluation board,  $V_{IN} = 13.5V$ , 4 LEDs in series ( $V_{LED} = 12V$ ),  $f_{sw} = 410kHz$ ,  $L = 10\mu H$ ,  $T_A = 25^\circ C$ , unless otherwise noted.

### Steady State

$I_{LED} = 1.2A$

CH3:  $I_{LED}$   
CH2:  $V_{LED+} - V_{LED-}$   
CH4:  $I_L$   
CH1:  $V_{sw}$

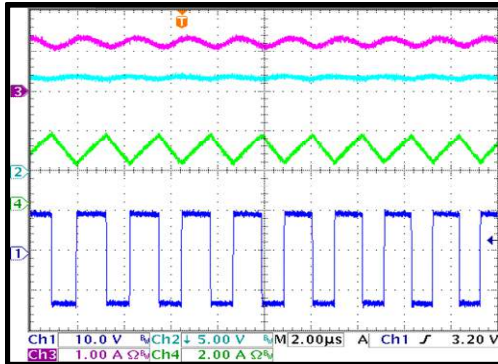

### Start-Up through VIN

$I_{LED} = 1.2A$

R1:  $V_{IN}$   
10V/div.  
CH2:  $V_{LED+} - V_{LED-}$   
CH3:  $I_{LED}$   
CH4:  $I_L$   
CH1:  $V_{sw}$

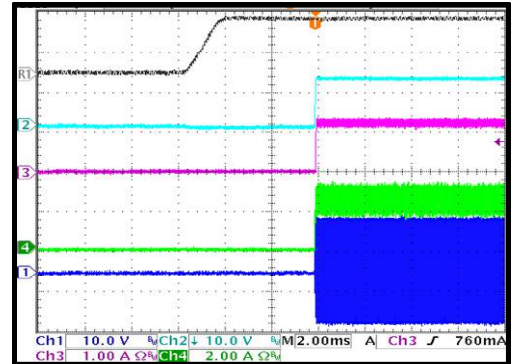

### Shutdown through VIN

$I_{LED} = 1.2A$

R1:  $V_{IN}$   
10V/div.  
CH2:  $V_{LED+} - V_{LED-}$   
CH3:  $I_{LED}$   
CH4:  $I_L$   
CH1:  $V_{sw}$

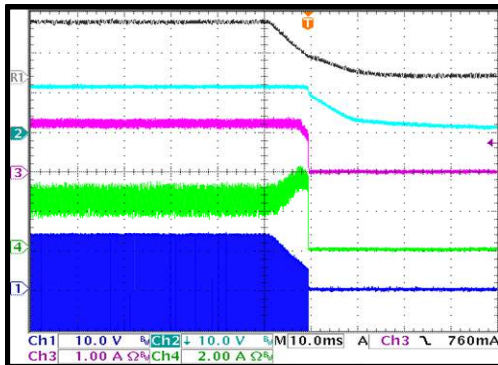

### Start-Up through EN

$I_{LED} = 1.2A$

R1:  $V_{ENDIM}$   
2V/div.  
CH2:  $V_{LED+} - V_{LED-}$   
CH3:  $I_{LED}$   
CH4:  $I_L$   
CH1:  $V_{sw}$

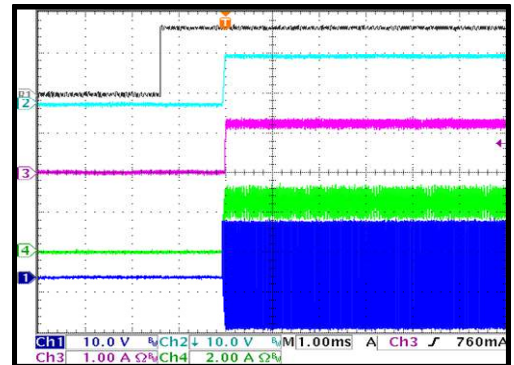

### Shutdown through EN

$I_{LED} = 1.2A$

R1:  $V_{ENDIM}$   
2V/div.  
CH2:  $V_{LED+} - V_{LED-}$   
CH3:  $I_{LED}$   
CH4:  $I_L$   
CH1:  $V_{sw}$

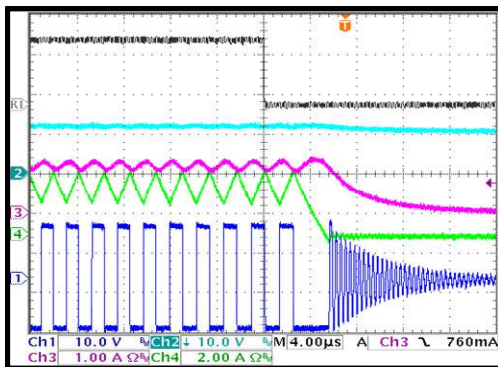

### PWM Dimming Steady State

Dimming frequency = 100Hz

CH2:  $V_{ENDIM}$   
CH3:  $I_{LED}$   
CH4:  $I_L$   
CH1:  $V_{sw}$

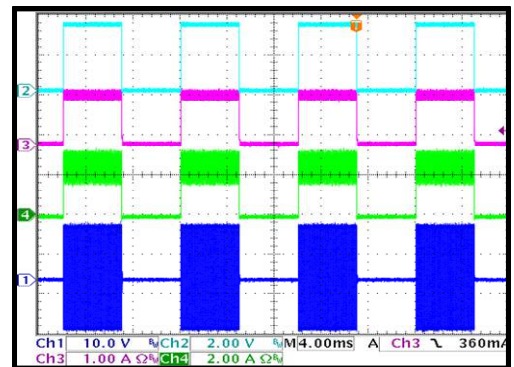

## EVB TEST RESULTS *(continued)*

Performance curves and waveforms are tested on the evaluation board,  $V_{IN} = 13.5V$ , 4 LEDs in series ( $V_{LED} = 12V$ ),  $f_{SW} = 410kHz$ ,  $L = 10\mu H$ ,  $T_A = 25^\circ C$ , unless otherwise noted.

### PWM Dimming Steady State

Dimming frequency = 2KHz

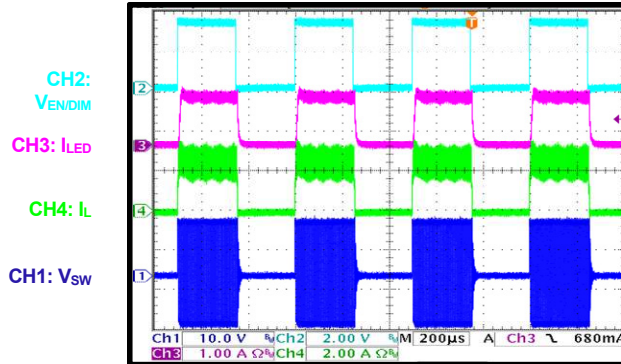

### PWM Dimming

Start-up through VIN

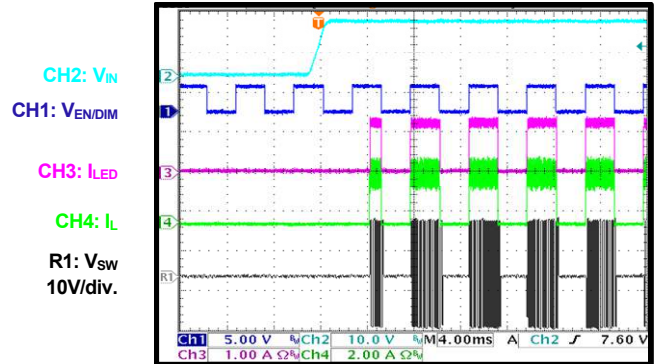

### PWM Dimming

Shutdown through VIN

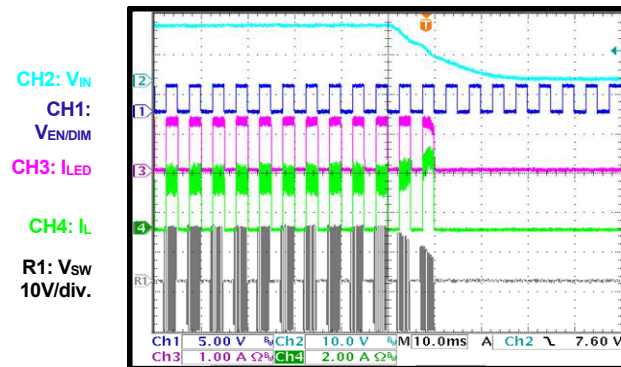

### Two-Step Dimming

Steady state

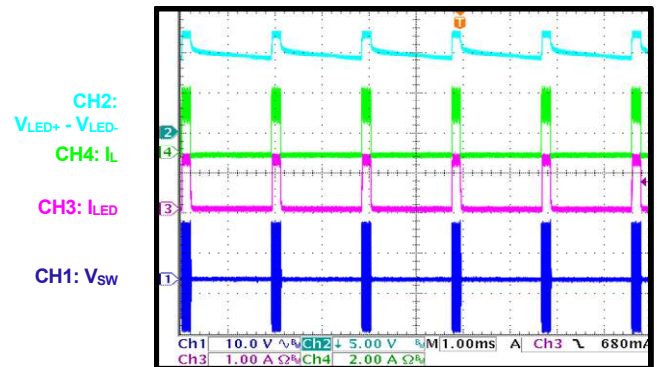

### Two-Step Dimming

Start-up through VIN

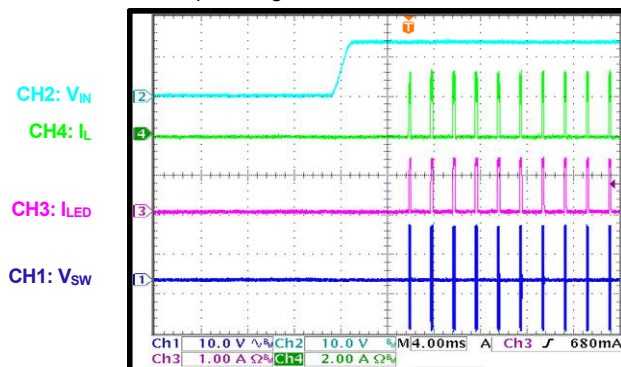

### Two-Step Dimming

Shutdown through VIN

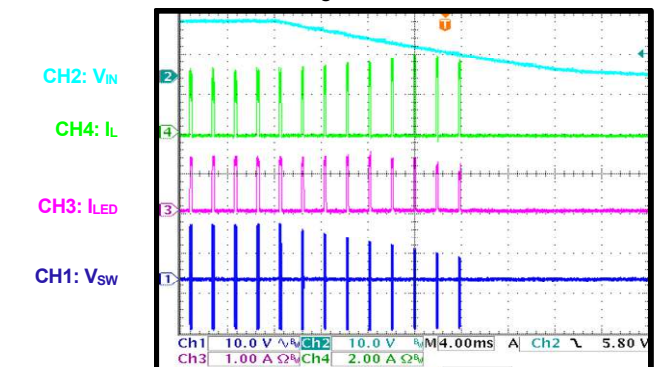

## EVB TEST RESULTS (continued)

Performance curves and waveforms are tested on the evaluation board,  $V_{IN} = 13.5V$ , 4 LEDs in series ( $V_{LED} = 12V$ ),  $f_{SW} = 410kHz$ ,  $L = 10\mu H$ ,  $T_A = 25^\circ C$ , unless otherwise noted.

### No Dimming

LED open during VIN start-up

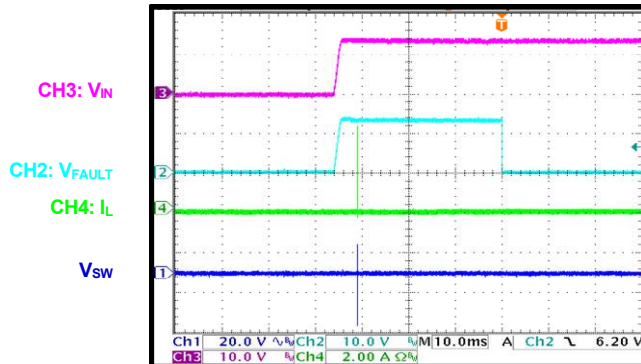

### No Dimming

LED open entry

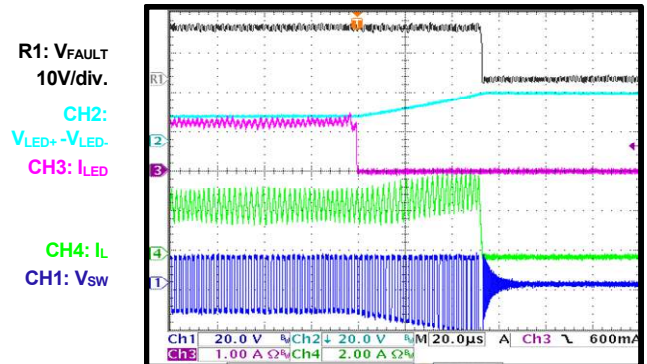

### PWM Dimming

LED open during VIN start-up

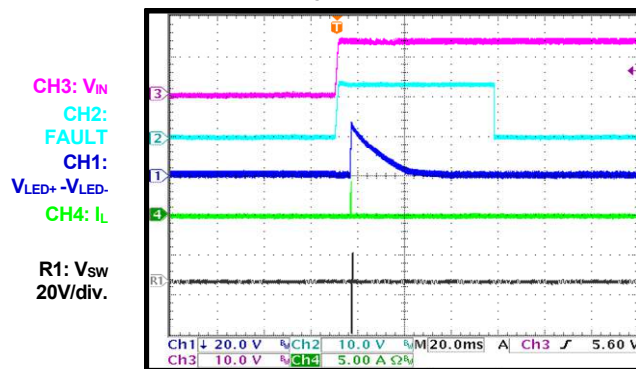

### PWM Dimming

LED open entry

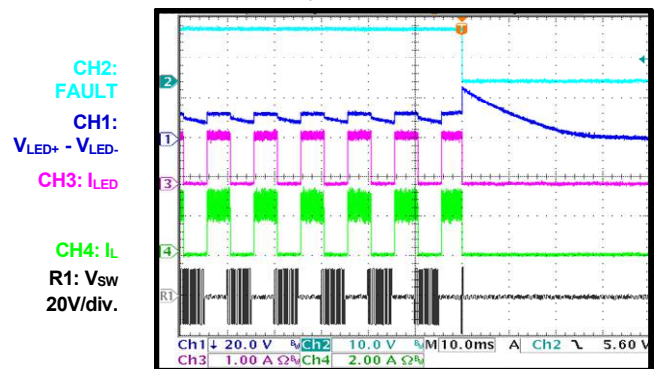

### Two-Step Dimming

LED open during VIN start-up

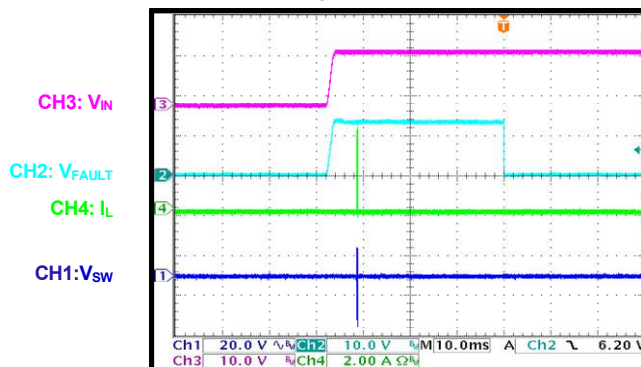

### Two-Step Dimming

LED open entry

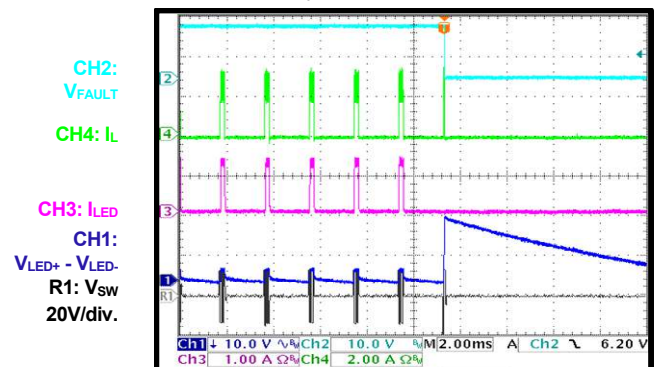

## EVB TEST RESULTS *(continued)*

Performance curves and waveforms are tested on the evaluation board,  $V_{IN} = 13.5V$ , 4 LEDs in series ( $V_{LED} = 12V$ ),  $f_{SW} = 410kHz$ ,  $L = 10\mu H$ ,  $T_A = 25^\circ C$ , unless otherwise noted.

### No Dimming

LED+ short to LED- during VIN start-up

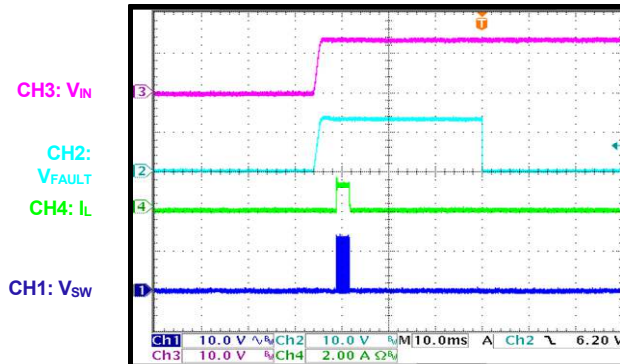

### No Dimming

LED+ short to LED- entry

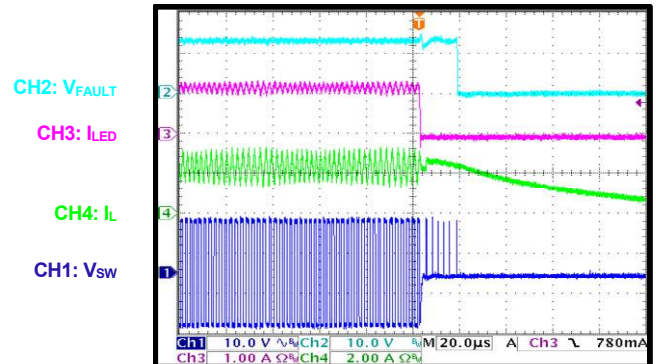

### PWM Dimming

LED+ short to LED- during VIN start-up

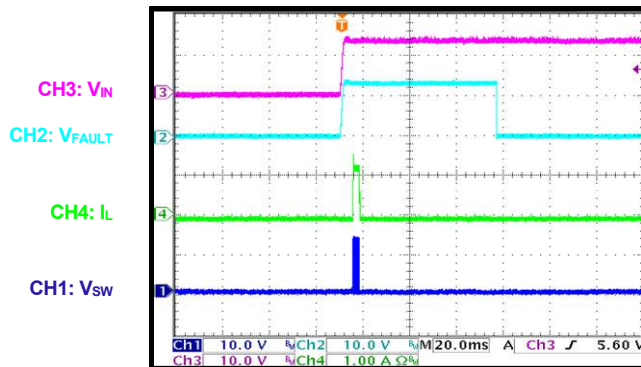

### PWM Dimming

LED+ short to LED- entry

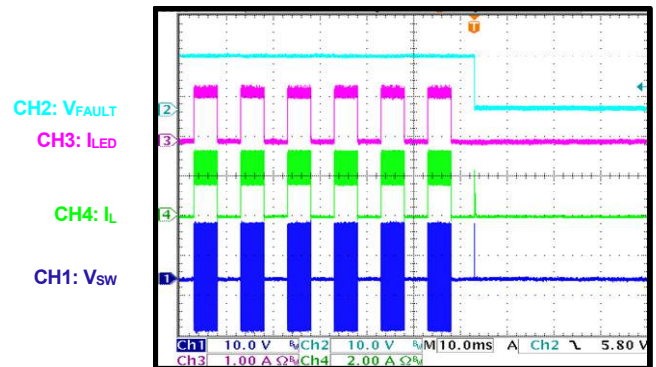

### Two-Step Dimming

LED+ short to LED- during VIN start-up

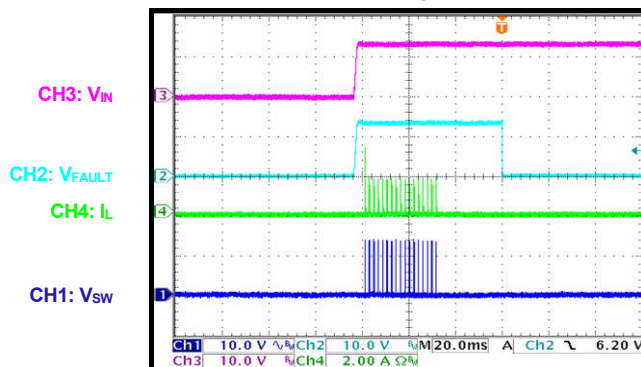

### Two-Step Dimming

LED+ short to LED- entry

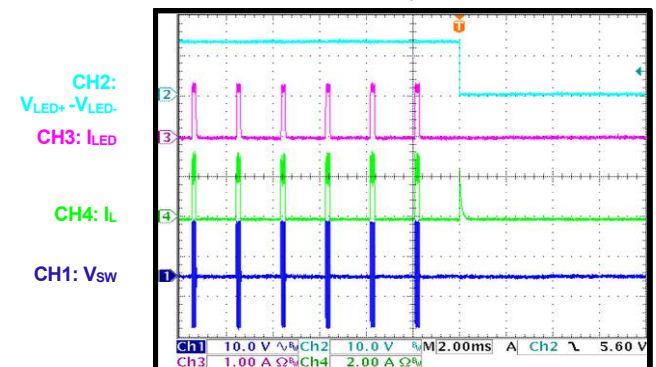

## EVB TEST RESULTS (continued)

Performance curves and waveforms are tested on the evaluation board,  $V_{IN} = 13.5V$ , 4 LEDs in series ( $V_{LED} = 12V$ ),  $f_{SW} = 410kHz$ ,  $L = 10\mu H$ ,  $T_A = 25^\circ C$ , unless otherwise noted.

**I<sub>REF</sub> Short before VIN Start-Up**

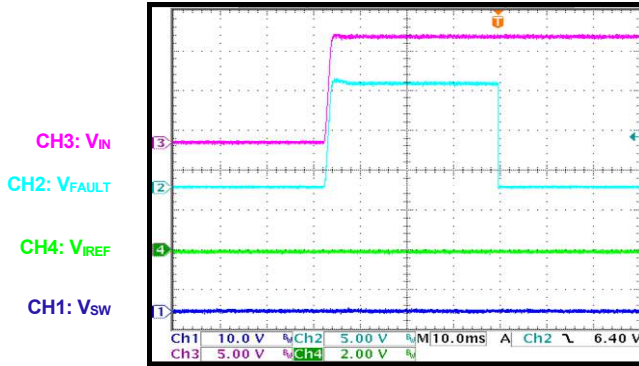

**I<sub>REF</sub> Open before VIN Start-Up**

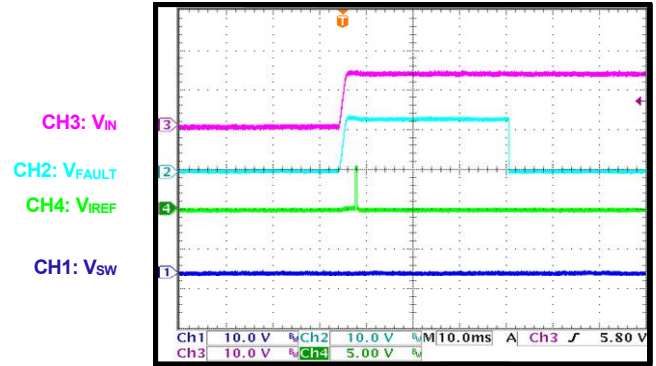

**I<sub>REF</sub> Short after VIN Start-Up**

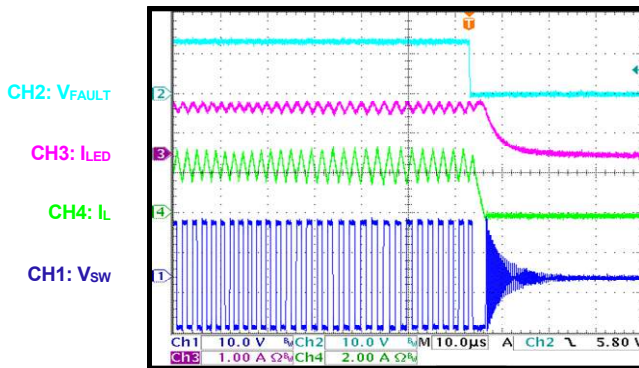

**I<sub>REF</sub> Open after VIN Start-Up**

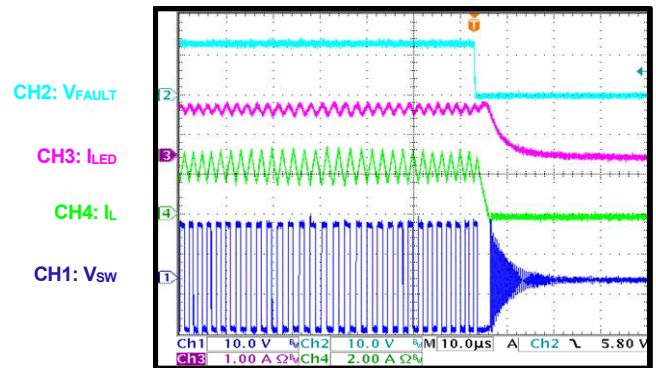

**I<sub>REF</sub> Short after VIN Start-Up  
PWM dimming**

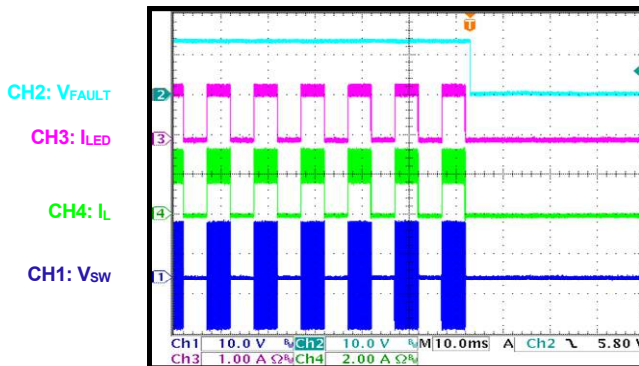

**I<sub>REF</sub> Open after VIN Start-Up  
PWM dimming**

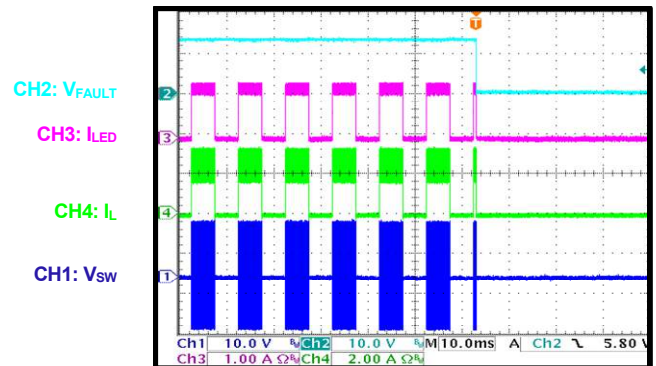

## EVB TEST RESULTS (continued)

Performance curves and waveforms are tested on the evaluation board,  $V_{IN} = 13.5V$ , 4 LEDs in series ( $V_{LED} = 12V$ ),  $f_{SW} = 410kHz$ ,  $L = 10\mu H$ ,  $T_A = 25^\circ C$ , unless otherwise noted.

**I<sub>SET</sub> Short before VIN Start-Up**

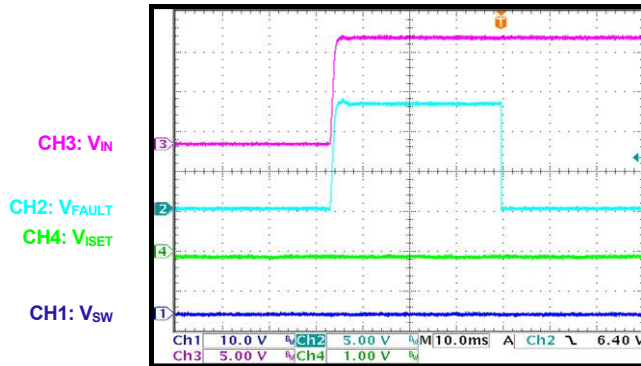

**I<sub>SET</sub> Open before VIN Start-Up**

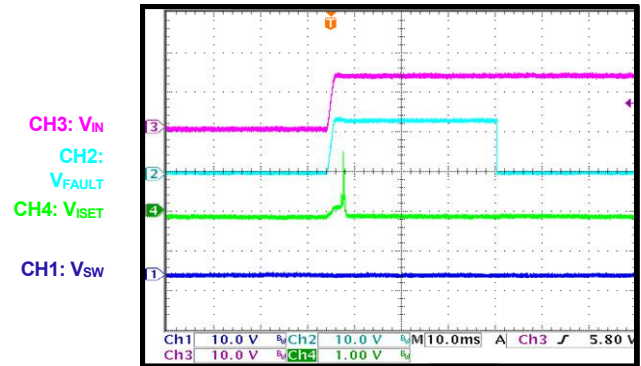

**I<sub>SET</sub> Short after VIN Start-Up**

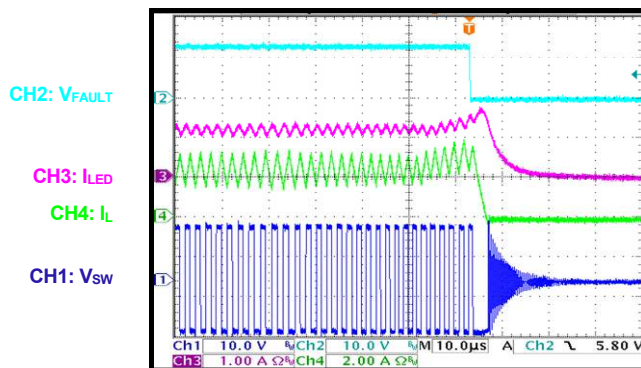

**I<sub>SET</sub> Open after VIN Start-Up**

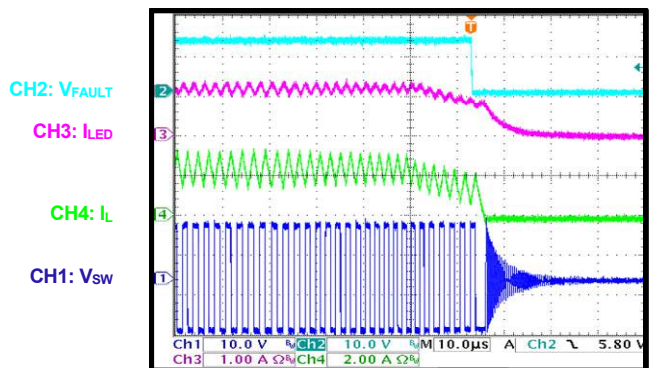

**I<sub>SET</sub> Short after VIN Start-Up  
PWM dimming**

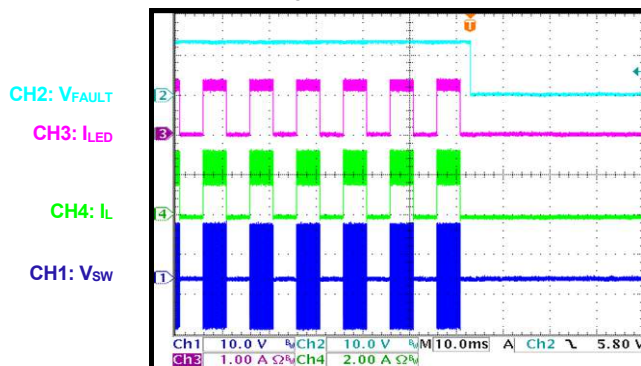

**I<sub>SET</sub> Open after VIN Start-Up  
PWM dimming**

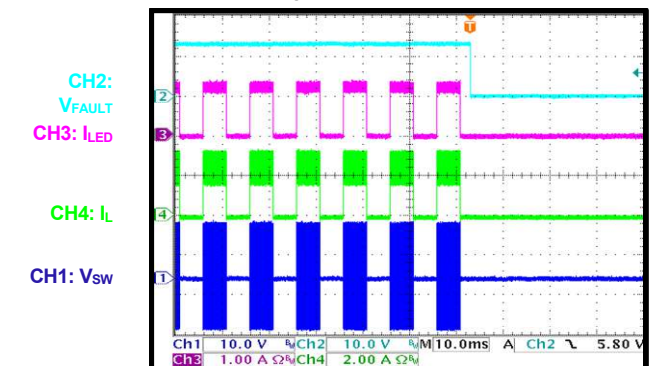

## EVB TEST RESULTS (continued)

Performance curves and waveforms are tested on the evaluation board,  $V_{IN} = 13.5V$ , 4 LEDs in series ( $V_{LED} = 12V$ ),  $f_{SW} = 410kHz$ ,  $L = 10\mu H$ ,  $T_A = 25^\circ C$ , unless otherwise noted.

### $I_{DUTY}$ Short before VIN Start-Up

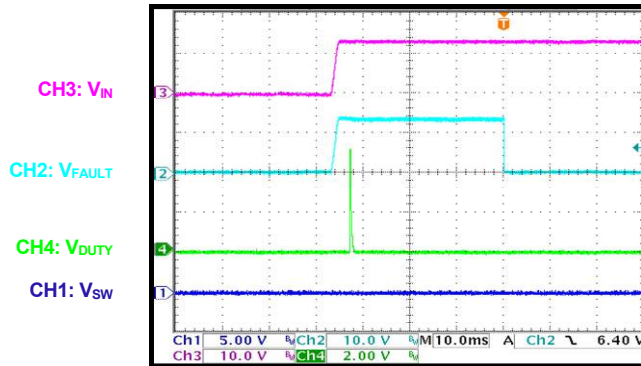

### $I_{DUTY}$ Open before VIN Start-Up

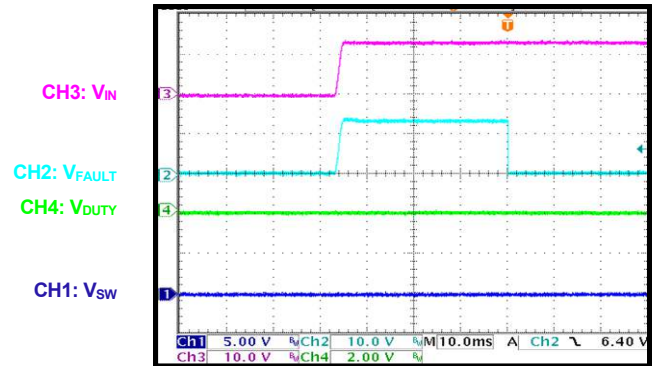

### FAULT Short during VIN Start-Up

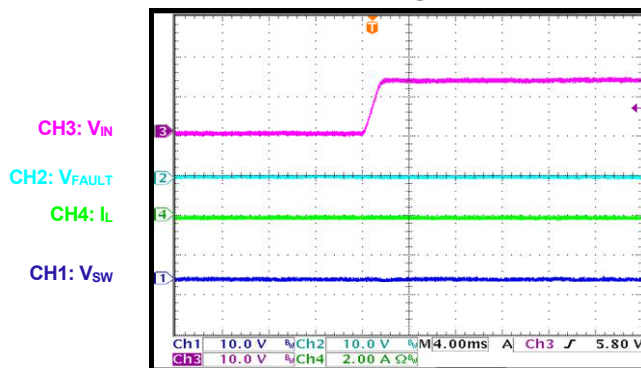

### FAULT Short after VIN Start-Up

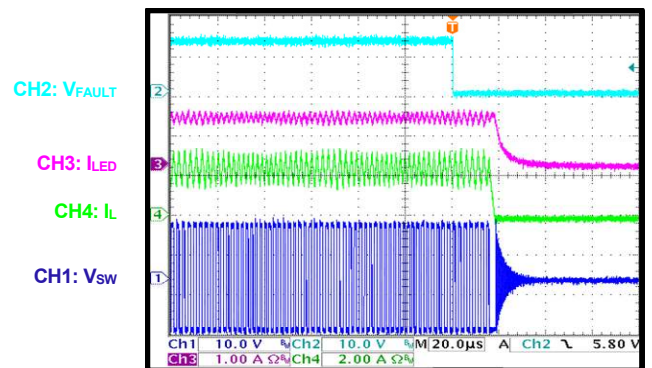

### False Mode Detection during VIN Start-Up

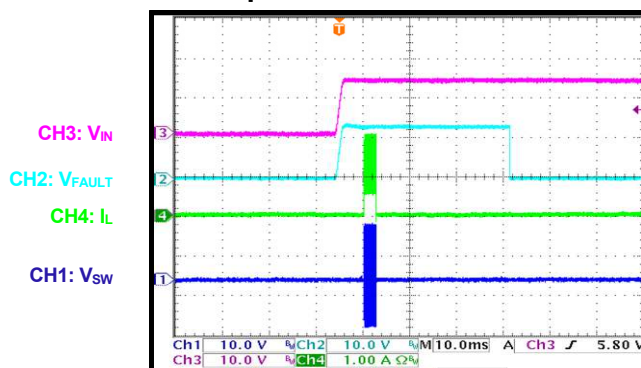

## PCB LAYOUT

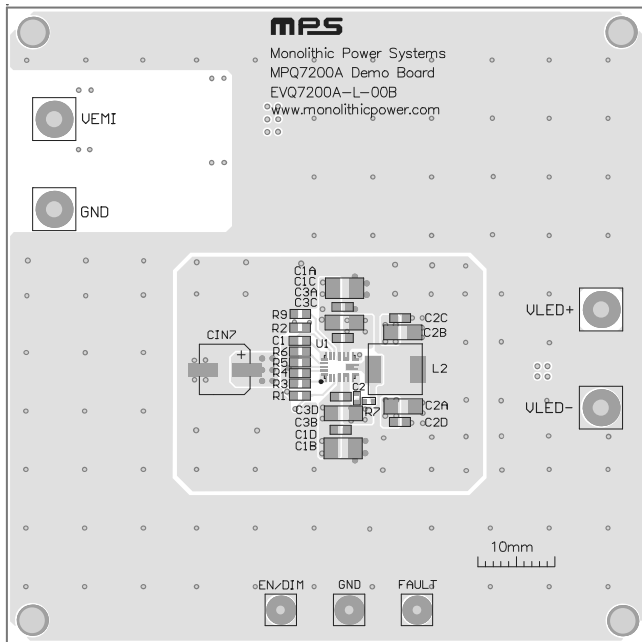

Figure 4: Top Silk and Top Layer

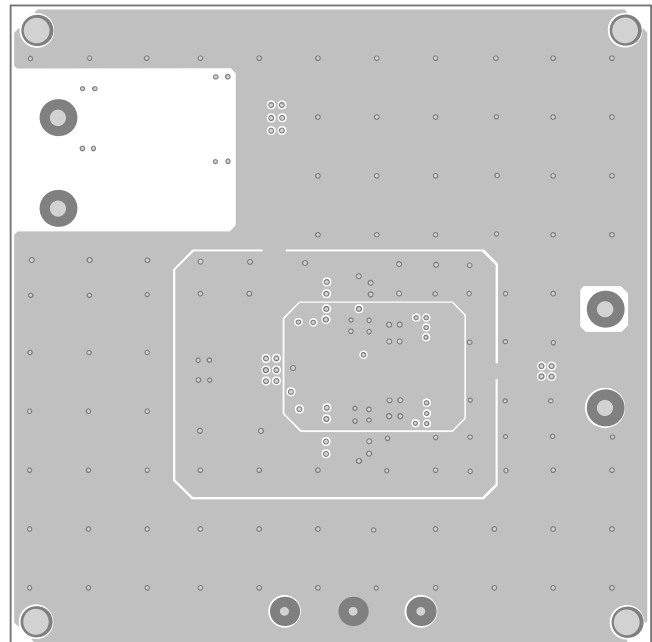

Figure 5: Mid-Layer 1

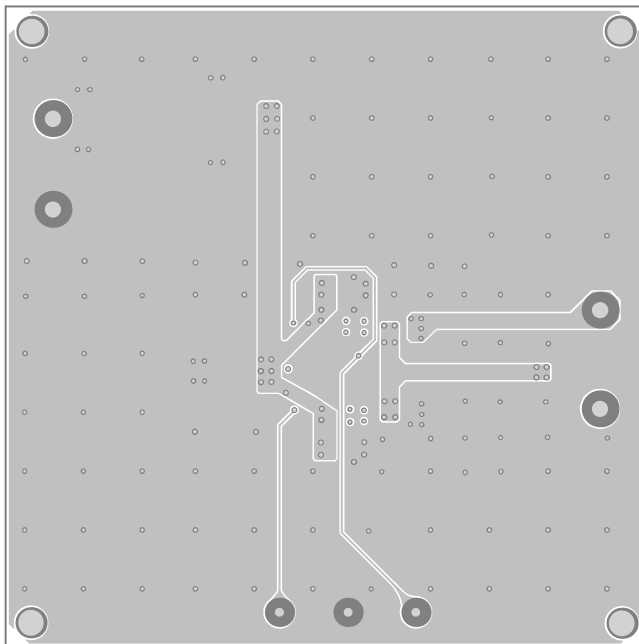

Figure 6: Mid-Layer 2

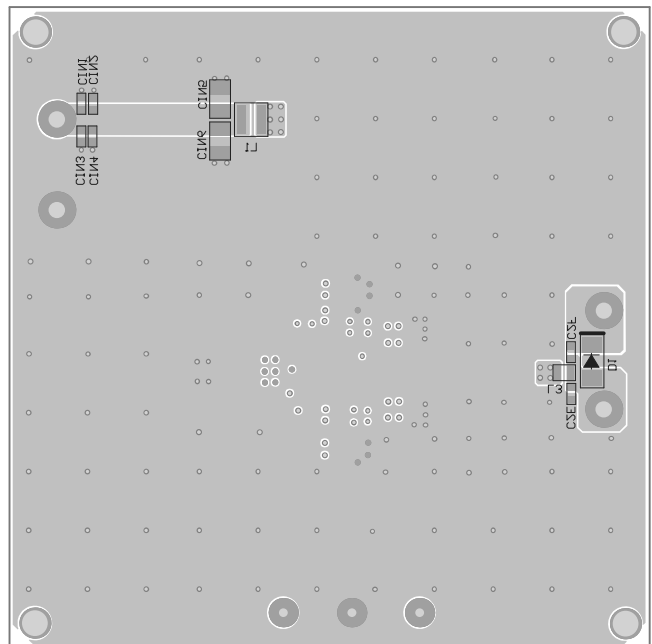

Figure 7: Bottom Layer and Bottom Silk



## REVISION HISTORY

Revision #	Revision Date	Description	Pages Updated
1.0	1/26/2022	Initial Release	-

**Notice:** The information in this document is subject to change without notice. Please contact MPS for current specifications. Users should warrant and guarantee that third-party Intellectual Property rights are not infringed upon when integrating MPS products into any application. MPS will not assume any legal responsibility for any said applications.