

### FEATURES

- Full-featured evaluation board for the AD7763 EVAL-CED1Z compatible**
- On-board 4.096V reference**
- PC software for control and data analysis for use with EVAL-CED1Z**
- Filter Programmability – Load custom filter to AD7763**

### EVALUATION BOARD DESCRIPTION

This data sheet describes the evaluation board for the AD7763  $\Sigma$ - $\Delta$  ADC. The AD7763 is a 24-bit ADC that combines wide input bandwidth and high speed with the benefits of  $\Sigma$ - $\Delta$  conversion with a performance of 109dB Dynamic Range at 625ksps, making it ideal for high-speed data acquisition.

The AD7760/2 are other devices in the family which operate with parallel data interfaces. The AD7760 offers 2.5MHz output data rates with dynamic range of 100dB. The AD7762 is the parallel version of the AD7763 with a maximum output data rate of 625 kHz.

Complete specifications for the AD7763 devices are available in the AD7763 data sheets available from Analog Devices, Inc., and should be consulted in conjunction with this data sheet when using the evaluation board.

The evaluation software is available to download from the AD7763 product pages. This includes both the Labview source code and the FPGA interfacing code, which is written for the FPGA on the acquisition board – EVAL-CED1Z.

The AD7763 interfacing signals are created by the EVAL-CED1Z board which should be used in conjunction with EVAL-AD7763EDZ board to enable data acquisition via the provided software and USB link. The EVAL-AD7763EDZ board itself includes all routing required for evaluating the AD7763 device.

The MCLK signal for the main device is generated by the EVAL-CED1Z board. The user can also choose if required, to drive the AD7763 with an external clock source by inserting the 0  $\Omega$  (R10) which links the SMB marked “MCLK” through the a clock buffer to the MCLK pin of the device.

The AD7763 evaluation board connects through the 34 pin connector to the EVAL-CED1Z board header (J12) marked “SPORT INTERFACE”. The combination of the EVAL-AD7763EDZ board and EVAL-CED1Z board allied with the EVAL-AD7763EDZ software allows the user to upload samples taken by the AD7763 device onto a PC showing the waveform being sampled, as well as allowing the data to be shown in histogram or FFT format. The EVAL-AD7763EDZ can also be used on a standalone basis (without EVAL-CED1Z); however, in this case the user must provide the required interface and acquisition requirements.

### CONTENTS OF EVALUATION KIT

- AD7763 evaluation board (EVAL-AD7763EDZ)
- EVAL-AD7763\_2EDZ evaluation software CD—software and drivers

### EVALUATION BOARD BLOCK DIAGRAM

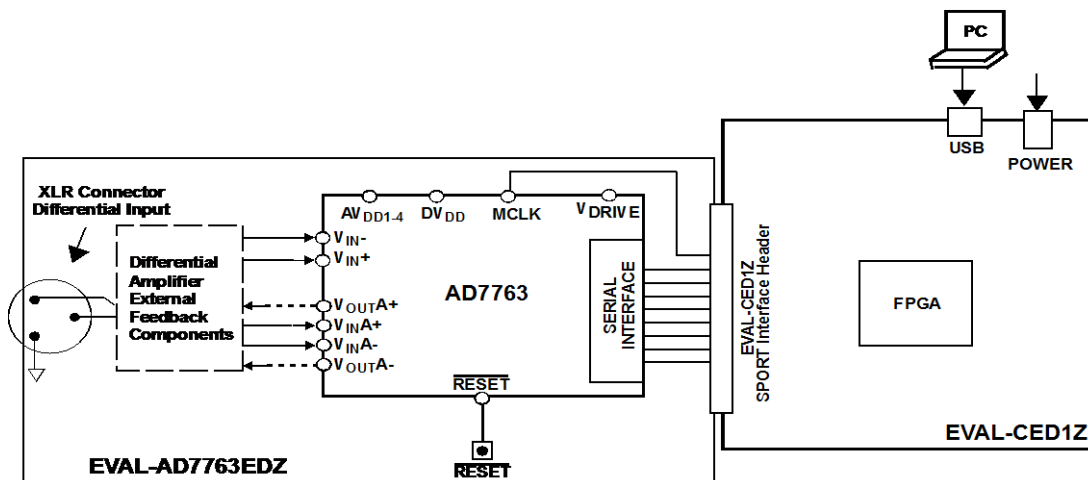

Figure 1.

Rev. PrA

Information furnished by Analog Devices is believed to be accurate and reliable. However, no responsibility is assumed by Analog Devices for its use, nor for any infringements of patents or other rights of third parties that may result from its use. Specifications subject to change without notice. No license is granted by implication or otherwise under any patent or patent rights of Analog Devices. Trademarks and registered trademarks are the property of their respective owners.

**TABLE OF CONTENTS**

Features .....	1	Installing the Software .....	5
Evaluation Board Description.....	1	Using the evaluation System .....	7
Contents of Evaluation Kit.....	1	Hardware connections.....	7
Evaluation Board Block Diagram .....	1	Software Instructions for Normal Use.....	8
Revision History .....	2	Downloading a User-Defined Filter .....	10
Hardware Description.....	3	Writing to Gain, Offset & OverRange Registers.....	11
Power Supplies .....	3	Evaluation Board Schematic and Artwork.....	12
Differential Input.....	3	Ordering Information.....	18
Standalone Operation.....	3	Bill of Materials.....	18
Decoupling and Layout Recommendations.....	3	Ordering Guide .....	21
Link Options .....	4	ESD Caution.....	21
Software Instructions for First-Time Use.....	5		

**REVISION HISTORY**

06/09—Rev PrA –Modified for use with EVAL-CED1Z with Rev G of the EVAL-AD7763EDZ evaluation board.

## HARDWARE DESCRIPTION

### POWER SUPPLIES

The EVAL-AD7763EDZ must be powered using an external power supply that applies a 7.5 V between the V+ and GND terminals of Connector J2.

This 7.5 V supply is then regulated on board using ADP3334 devices (U9 and U6) to provide the 2.5 V and 5 V signals required by the AD7763 device. Supplies AV<sub>DD2</sub>, AV<sub>DD3</sub>, and AV<sub>DD4</sub> are the 5 V supplies to the AD7763 device. A voltage of 2.5 V supplies the AD7763 pins AVDD1, VDRIVE, and DVDD.

A separately regulated 2.5 V supply is used to power all digital functionality on the EVAL-AD7763EDZ excluding the AD7763 device. An individually regulated 5 V supply also supplies the crystal oscillator and clock buffer devices on the EVAL-AD7763EDZ.

### DIFFERENTIAL INPUT

The differential input to the AD7763 device is applied through the connector marked J1. This is an XLR audio standard connector. Alternatively there are SMB footprints (J5, J6) that can also be used to apply fully differential analog input signals. The differential inputs are routed through the AD7763 on-board differential amplifier using the external circuit components as detailed in the AD7763 data sheet.

### STANDALONE OPERATION

The EVAL-AD7763EDZ can be used in a standalone manner (that is, without using the EVAL-CED1Z). In this case, however,

the user must provide all the required interface communications and be able to provide a means to acquire the output data from the board.

### DECOUPLING AND LAYOUT RECOMMENDATIONS

The datasheet of the AD7763 devices contains specific information about the decoupling and layout recommendations required to achieve the optimum specifications.

The EVAL-AD7763EDZ adheres to these recommendations completely and is designed as the blueprint for users of the AD7763 devices. The Gerber files for the EVAL-AD7763EDZ board are available for download from the AD7763 product pages at [www.analog.com](http://www.analog.com)

The EVAL-AD7763EDZ is 4-layer boards. One layer is a dedicated ground plane. All supplies to devices on the EVAL-AD7763EDZ are decoupled to this ground plane. In addition to the PCB's top and bottom layers, there is also a layer for routing power signals. See Evaluation Board Schematic and Artwork section to view each layer.

In addition, the exposed paddle of an AD7763 device connects to this ground plane using multiple vias. The exposed paddle does not connect to any of the ground pins on the AD7763 device.

**LINK OPTIONS**

The link options on the evaluation board should be set for the required operating setup before using the board. The functions of these links are described in Table 1.

**Table 1. Link Options**

Link No.	Function	Position Descriptions	Default
LK1	Selects the $V_{DD}$ voltage for Clock Buffers U16 and U2.	Position A selects $V_{DD} = 5V$ . Achieves maximum performance. Position B selects $V_{DD} = 2.5V$	N/A
R9, R10, R35	Leave R9 and R10 open for default use with EVAL-CED1Z. R35 must be in place to link the MCLK signal to the EVAL-CED1Z board to allow for data acquisition using the supplied software.	The Zero Ohm resistor R35 is placed in the cct to connect the MCLK pin of the AD7763 to the FPGA clock output.	R35

# SOFTWARE INSTRUCTIONS FOR FIRST-TIME USE

## INSTALLING THE SOFTWARE

The EVAL-AD7763 evaluation board includes self-installing software on CD ROM, for controlling and evaluating the performance of the AD7763 when it is operated with the EVAL-CED1Z board. The software is compatible with Windows® 2000/XP®/Vista. If the setup file does not run automatically, setup.exe can be run from the CD-ROM.

When the CD is inserted into the PC, an installation program automatically begins. This program installs the evaluation software. The user interface on the PC is a dedicated program written especially for the AD7763 when operating with the EVAL-CEDZ board.

**The software should be installed before the USB cable is connected between the EVAL-CEDZ and the PC.** This ensures that the appropriate USB driver files have been properly installed before the EVAL-CEDZ is connected to the PC.

When the software is ran for the first time with the EVAL-CEDZ board connected to the PC, the PC will automatically find the new device and will identify it. Follow the onscreen instructions that appear automatically. This installs the drivers for the CED on the PC. If an error appears on screen when the software is first opened, then the PC is not recognizing the USB device. This error is corrected by

1. Opening the PC's Device Manager. The Device Manager is accessed by right clicking on the My Computer Icon, and selecting Properties. When the System Properties Window opens, select the Hardware tab.
2. Click on Device Manager in the Hardware Tab of the System Properties window.
3. Examine the devices listed under the Universal Serial Bus Controller heading.
4. If an unknown device is listed, right click on this option and select, Update Driver.
5. The New Hardware Wizard will run twice, and under the ADI Development Tools the following hardware is listed:

ADI Converter Evaluation and Development Board (WF)

6. Reboot the PC.

This section describes how the evaluation board, the EVAL-CEDZ and the software should be set up to begin using the complete system.

1. Insert the CD into the appropriate computer drive.
2. The dialog box shown in Figure 2 appears.

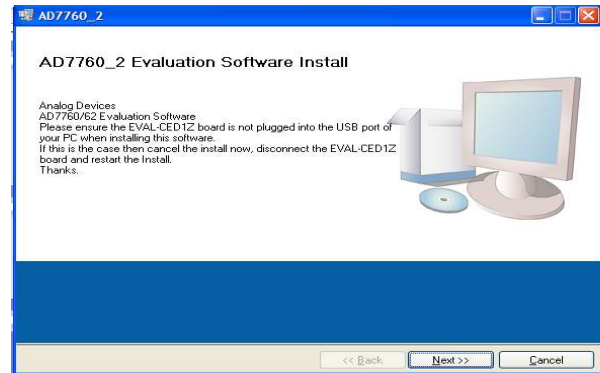

Figure 2. EVAL-AD7763\_2EDZ Setup Dialog Box, Initial Software Install Screen

3. The destination directory can be chosen using the default clicking “Next” as shown in Figure 3). If a different location than the default is preferred, click **Browse** and select the desired location. When ready, click **Next**.

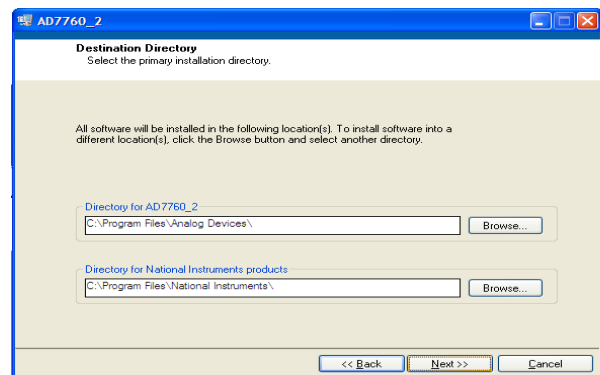

Figure 3. Choose the Destination of the AD776x Software

4. Accept the license agreement by selecting the correct option and clicking “Next” as shown in Figure 4.

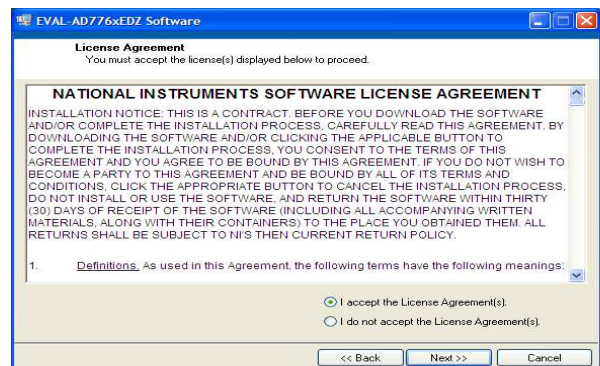

Figure 4. Accept license agreement

- To start the installation, click the “Next” button as shown in Figure 5, this window details the actions of the installation.

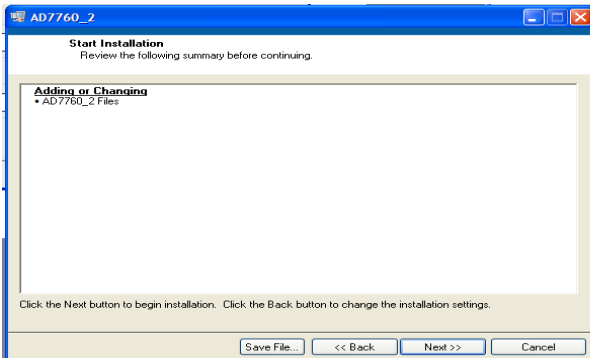

Figure 5. EVAL-AD776xEDZ Install actions

- 
- 
- 
- 
- 
- 
- The software can now be located by following the path that was chosen during installation. If the default location was chosen, the location of the software in the case of the AD7763 is **Start > All Programs > Analog Devices > AD7763 >AD7763**



Figure 6. Default Location of AD7763 Software

- On completion of the installation, the window as shown in Figure 7 is displayed.

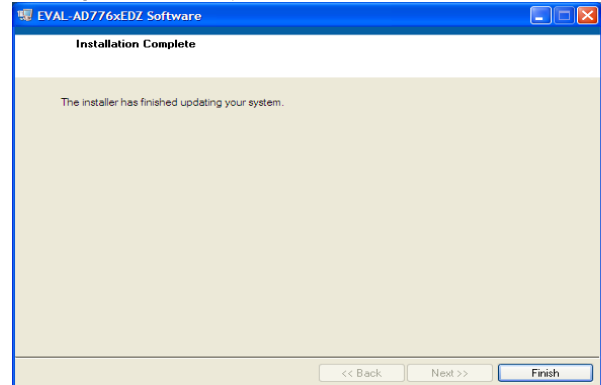

Figure 7. Install Completed

- On completion of the installation, it is advised that the user re-start the PC in order for the software to take full effect.

## USING THE EVALUATION SYSTEM

### HARDWARE CONNECTIONS

1. Apply power to the EVAL-CED1Z via +7V, 15W power supply provided with the EVAL-CED1Z board. At this stage, the green LED labeled 'Power' on the EVAL-CED1Z should be lighting. This indicates that the EVAL-CED1Z is receiving power. The USB cable can then be connected between the PC and the EVAL-CED1Z.
2. Connect the USB cable between the PC and the EVAL-CED1Z. A green LED positioned beside the USB connector on the EVAL-CEDZ board will light indicating that the USB connection has been established.
3. Power up the EVAL-AD7763EDZ evaluation board through Connector J2. Connect a wire from the V+ labeled connector to 7.5 V of an external power supply. Also ensure that there is a GND connection between the GND of J2 and the power supply GND connection.
4. Connect the female connector (J13, marked "CED1Z SPORT INTERFACE), which is on the underside of the EVAL-

AD7763EDZ evaluation board to the header (J12) marked "SPORT Interface" of the EVAL-CED1Z board.

5. Start the EVAL-AD7763EDZ software.

The differential input to the AD7763 device can be connected to the black connector XLR connector (J1) marked "Differential Input." This differential input is routed to the inputs of the AD7763's on-board differential amplifier. As the software will power up the AD7763 device it is advisable that users do not apply an analog input until the device is fully powered up.

With the hardware set up, you can now use the software to control the EVAL-CED1Z and the AD7763 evaluation board. To launch the software, from the **Analog Devices** menu click on the **AD7763** submenu, then click on the **AD7763 icon**.

Note: In the case where an Error message appears, click OK and restart the application after checking the connection between the adapter board and the USB port on the PC. Also, check that the USB device is identified by the Device Manager as detailed in the first time use of EVAL-CED1Z paragraph of Installing the Software section.

## SOFTWARE INSTRUCTIONS FOR NORMAL USE

Once the initial software installation has been completed, follow these instructions for the general setup of the evaluation software each subsequent time the system is used.

Note that the hardware must be powered up as per the Hardware connections section before attempting the following steps.

1. The download default location for the EVAL-AD7763/AD7762EDZ evaluation software can be found by clicking **Start > All Programs > Analog Devices > AD7763 > AD7763**. If a location other than the default was used, follow the path that was entered during setup.
2. The evaluation software GUI appears –see Figure 10 there are five main control sections as described.
3. AD7763 is selected from the drop down box on the front panel.
4. To Power up the AD7763 device under evaluation, first click the Power Mode drop down menu, and select either 'Low Power' or 'Normal Power'. This will automatically prompt the EVAL-CED1Z to write to the AD7763 registers and power up the AD7763 device.

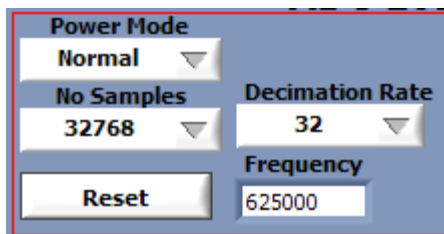

Figure 8. Power, Number of Samples, Decimation Rate and Modulator Mode Control buttons.

5. Note that the external voltage supply connected to the EVAL-AD7763EDZ board will show approximately ~240mA in 'Normal Power' mode, and approx ~170mA in 'Low Power mode. Seeing this current draw levels change, when switching between the power modes also verifies that the communications between the EVAL-AD7763EDZ and EVAL-CED1Z board are operational.
6. The AD7763 device will power up in a default decimation setting of 32. Change the Decimation Rate setting by clicking on the Decimation rate drop down control as

shown in Figure 8. This allows the user to vary the over sampling rate and implement the four on-chip decimation options offering from a 78kHz to 625kHz output data rate from the AD7763.

7. The user can specify the power mode, decimation rate, and number of samples to be acquired (typically 65536 samples) by using the drop-down menus on the software front panel. The software allows the number of samples specified by the user samples to be viewed as a waveform, histogram, or FFT.

The choosing the different decimation rates from the front panel controls writes to the AD7763 control register 2 to change the amount of decimation used in the second internal FIR filter of the AD7763. This filter can be set bypassed to enable decimate x8 mode or otherwise set to decimate x8 to x32 in order to enable an overall decimation rate of 32 to 256 for the AD7763 device.

8. To show samples output by the EVAL-AD7763/EBZ evaluation board Click **Sample** or **Continuous**. Clicking **Sample** gives one set of samples, the length of which is determined by the **No. Samples** selection on the software front panel. Clicking **Continuous** shows continuously updated samples of the analog input to the device.

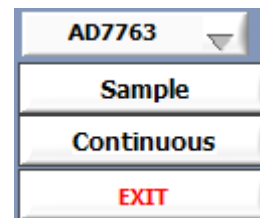

Figure 9.

9. It is important to ensure that the frequency of the  $\overline{\text{DRDY}}$  pulse on an oscilloscope (test point marked  $\backslash\text{DRDY}$ ) is checked so that it matches the frequency shown in the **Frequency** text box on the software front panel.
10. If at any stage these do not match, reset the AD7763 evaluation board by pressing the  $\overline{\text{RESET}}$  push button on the evaluation board –set the power mode and decimation rate on the software front panel to the correct default value and then sample again.



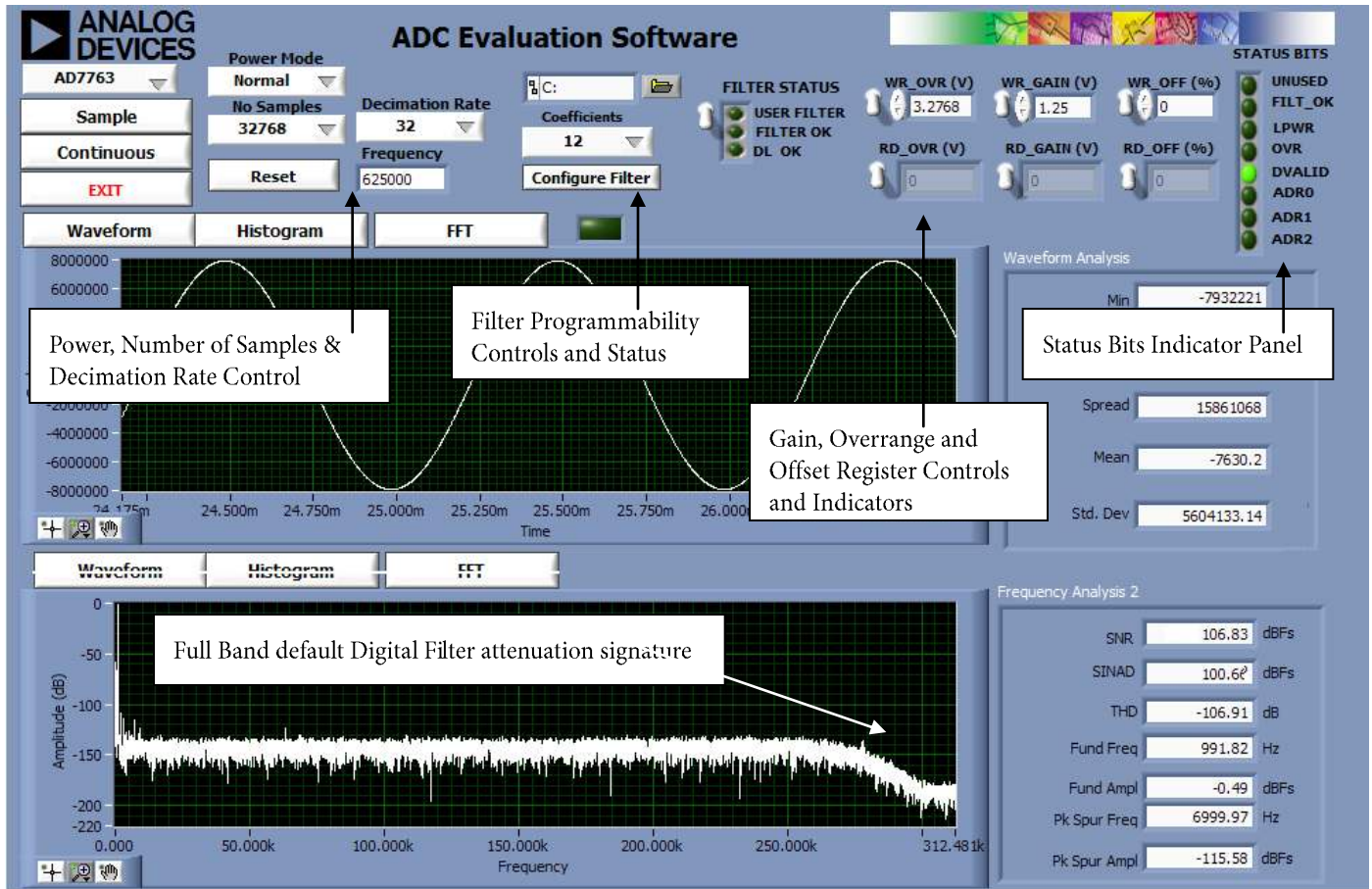

Figure 10. Front Panel GUI showing control and indicator information and the performance with a -0.5dB 1 kHz input tone in decimate by 32 mode when running with the default 40MHz MCLK

**DOWNLOADING A USER-DEFINED FILTER**

The final stage of the AD7763FIR filter can be programmed to suit the user’s specific requirements. The filter designed must correspond with the requirements listed in the datasheet – it must be a symmetrical filter with an even number of coefficients. The number of coefficients can be from 12 to 96.

- Due to the symmetry of the filter, the coefficients will repeat. Thus, only half of the coefficients are required to be sent to the AD7763device.
- The AD7763 software reads the coefficients from a text file and writes each coefficient to the AD7763. The filter file should contain the correct checksum, which is also written to the ADC, and the file must be in the correct format.

11. An example of this format is shown in Figure 11. This example corresponds to the example digital filter in the Downloading A User Defined Filter section in the AD7763datasheet.
12. Each of the 32 bit words (in this case there are 12 words for the coefficients + the checksum) are in a Hexadecimal format – there must also be no spaces between the characters and no text, spaces or notation before or after any of the hex words to be written. The software implements a text read from each line of the file and then translates this value to the correct binary 32 –bit word to be written to the AD7763as per the description in the datasheet.

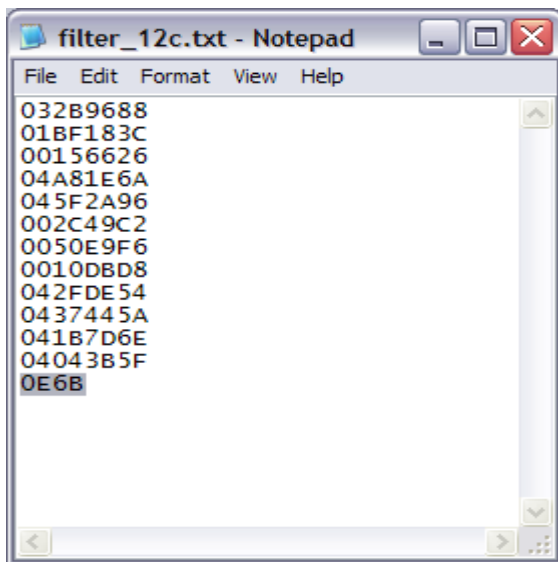

Figure 11.Example of format required for filter coefficients to be downloaded correctly.

13. To download a filter,
  - a) Select the number of coefficients that will be downloaded – this is half the filter length – so if you have a 24 tap filter you select 12 in the drop down selection shown in Figure 12.

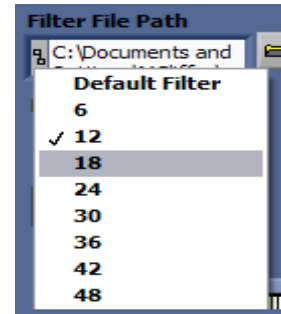

Figure 12.Number of coefficients to be sent to the AD7763device.

- b) Now click on the folder icon and browse to the location of the filter text file. The install will have placed a copy of the datasheet example at C:\Program Files\Analog Devices\AD7763 this file is called “filter\_12c.txt”

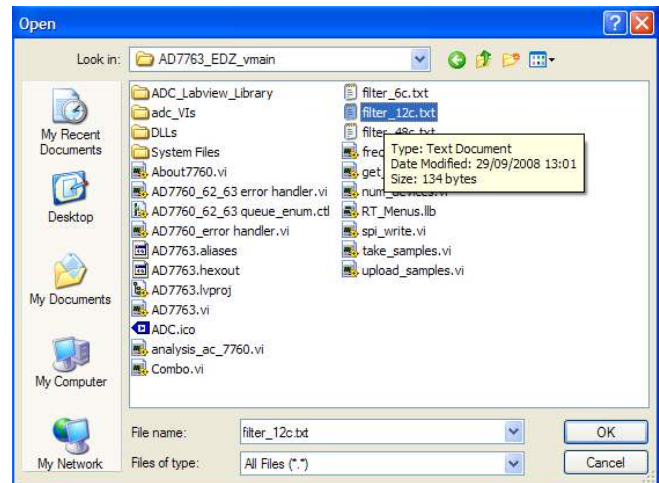

Figure 13.Browse to select the specific text file.

- c) Finally click the “Configure Filter” button to download the user-defined filter.
- d) Once this is done then, click the “Sample” button to acquire a batch of samples from the AD7763device.
- e) The filter example used in the AD7763datasheet will show a slower transition band. The FFT of this filter implementation is shown in Figure 14. As highlighted, the status bits output by the ADC will show if the filter file has been downloaded correctly. The indicators for the DL\_OK, FILT\_OK and UFLT are all asserted to show a successful filter download.

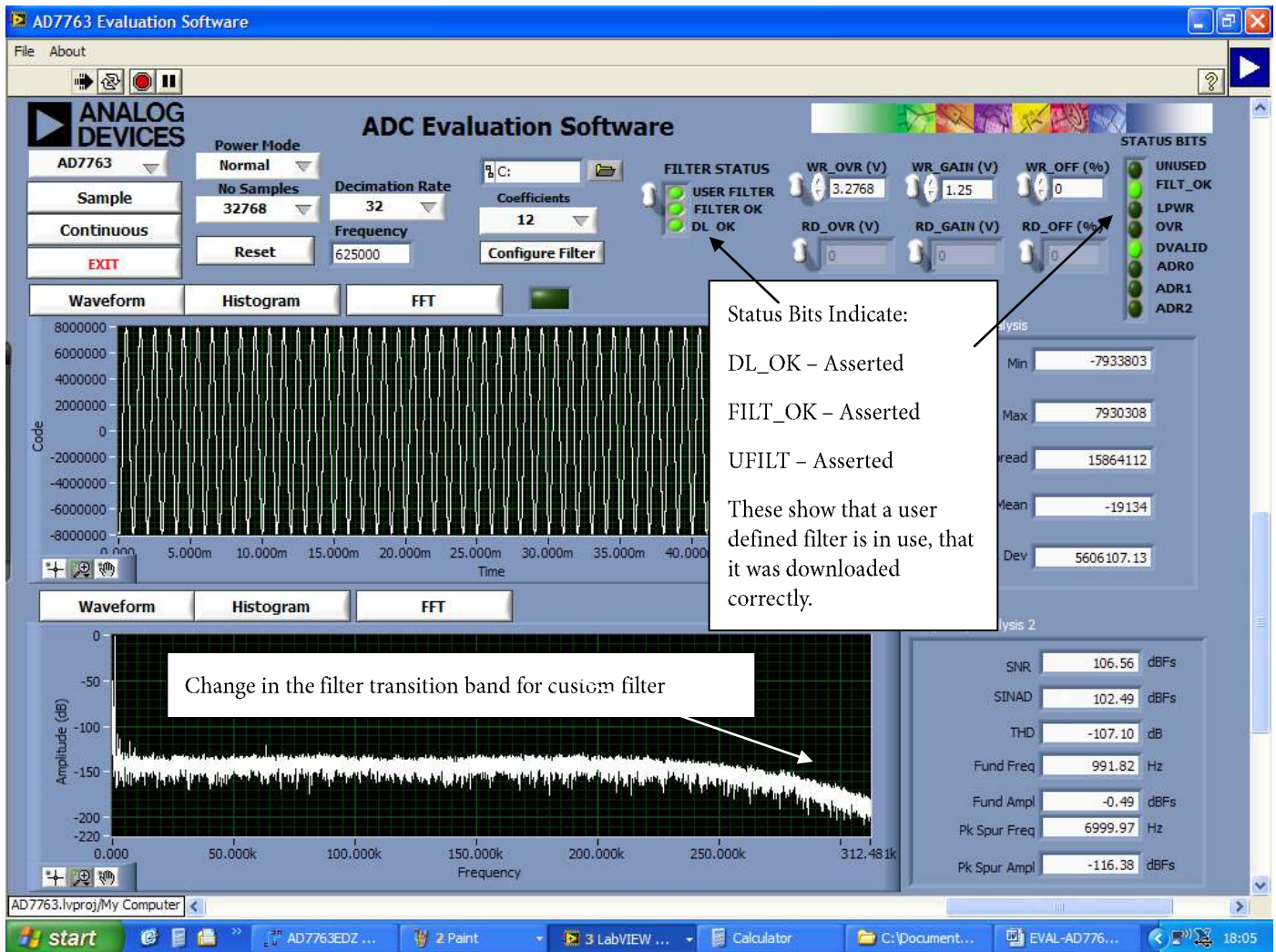

Figure 14. User-defined filter example – implemented on evaluation board. See indicators illuminated, and custom filter transition band.

**WRITING TO GAIN, OFFSET & OVERRANGE REGISTERS**

14. The EVAL-AD7763EDZ board allows the user to write to the on-board registers for control of gain correction, offset correction, and the setting of the overrange flag.
15. As an example of this, the default value of the gain correction register, 1.25 can be changed to a value of 1.00. Do this by setting the value in the WR\_GAIN text box to 1.00. Click on the white WR\_GAIN switch on the front panel in order to write to the gain register.
16. To check that the value has been written correctly click on the white RD\_GAIN switch on the front panel and the value of the AD7763gain register will be shown in the RD\_GAIN indicator box.

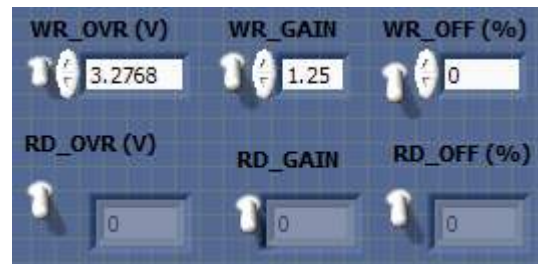

Figure 15. Overrange, Gain, Offset register Write and Read functions.

EVALUATION BOARD SCHEMATIC AND ARTWORK

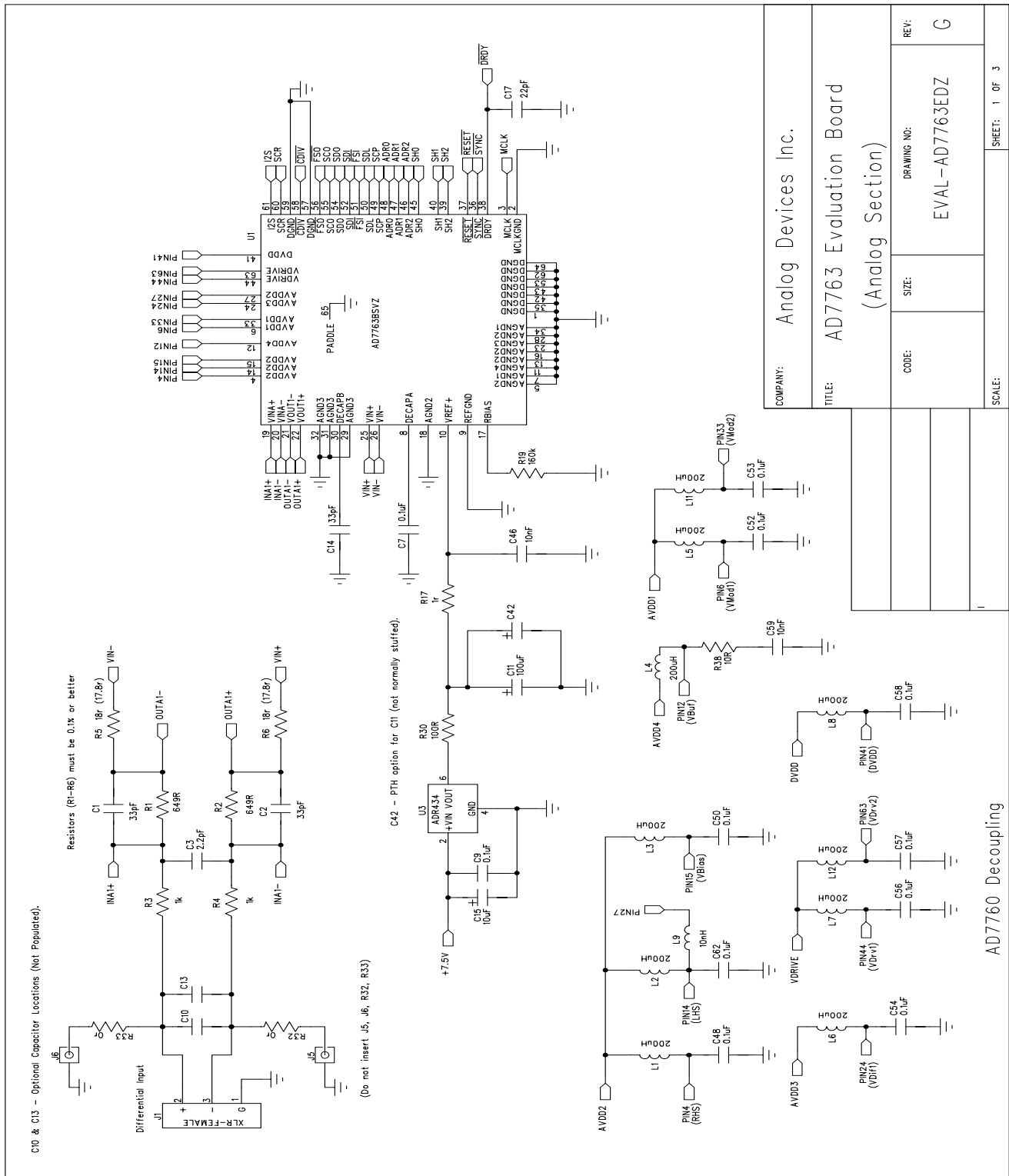
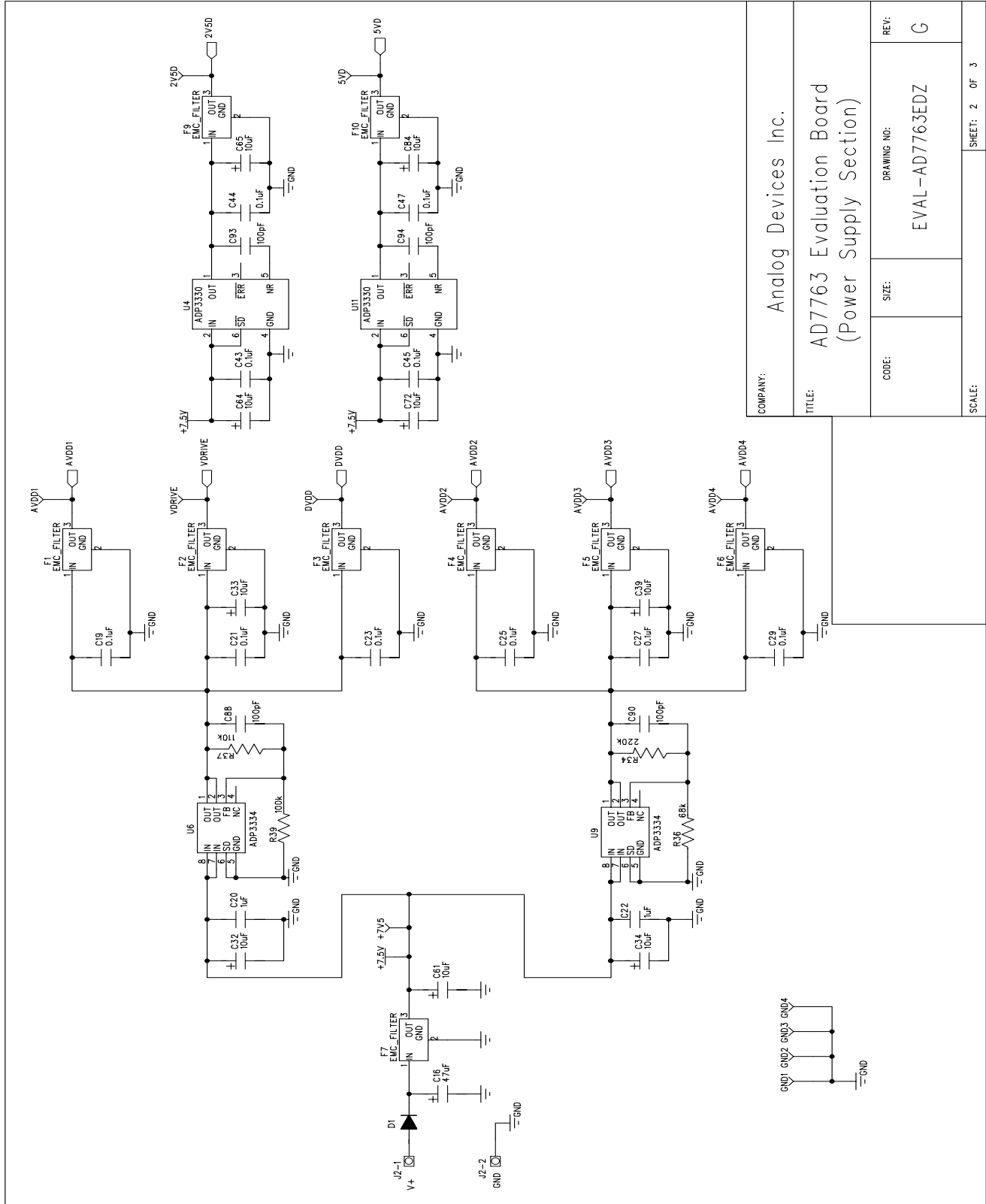

Figure 16. EVAL-AD7763EDZ Schematic (Analog Section Rev.G) Page 1 of 3



COMPANY:		Andlog Devices Inc.	
TITLE:		AD7763 Evaluation Board (Power Supply Section)	
CODE:	SIZE:	DRAWING NO:	REV:
		EVAL-AD7763EDZ	G
SCALE:			SHEET: 2 OF 3

Figure 17. EVAL-AD7763EDZ Schematic (Power Supply Section Rev G) Page 2 of 3

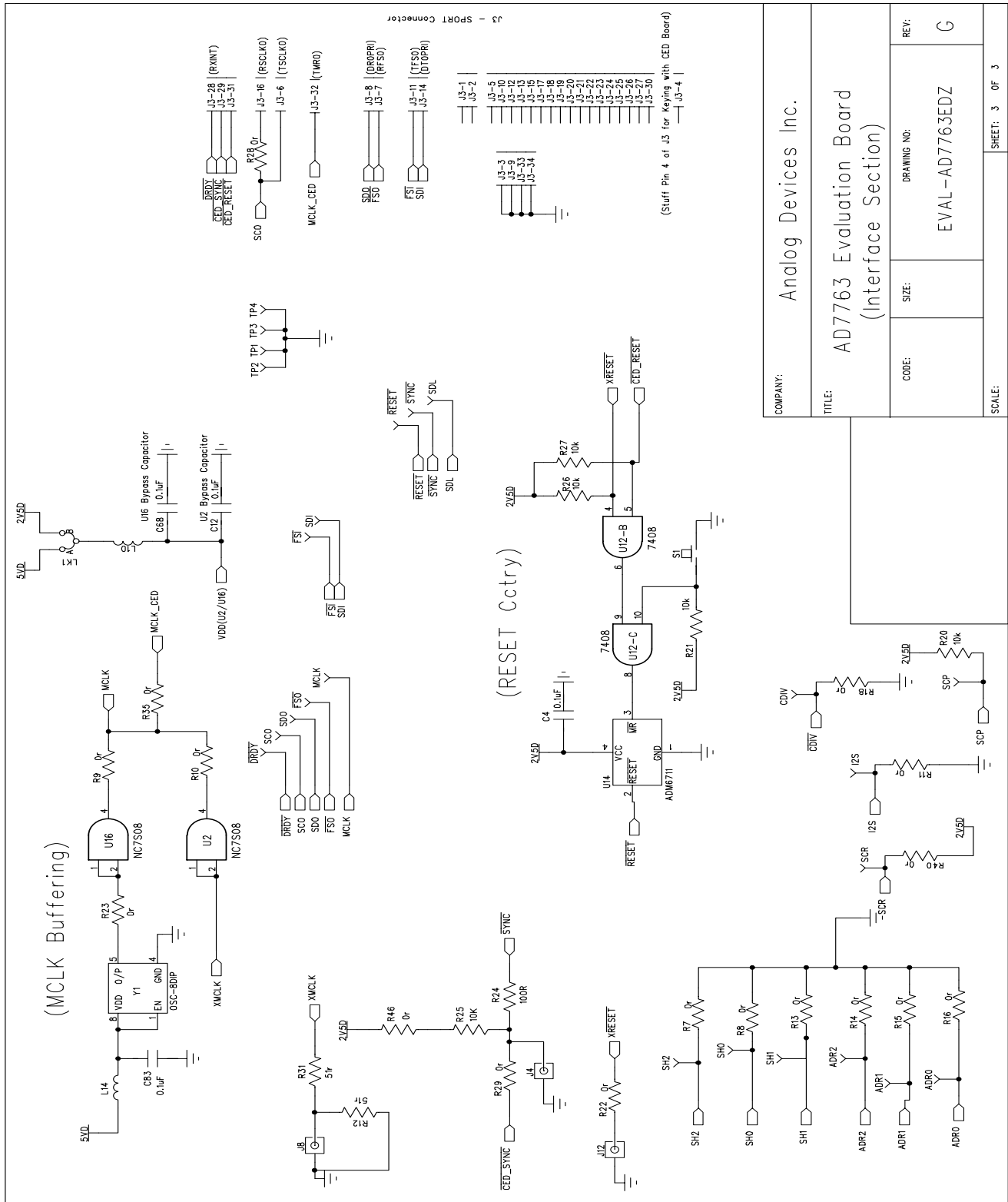
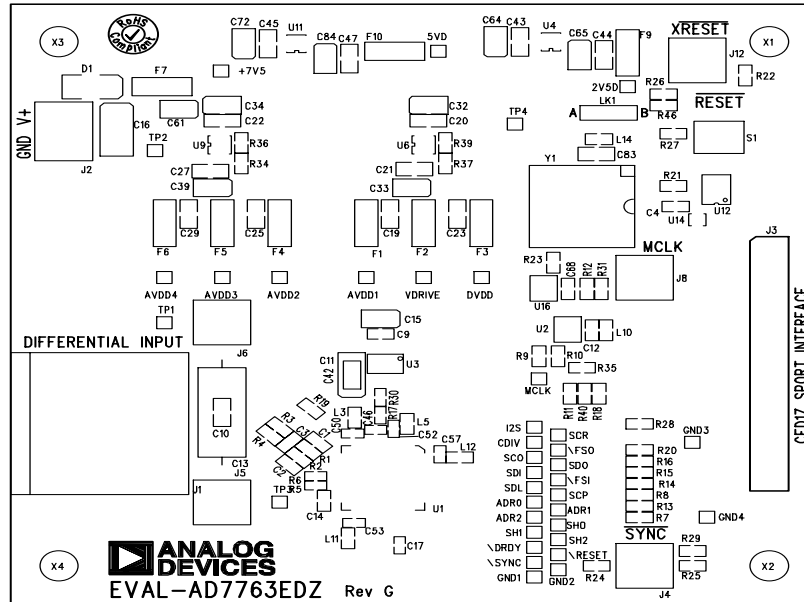

Figure 18. EVAL-AD7763EDZ Schematic (Interface Section Rev F) Page 3 of 3

COMPANY:		Analog Devices Inc.	
TITLE:		AD7763 Evaluation Board (Interface Section)	
CODE:	SIZE:	DRAWING NO:	REV:
		EVAL-AD7763EDZ	G
SCALE:			SHEET: 3 OF 3



EVAL-AD7763EDZ (Rev. G) – Component Side View  
Silkscreen Top

Figure 19. EVAL-AD7763EDZ Component Side Top Silkscreen Artwork

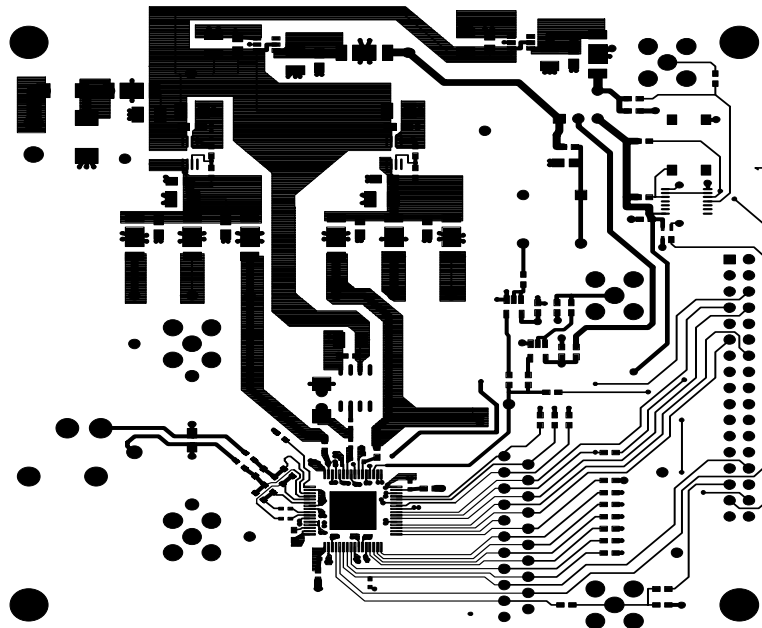

EVAL-AD7763EDZ (Rev. G) – Component Side View  
Component Side – Layer 1

Figure 20. EVAL-AD7763EDZ Component Side Layer 1 Artwork

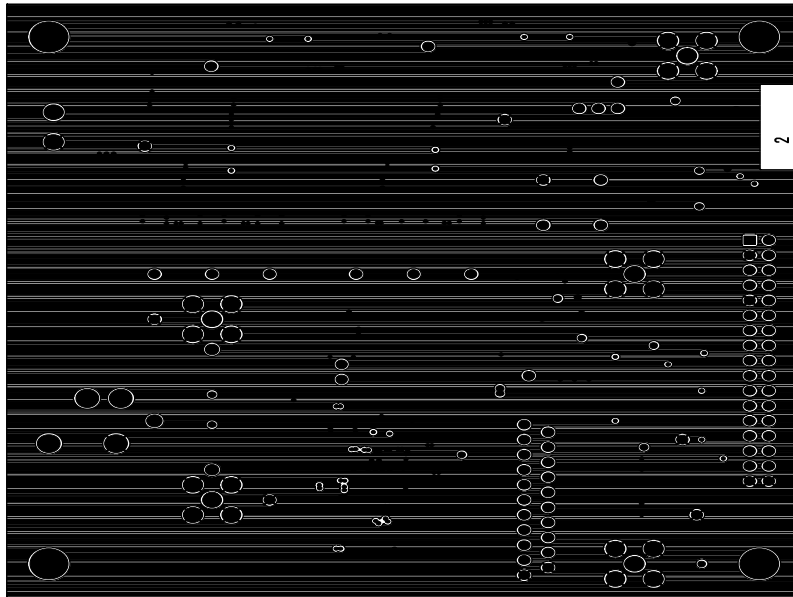

EVAL-AD7763EDZ (Rev. G) – Component Side View

Ground Plane – Layer 2

Figure 21. EVAL-AD7763EDZ Ground Plane Layer 2 Artwork

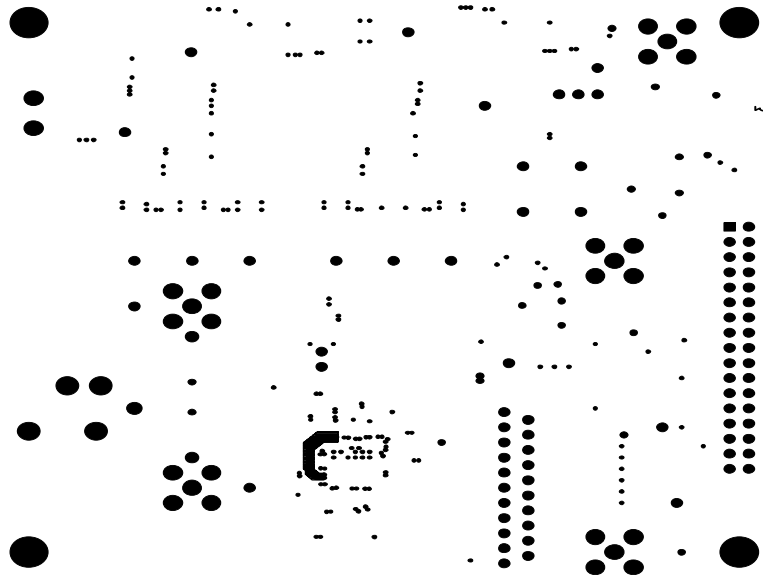

EVAL-AD7763EDZ (Rev. G) – Component Side View

Power – Layer 3

Figure 22. EVAL-AD7763EDZ Power Plane Layer 3 Artwork



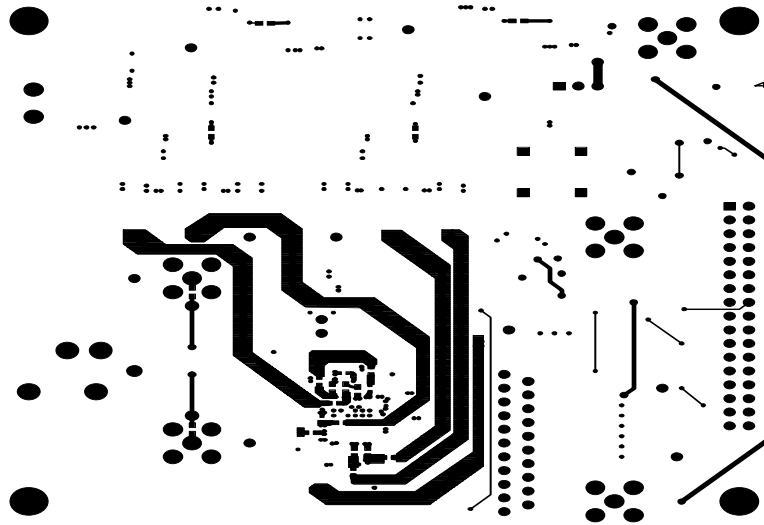

EVAL-AD7763EDZ (Rev. G) – Component Side View

Solder Side – Layer 4

Figure 23. EVAL-AD7763EDZ Solder Side Layer 4 Artwork

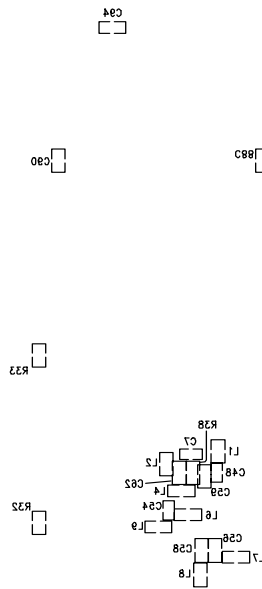

EVAL-AD7763EDZ (Rev. G) – Component Side View

silkscreen Bottom

Figure 24. EVAL-AD7763EDZ Component Side Bottom Silkscreen Artwork

## ORDERING INFORMATION

## BILL OF MATERIALS

Table 2.( Stock codes showing "FEC" refer to Farnell components directory.)

Name	Value	PCB Decal	PART DESC	STOCK CODE
C1	33pF	50V NPO Multilayer Ceramic AVX	06035A330JAT2A	FEC 498555
C2	33pF	50V NPO Multilayer Ceramic	06035A330JAT2A	FEC 498555
C3	2.2pF	50V NPO Multilayer Ceramic	2238 867 15228	FEC 721888
C4	0.1uF	16V X7R Multilayer Ceramic	B0603R104KCT	FEC 9406140
C7	0.1uF	16V X7R Multilayer Ceramic	2238 787 19849	FEC 3019482
C9	0.1uF	16V X7R Multilayer Ceramic	B0603R104KCT	FEC 9406140
C10	n/a	Optional Cap Footprint (0805)	Not inserted	n/a
C11	100uF	10v Tantalum Capacitor	TAJC107K010R	FEC 197180
C12	0.1uF	16V X7R Multilayer Ceramic	B0603R104KCT	FEC 9406140
C13	n/a	Optional Cap Footprint	Not inserted	n/a
C14	33pF	50V NPO Multilayer Ceramic	06035A330JAT2A	FEC 498555
C15	10uF	20V Tantalum Capacitor	TAJB106K020R	FEC 197427
C16	47uF	20V Tantalum Capacitor	TAJD476K020R	FEC 197464
C17	22pF	50V C0G Multilayer Ceramic	GRM1555C1H220JZ01D	FEC 8819629
C19	0.1uF	50V X7R Multilayer Ceramic	U0805R104KCT	FEC 9406387
C20	1uF	16V X7R Multilayer Ceramic Capacitor	GRM21BR71C105KA01L	FEC 9527710
C21	0.1uF	50V X7R Multilayer Ceramic Capacitor	U0805R104KCT	FEC 9406387
C22	1uF	16V X7R Multilayer Ceramic Capacitor	GRM21BR71C105KA01L	FEC 9527710
C23	0.1uF	50V X7R Multilayer Ceramic Capacitor	U0805R104KCT	FEC 9406387
C25	0.1uF	50V X7R Multilayer Ceramic Capacitor	U0805R104KCT	FEC 9406387
C27	0.1uF	50V X7R Multilayer Ceramic Capacitor	U0805R104KCT	FEC 9406387
C29	0.1uF	50V X7R Multilayer Ceramic Capacitor	U0805R104KCT	FEC 9406387
C32	10uF	20V Tantalum Capacitor	TAJB106K020R	FEC 197427
C33	10uF	20V Tantalum Capacitor	TAJB106K020R	FEC 197427
C34	10uF	20V Tantalum Capacitor	TAJB106K020R	FEC 197427
C39	10uF	20V Tantalum Capacitor	TAJB106K020R	FEC 197427
C42	n/a	PTH Capacitor Location	Not inserted	n/a
C43	0.1uF	50V X7R Multilayer Ceramic Capacitor	U0805R104KCT	FEC 9406387
C44	0.1uF	50V X7R Multilayer Ceramic Capacitor	U0805R104KCT	FEC 9406387
C45	0.1uF	50V X7R Multilayer Ceramic Capacitor	U0805R104KCT	FEC 9406387
C46	10nF	16V X7R Multilayer Ceramic Capacitor	CM05X7R103K16AT	FEC 578149
C47	0.1uF	50V X7R Multilayer Ceramic Capacitor	U0805R104KCT	FEC 9406387
C48	0.1uF	16V Y5V Multilayer Ceramic Capacitor	2238 787 19849	FEC 3019482
C50	0.1uF	16V Y5V Multilayer Ceramic Capacitor	2238 787 19849	FEC 3019482
C52	0.1uF	16V Y5V Multilayer Ceramic Capacitor	2238 787 19849	FEC 3019482
C53	0.1uF	16V Y5V Multilayer Ceramic Capacitor	2238 787 19849	FEC 3019482
C54	0.1uF	16V Y5V Multilayer Ceramic Capacitor	2238 787 19849	FEC 3019482
C56	0.1uF	16V X7R Multilayer Ceramic Capacitor	B0603R104KCT	FEC 9406140
C57	0.1uF	16V Y5V Multilayer Ceramic Capacitor	2238 787 19849	FEC 3019482
C58	0.1uF	16V X7R Multilayer Ceramic Capacitor	B0603R104KCT	FEC 9406140
C59	10nF	25V X7R Multilayer Ceramic Capacitor	06033C103KAT2A	FEC 499146
C61	10uF	20V Tantalum Capacitor	TAJB106K020R	FEC 197427
C62	0.1uF	16V X7R Multilayer Ceramic Capacitor	B0603R104KCT	FEC 9406140
C64	10uF	20V Tantalum Capacitor	TAJB106K020R	FEC 197427
C65	10uF	20V Tantalum Capacitor	TAJB106K020R	FEC 197427

Name	Value	PCB Decal	PART DESC	STOCK CODE
C68	0.1uF	16V X7R Multilayer Ceramic Capacitor	B0603R104KCT	FEC 9406140
C72	10uF	20V Tantalum Capacitor	TAJB106K020R	FEC 197427
C83	0.1uF	50V X7R Multilayer Ceramic Capacitor	U0805R104KCT	FEC 9406387
C84	10uF	20V Tantalum Capacitor	TAJB106K020R	FEC 197427
C88	100pF	50V NPO Multilayer Ceramic Capacitor	U0603C101JCT	FEC 9406115
C90	100pF	50V NPO Multilayer Ceramic Capacitor	U0603C101JCT	FEC 9406115
C93	100pF	50V NPO Multilayer Ceramic Capacitor	U0603C101JCT	FEC 9406115
C94	100pF	50V NPO Multilayer Ceramic Capacitor	U0603C101JCT	FEC 9406115
D1		2A Rectifier Diode	S2M	FEC 9843876
F1	1nF	1nF 3-Terminal EMC_FILTER	NFE61PT102E1H9L	FEC 9528202
F2	1nF	1nF 3-Terminal EMC_FILTER	NFE61PT102E1H9L	FEC 9528202
F3	1nF	1nF 3-Terminal EMC_FILTER	NFE61PT102E1H9L	FEC 9528202
F4	1nF	1nF 3-Terminal EMC_FILTER	NFE61PT102E1H9L	FEC 9528202
F5	1nF	1nF 3-Terminal EMC_FILTER	NFE61PT102E1H9L	FEC 9528202
F6	1nF	1nF 3-Terminal EMC_FILTER	NFE61PT102E1H9L	FEC 9528202
F7	1nF	1nF 3-Terminal EMC_FILTER	NFE61PT102E1H9L	FEC 9528202
F9	1nF	1nF 3-Terminal EMC_FILTER	NFE61PT102E1H9L	FEC 9528202
F10	1nF	1nF 3-Terminal EMC_FILTER	NFE61PT102E1H9L	FEC 9528202
J1		XLR Female Audio Connector	NC3FAH1-1	FEC 724518
J2		2 Pin Terminal Block (5mm Pitch)	CTB5000/2	FEC 151789
J3		34-Pin 0.1" Pitch DIL Vertical PC Tail Socket Assembly, tin, 17+17-way	M20-7831746	Mouser 855-M20-7831746
J12		50 Ohm SMB Jack	Radiall R114426000	FEC 4194512
L1		Ferrite Bead	74279266LF	74279266LF
L2		Ferrite Bead	74279266LF	74279266LF
L3		Ferrite Bead	74279266LF	74279266LF
L4		Ferrite Bead	74279266LF	74279266LF
L5		Ferrite Bead	74279266LF	74279266LF
L6		Ferrite Bead	74279266LF	74279266LF
L7		Ferrite Bead	74279266LF	74279266LF
L8		Ferrite Bead	74279266LF	74279266LF
L9	10nH	Inductor	Epcos B82496C3100J	FEC 3877024
L10		Ferrite Bead	74279266LF	74279266LF
L11		Ferrite Bead	74279266LF	74279266LF
L12		Ferrite Bead	74279266LF	74279266LF
L14		Ferrite Bead	74279266LF	74279266LF
LK1		3 Pin SIL Header (with shorting block)	M20-9990345	FEC 1022248 & FEC 148029
MCLK		Red Testpoint	Holes to be left free of solder	FEC 8731144 (Pack)
R1	649R (0.1%)	Precision SMD Resistor	RN73C1J649RBTG	FEC 1140503
R2	649R (0.1%)	Precision SMD Resistor	RN73C1J649RBTG	FEC 1140503
R3	1k (0.1%)	Precision SMD Resistor	RN73C1J1K0BTG	FEC 1140509
R4	1k (0.1%)	Precision SMD Resistor	RN73C1J1K0BTG	FEC 1140509
R5	17.8r (0.1%)	Precision SMD Resistor	RN73C1J17R8BTG	FEC 1140429
R6	17.8r (0.1%)	Precision SMD Resistor	RN73C1J17R8BTG	FEC 1140429
R7	0r	SMD Resistor	MC 0.063W 0603 0R	FEC 9331662
R8	0r	SMD Resistor	MC 0.063W 0603 0R	FEC 9331662
R9	0r	SMD Resistor	MC 0.063W 0603 0R	FEC 9331662
R10	0r	SMD Resistor	n/a	n/a

Name	Value	PCB Decal	PART DESC	STOCK CODE
R11	0r	SMD Resistor	Multicomp	FEC 9331662
R12	51r	SMD Resistor	Multicomp	FEC 9331336
R13	0r	SMD Resistor	Multicomp	FEC 9331662
R14	0r	SMD Resistor	Multicomp	FEC 9331662
R15	0r	SMD Resistor	Multicomp	FEC 9331662
R16	0r	SMD Resistor	Multicomp	FEC 9331662
R17	1r	SMD Resistor (p/n is 0603 - will fit in 0402 footprint used on PCB)	2322704610081R	FEC 9238123
R18	0r	SMD Resistor 0.063W	Multicomp	FEC 9331662
R19	160k	SMD Resistor 0.063W	Multicomp	FEC 9330682
R20	10k	SMD Resistor 0.063W	Multicomp	FEC 9330399
R21	10k	SMD Resistor 0.063W	Multicomp	FEC 9330399
R22	0r	SMD Resistor 0.063W	Multicomp	FEC 9331662
R23	0r	SMD Resistor 0.063W	Multicomp	FEC 9331662
R24	100R	SMD Resistor 0.063W	Multicomp	FEC 9330364
R25	10K	SMD Resistor 0.063W	Multicomp	FEC 9330399
R26	10k	SMD Resistor 0.063W	Multicomp	FEC 9330399
R27	10k	SMD Resistor 0.063W	Multicomp	FEC 9330399
R28	0r	SMD Resistor 0.063W	Multicomp	FEC 9331662
R29	0r	SMD Resistor	n/a	n/a
R30	100R	SMD Resistor 0.063W	MC 0.063W 0603 100R	FEC 9239111
R31	51r	SMD Resistor 0.063W	MC 0.063W 0603 51R	FEC 9331336
R32	0r	SMD Resistor	n/a	n/a
R33	0r	SMD Resistor	n/a	n/a
R34	220k	SMD Resistor 0.063W	MC 0.063W 0603 220K	FEC 9330836
R35	0r	SMD Resistor 0.063W	MC 0.063W 0603 0R	FEC 9331662
R36	68k	SMD Resistor 0.063W	MC 0.063W 0603 68K	FEC 9331468
R37	110k	SMD Resistor 0.063W	MC 0.063W 0603 110K	FEC 9330461
R38	10R	SMD Resistor 0.063W	MC 0.063W 0603 10R	FEC 9330429
R39	100k	SMD Resistor 0.063W	MC 0.063W 0603 100K	FEC 9330402
R40	0r	SMD Resistor 0.063W	MC 0.063W 0603 0R	FEC 9331662
R46	0r	SMD Resistor	n/a	n/a
S1		SMD Push Button Switch (sealed 6mm x 6mm)	B35-1000	FEC 177-807
U1	AD7763BSVZ	Analog to digital Converter	AD776x Analog-to-digital Converter	AD7763BSVZ
U2	NC7S08	Single 2-Input AND Gate	NC7SZ08M5	FEC 1013807
U3	ADR434	Voltage Reference	Code on device to read L1B	ADR434ARZ
U4	ADP3330	Low Dropout Regulator	Code on device to read L1B	ADP3330ARTZ-2.5
U6	ADP3334	Low Dropout Regulator	ADP3334ARMZ	ADP3334ARMZ
U9	ADP3334	Low Dropout Regulator	ADP3334ARMZ	ADP3334ARMZ
U11	ADP3330	Low Dropout Regulator	Code on device to read L8B	ADP3330ARTZ-5
U12	7408	QUAD 2-INPUT POS-AND GATE	SN74LVC08APWR	FEC 1102978
U14	ADM6711	Reset Generator	ADM6711ZAKSZ	ADM6711ZAKSZ
U16	NC7S08	Single 2-Input AND Gate	NC7SZ08M5	FEC 1013807
Y1	40MHz	<a href="http://www.ctscorp.com/components/xo.asp">http://www.ctscorp.com/components/xo.asp</a>	MX045HS40M0000	Digikey CTX175-ND

**ORDERING GUIDE**

Model	Description
EVAL-AD7763EDZ	Evaluation Kit
EVAL-CED1Z	Converter Evaluation and Development (CED) Board

**ESD CAUTION**



**ESD (electrostatic discharge) sensitive device.** Charged devices and circuit boards can discharge without detection. Although this product features patented or proprietary protection circuitry, damage may occur on devices subjected to high energy ESD. Therefore, proper ESD precautions should be taken to avoid performance degradation or loss of functionality.

**NOTES**