

MS Series Input/Output Module Mounting Boards

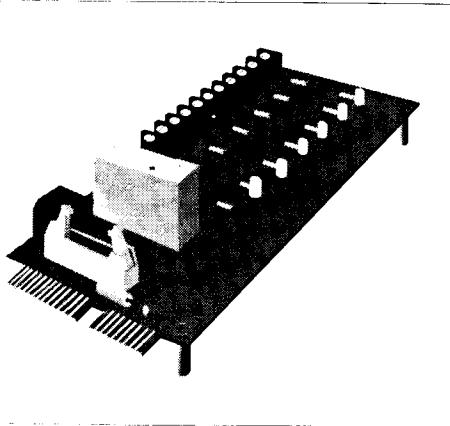

Crydom Series MS Mounting Boards are designed to accommodate up to 24 input/output Crydom Series IAC, Series 6 or DMP modules or equivalents in any mix. Modules can be easily inserted and removed without disturbing field wiring. Each I/O Module is firmly secured by a captive screw which mates with a threaded insert in the mounting board. Field wiring connections are made with wire clamping terminals that allow straight-in insertions of two wires using UL, CSA recognised barrier strips.

MS 'H' Series Boards

Field lines and data control lines are protected by a solder mask coating and separated by ground traces and a ground plane to minimise cross talk. Each data line has a 3.3K ohm pull-up resistor. Each field pair includes a plug-in replaceable 5A fuse to protect the wiring and/or load.

Connector Options

Except for the Model MS-4, Crydom mounting boards include both ribbon card edges and cable header pinout patterns to allow maximum flexibility for connecting to microprocessor boards. (A Logic Interface Connector table indicates the type of connectors each mounting board will accept.)

GENERAL SPECIFICATIONS	PART NUMBERS				
	MS4	MS4H	MS8H	MS16H	MS24H
Module Positions	4	4	8	16	24
Input/output Channels	4	4	8	16	24

Due to space restrictions we are unable to provide full technical specifications for these mounting boards in this publication. Comprehensive data detailing circuit configurations and dimensional drawings are available upon request.

SOLID STATE RELAY SPECIFIER'S CHECK LIST

As with most semiconductor based products there are many parameters which should be considered when specifying SSRs. Due consideration must be given to the following key points to ensure satisfactory operation.

- 1. INPUT** The drive source must be sufficient to meet the **MUST TURN-ON** voltage and **INPUT CURRENT** requirements in order to guarantee switch-on.
- 2. SURGE RATING** For switching inductive loads the expected in-rush currents must not exceed the **SURGE CURRENT** ratings. Back EMF must also be evaluated so that the **TRANSIENT OVER VOLTAGE** rating is not exceeded.
- 3. SUPPRESSION** Many of the **CRYDOM** SSRs are provided with internal snubber networks to help suppress transient voltage and dv/dt . In situations where these parameters exceed published data for a given SSR, additional suppression such as **MOV**s must be considered.
- 4. TEMPERATURE** All **MAX. LOAD CURRENT** ratings are true for ambient temperatures to 30°C . The current ratings must be derated for ambients above this level. With chassis mount devices the max. current can be maintained by the selection of a suitable heatsink.
- 5. LEAKAGE CURRENT** In their **OFF STATE** all SSRs exhibit a leakage current. This current varies from series to series. The typical range is 0.1mA for **CX** Series to 10mA for Series 1. The leakage current should be taken into account for low power motors, solenoids, etc. to ensure error free turn-off.

Mounting Boards for Microprocessor Interface Input/Output Modules

LOGIC INTERFACE CONNECTORS

CRYDOM mounting boards offer both card edge and header patterns to allow for standard flat cable connection to microprocessor boards. The Logic Interface Connector table indicates the type of connectors each MS-H mounting board will accept. (Contacts spaced on 0.10" centres).

Recommended connectors and suppliers	26-pin card edge connector (T&B/Ansley P/N 609-2615M or equivalent). Suitable for MS-8H only.
	40-pin header (T&B/Ansley P/N 609-4037E or equiv.) with matching female socket connector (T&B/Ansley P/N 609-4030 or equivalent).
	50-pin card edge connector (T&B/Ansley P/N 609-5015M or equivalent).

Data/Control Lines

The module data/control lines are assigned odd numbered pins on each connector. They are separated by ground traces and a ground plane to minimize cross talk, which terminates at the even numbered pins. Each data line has a 3.3KΩ pull-up resistor. LED indicators are included at each module location for on/off status.

Power

Power (+Vcc) is introduced by means of a dual barrier strip (except the MS-4 and MS-4H). Other options include entry via the cable on pin 1 or pin 49, enabled by means of customer-installed jumpers. Decoupling capacitors are provided for noise protection and also to minimize cross talk.

MS-4 Schematic

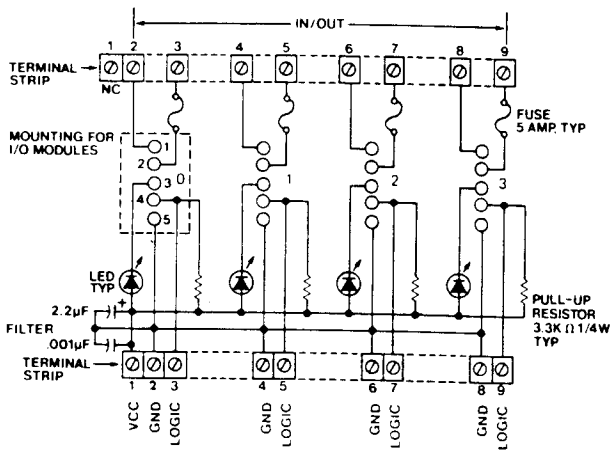

MS-4 Mounting Board

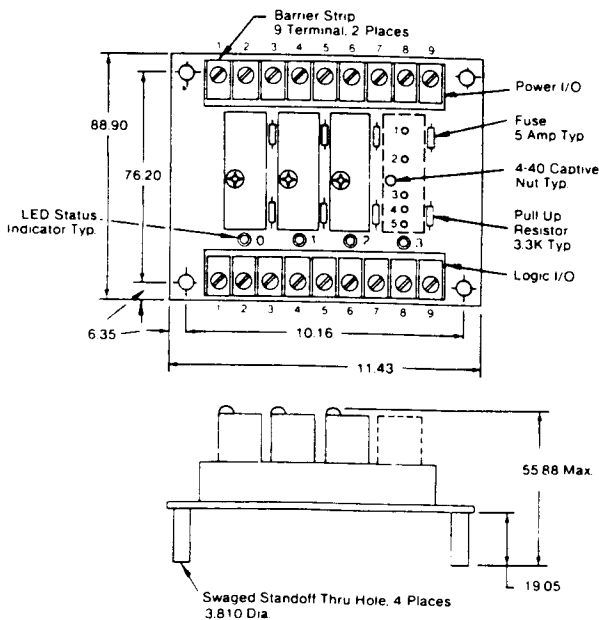

MS-4H Schematic

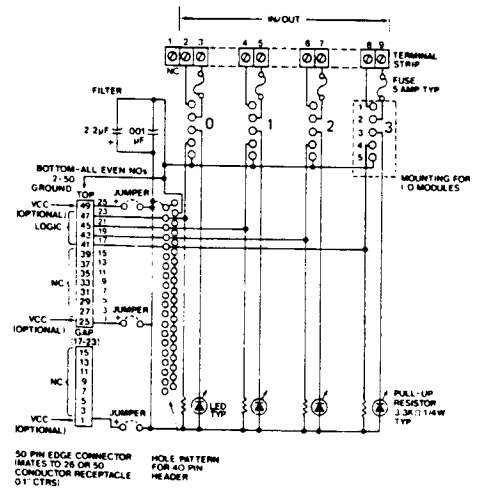

MS-4H Mounting Board

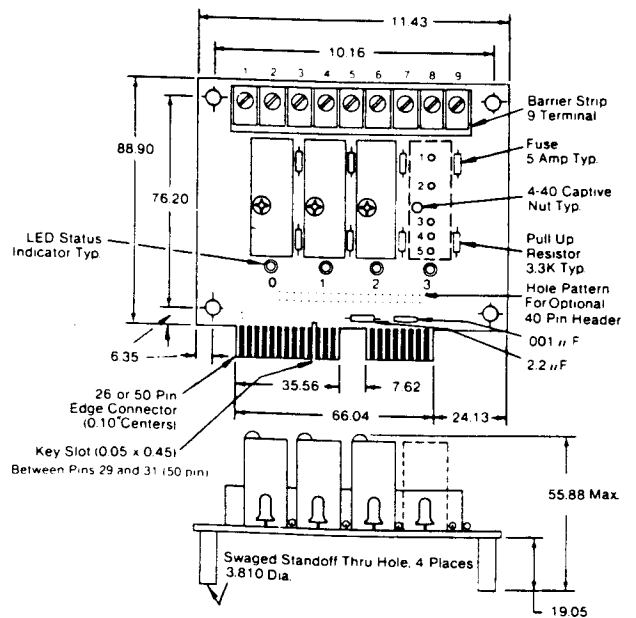

Recommended connectors and suppliers

26 pin card edge connector (T&B/Ansley P/N 609-2615M or equivalent).
40-pin header (T&B/Ansley P/N 609-4037E or equiv.) with matching female socket connector (T&B/Ansley P/N 609-4030 or equivalent).
50-pin card edge connector (T&B/Ansley P/N 609-5015M or equivalent).

All dimensions in millimetres

MS-8H Schematic

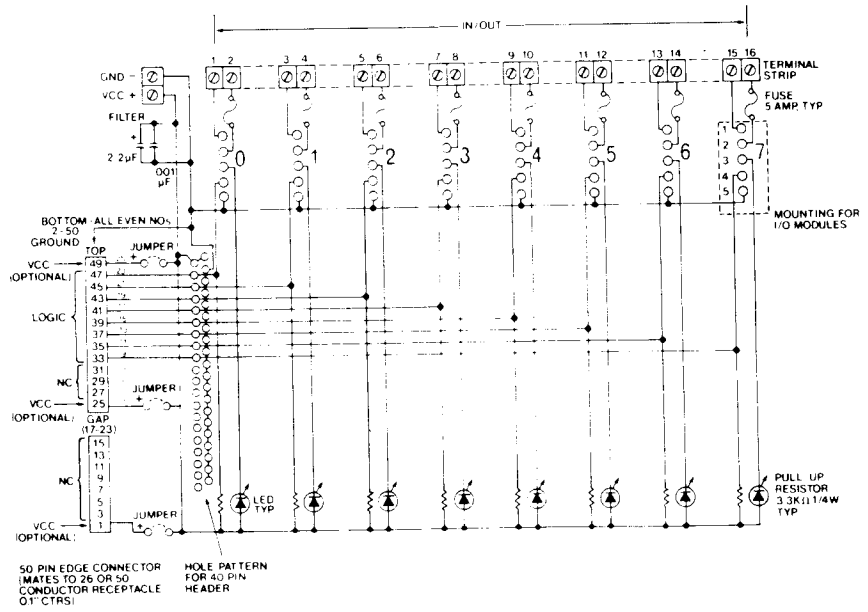

MS-8H Mounting Board

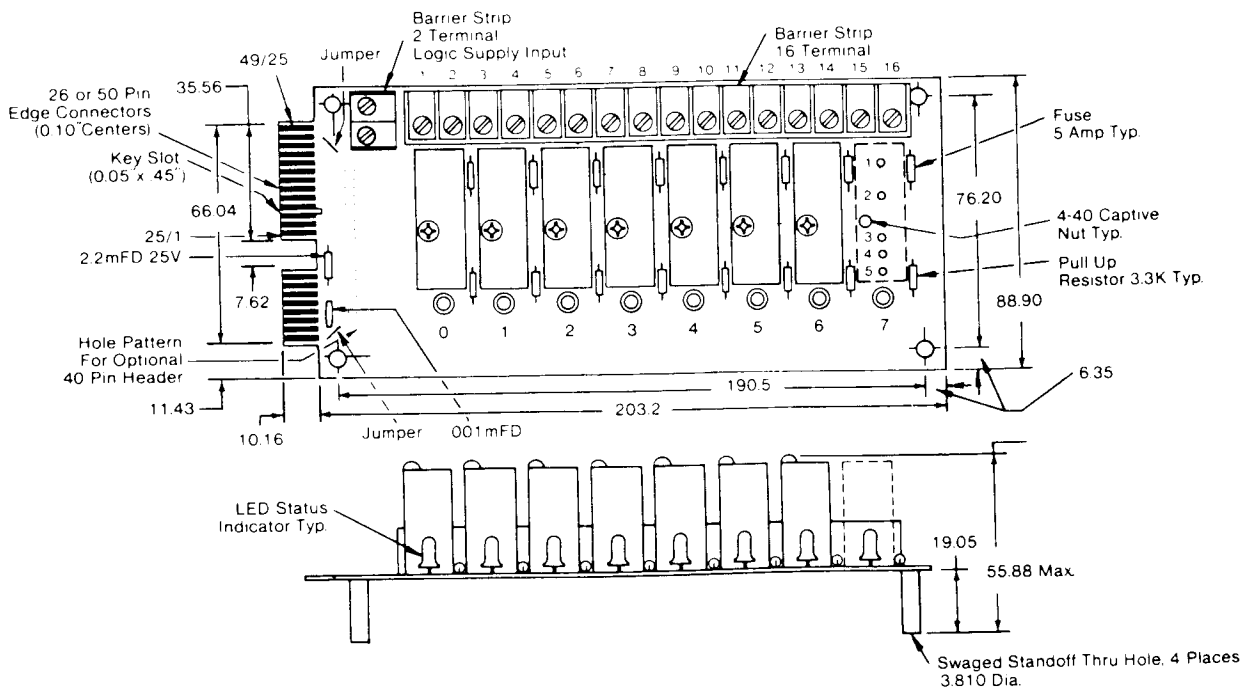

All dimensions in millimetres

MS-16H Schematic

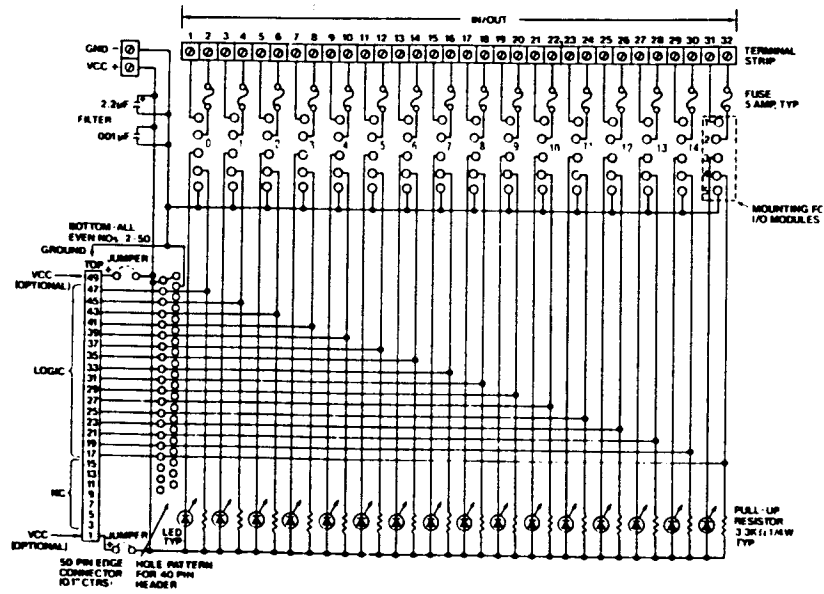

MS-16H Mounting Board

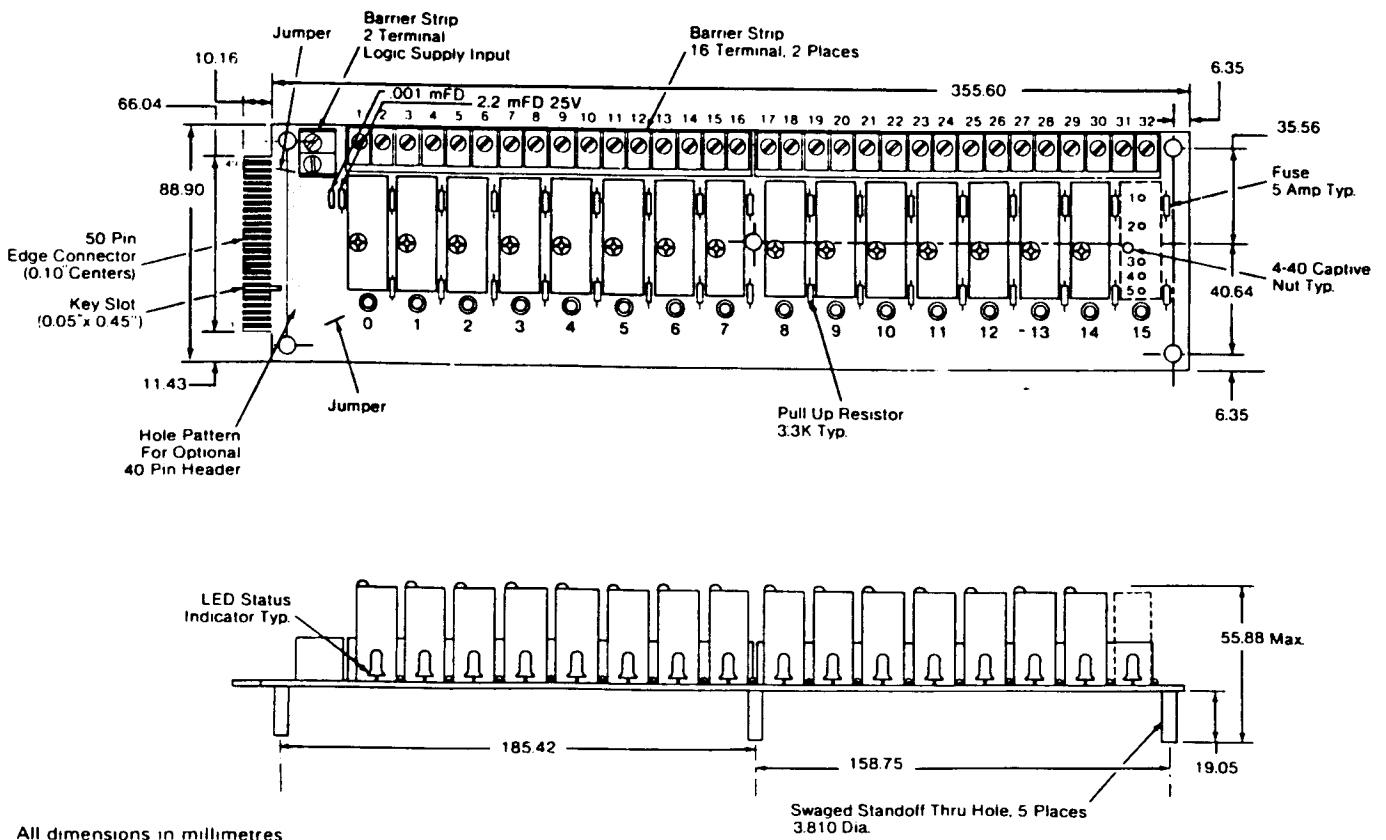

All dimensions in millimetres