

## OMNIMATE Power - series LL LLFS 7.50/06/90V 5.0SN BK BX

**Weidmüller Interface GmbH & Co. KG**  
Klingenbergstraße 16  
D-32758 Detmold  
Germany  
Fon: +49 5231 14-0  
Fax: +49 5231 14-292083  
www.weidmueller.com

### Product image

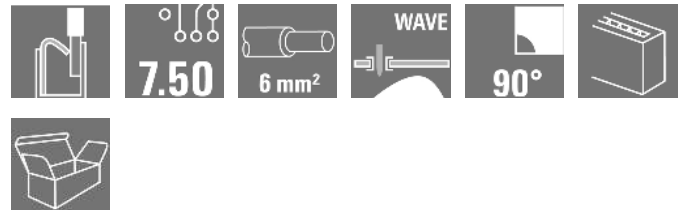

**The sturdy, direct connection for extreme current and voltage requirements in all power electronics applications such as solar inverters, frequency converters, servo-controllers and power supplies.**

### General ordering data

|              |  |
|--------------|--|
| Type         | LLFS 7.50/06/90V 5.0SN BK BX   |
| Order No.    | <a href="#">2473040000</a>   |
| Version      | Printed circuit board terminals, 7.50 mm, No. of poles: 6, 90°, Solder pin length (l): 5 mm, tinned, black, PUSH IN without actuator, Clamping range, max.: 6 mm², Box |
| GTIN (EAN)   | 4050118658156  |
| Qty.         | 50 pc(s).  |
| Product data | IEC: 1000 V / 41 A / 0.5 - 6 mm²<br>UL: 600 V / 37 A / AWG 24 - AWG 8  |
| Packaging    | Box  |

**OMNIMATE Power - series LL**  
**LLFS 7.50/06/90V 5.0SN BK BX**

**Weidmüller Interface GmbH & Co. KG**  
 Klingenbergstraße 16  
 D-32758 Detmold  
 Germany  
 Fon: +49 5231 14-0  
 Fax: +49 5231 14-292083  
 www.weidmueller.com

**Technical data**
**Dimensions and weights**

|                          |            |                 |            |
|--------------------------|------------|-----------------|------------|
| Width                    | 46 mm      | Width (inches)  | 1.811 inch |
| Height                   | 30.56 mm   | Height (inches) | 1.203 inch |
| Height of lowest version | 25.56 mm   | Depth           | 20.05 mm   |
| Depth (inches)           | 0.789 inch | Net weight      | 24.92 g    |

**System parameters**

|  |                            |  |                          |
|--|----------------------------|--|--------------------------|
| Product family                             | OMNIMATE Power - series LL | Wire connection method                       | PUSH IN without actuator |
| Mounting onto the PCB                      | THT solder connection      | Conductor outlet direction                   | 90°                      |
| Pitch in mm (P)                            | 7.5 mm                     | Pitch in inches (P)                          | 0.295 inch               |
| No. of poles                               | 6                          | Fitted by customer                           | No                       |
| Solder pin length (l)                      | 5 mm                       | Solder pin dimensions                        | d = 1.5 mm               |
| Solder eyelet hole diameter (D)            | 2 mm                       | Solder eyelet hole diameter tolerance (D)+   | 0,1 mm                   |
| Number of solder pins per pole             | 1                          | Stripping length                             | 12 mm                    |
| L1 in mm                                   | 37.5 mm                    | L1 in inches                                 | 1.475 inch               |
| Touch-safe protection acc. to DIN VDE 0470 | IP 20                      | Touch-safe protection acc. to DIN VDE 57 106 | Safe from finger touch   |

**Material data**

|                                      |                    |                                       |        |
|--------------------------------------|--------------------|---------------------------------------|--------|
| Insulating material                  | Wemid (PA)         | Colour                                | black  |
| Colour chart (similar)               | RAL 9011           | Insulating material group             | I      |
| Insulation strength                  | $\geq 10^8 \Omega$ | UL 94 flammability rating             | V-0    |
| Contact material                     | E-Cu               | Contact surface                       | tinned |
| Layer structure of solder connection | 4-10 $\mu$ Sn matt | Storage temperature, min.             | -40 °C |
| Storage temperature, max.            | 85 °C              | Max. relative humidity during storage | 80 %   |
| Operating temperature, min.          | -40 °C             | Operating temperature, max.           | 120 °C |

**Conductors suitable for connection**

|   |                      |
|---|----------------------|
| Clamping range, min.                            | 0.25 mm <sup>2</sup> |
| Clamping range, max.                            | 6 mm <sup>2</sup>    |
| Solid, min. H05(07) V-U                         | 0.5 mm <sup>2</sup>  |
| Solid, max. H05(07) V-U                         | 6 mm <sup>2</sup>    |
| Flexible, min. H05(07) V-K                      | 0.5 mm <sup>2</sup>  |
| Flexible, max. H05(07) V-K                      | 6 mm <sup>2</sup>    |
| w. plastic collar ferrule, DIN 46228 pt 4, min. | 0.25 mm <sup>2</sup> |
| w. plastic collar ferrule, DIN 46228 pt 4, max. | 6 mm <sup>2</sup>    |
| w. wire end ferrule, DIN 46228 pt 1, min.       | 0.25 mm <sup>2</sup> |
| w. wire end ferrule, DIN 46228 pt 1, max.       | 6 mm <sup>2</sup>    |

**OMNIMATE Power - series LL**  
**LLFS 7.50/06/90V 5.0SN BK BX**

**Weidmüller Interface GmbH & Co. KG**  
 Klingenbergstraße 16  
 D-32758 Detmold  
 Germany  
 Fon: +49 5231 14-0  
 Fax: +49 5231 14-292083  
 www.weidmueller.com

**Technical data**

|  |  |                              |                            |
|--|--|------------------------------|----------------------------|
| Clampable conductor                    | Cross-section for conductor connection | Type                         | fine-wired                 |
|  |  | nominal                      | 0.5 mm <sup>2</sup>        |
| wire end ferrule                       | Cross-section for conductor connection | Stripping length             | nominal 14 mm              |
|  |  | Recommended wire-end ferrule | <a href="#">1076980000</a> |
| Cross-section for conductor connection | Cross-section for conductor connection | Type                         | fine-wired                 |
|  |  | nominal                      | 1 mm <sup>2</sup>          |
| wire end ferrule                       | Cross-section for conductor connection | Stripping length             | nominal 15 mm              |
|  |  | Recommended wire-end ferrule | <a href="#">9025930000</a> |
| Cross-section for conductor connection | Cross-section for conductor connection | Type                         | fine-wired                 |
|  |  | nominal                      | 1.5 mm <sup>2</sup>        |
| wire end ferrule                       | Cross-section for conductor connection | Stripping length             | nominal 15 mm              |
|  |  | Recommended wire-end ferrule | <a href="#">9019140000</a> |
|  |  | Stripping length             | nominal 12 mm              |
|  |  | Recommended wire-end ferrule | <a href="#">9004060000</a> |
| Cross-section for conductor connection | Cross-section for conductor connection | Type                         | fine-wired                 |
|  |  | nominal                      | 0.75 mm <sup>2</sup>       |
| wire end ferrule                       | Cross-section for conductor connection | Stripping length             | nominal 14 mm              |
|  |  | Recommended wire-end ferrule | <a href="#">9025910000</a> |
| Cross-section for conductor connection | Cross-section for conductor connection | Type                         | fine-wired                 |
|  |  | nominal                      | 2.5 mm <sup>2</sup>        |
| wire end ferrule                       | Cross-section for conductor connection | Stripping length             | nominal 14 mm              |
|  |  | Recommended wire-end ferrule | <a href="#">9019170000</a> |
|  |  | Stripping length             | nominal 12 mm              |
|  |  | Recommended wire-end ferrule | <a href="#">0186100000</a> |
| Cross-section for conductor connection | Cross-section for conductor connection | Type                         | fine-wired                 |
|  |  | nominal                      | 4 mm <sup>2</sup>          |
| wire end ferrule                       | Cross-section for conductor connection | Stripping length             | nominal 12 mm              |
|  |  | Recommended wire-end ferrule | <a href="#">0244100000</a> |
|  |  | Stripping length             | nominal 14 mm              |
|  |  | Recommended wire-end ferrule | <a href="#">9019200000</a> |
| Cross-section for conductor connection | Cross-section for conductor connection | Type                         | fine-wired                 |
|  |  | nominal                      | 6 mm <sup>2</sup>          |
| wire end ferrule                       | Cross-section for conductor connection | Stripping length             | nominal 14 mm              |
|  |  | Recommended wire-end ferrule | <a href="#">0533500000</a> |
|  |  | Stripping length             | nominal 12 mm              |
|  |  | Recommended wire-end ferrule | <a href="#">0191900000</a> |
| Cross-section for conductor connection | Cross-section for conductor connection | Type                         | fine-wired                 |
|  |  | nominal                      | 10 mm <sup>2</sup>         |
| wire end ferrule                       | Cross-section for conductor connection | Stripping length             | nominal 12 mm              |
|  |  | Recommended wire-end ferrule | <a href="#">0282900000</a> |
| Max. clamping range                    | 6 mm <sup>2</sup>                      |                              |                            |

**OMNIMATE Power - series LL  
LLFS 7.50/06/90V 5.0SN BK BX**

**Weidmüller Interface GmbH & Co. KG**  
Klingenbergstraße 16  
D-32758 Detmold  
Germany  
Fon: +49 5231 14-0  
Fax: +49 5231 14-292083  
www.weidmueller.com

**Technical data****Rated data acc. to IEC**

|   |                                  |   |         |
|---|----------------------------------|---|---------|
| tested acc. to standard   | In accordance with IEC 60947-7-1 | Rated current, min. no. of poles (Tu=20°C)                            | 41 A    |
| Rated current, max. no. of poles (Tu=20°C)                                | 34 A                             | Rated current, min. no. of poles (Tu=40°C)                            | 37 A    |
| Rated current, max. no. of poles (Tu=40°C)                                | 29 A                             | Rated voltage for surge voltage class / pollution degree II/2         | 1,000 V |
| Rated voltage for surge voltage class / pollution degree III/2            | 1,000 V                          | Rated voltage for surge voltage class / pollution degree III/3        | 1,000 V |
| Rated impulse voltage for surge voltage class/ pollution degree II/2      | 8 kV                             | Rated impulse voltage for surge voltage class/ pollution degree III/2 | 8 kV    |
| Rated impulse voltage for surge voltage class/ contamination degree III/3 | 8 kV                             |   |         |

**Rated data acc. to CSA**

|                                   |        |                                   |       |
|-----------------------------------|--------|-----------------------------------|-------|
| Rated voltage (Use group B / CSA) | 600 V  | Rated voltage (Use group C / CSA) | 600 V |
| Rated voltage (Use group D / CSA) | 600 V  | Rated current (Use group B / CSA) | 37 A  |
| Rated current (Use group C / CSA) | 37 A   | Rated current (Use group D / CSA) | 5 A   |
| Wire cross-section, AWG, min.     | AWG 24 | Wire cross-section, AWG, max.     | AWG 8 |

**Rated data acc. to UL 1059**

|                                       |   |                                       |        |
|---------------------------------------|---|---------------------------------------|--------|
| Institute (cURus)                     |  | Certificate No. (cURus)               | E60693 |
| Rated voltage (Use group B / UL 1059) | 600 V   | Rated voltage (Use group C / UL 1059) | 600 V  |
| Rated voltage (Use group D / UL 1059) | 600 V   | Rated current (Use group B / UL 1059) | 37 A   |
| Rated current (Use group C / UL 1059) | 37 A  | Rated current (Use group D / UL 1059) | 5 A    |
| Wire cross-section, AWG, min.         | AWG 24  | Wire cross-section, AWG, max.         | AWG 8  |
| Reference to approval values          | Specifications are maximum values, details - see approval certificate.              |                                       |        |

**Packing**

|           |        |            |        |
|-----------|--------|------------|--------|
| Packaging | Box    | VPE length | 295 mm |
| VPE width | 210 mm | VPE height | 45 mm  |

**Classifications**

|            |             |            |             |
|------------|-------------|------------|-------------|
| ETIM 3.0   | EC001284    | ETIM 4.0   | EC002643    |
| ETIM 5.0   | EC002643    | ETIM 6.0   | EC002643    |
| eClass 6.2 | 27-26-11-01 | eClass 9.0 | 27-44-04-01 |
| eClass 9.1 | 27-44-04-01 |            |             |

**Data sheet**

**OMNIMATE Power - series LL  
LLFS 7.50/06/90V 5.0SN BK BX**

**Weidmüller Interface GmbH & Co. KG**  
Klingenbergstraße 16  
D-32758 Detmold  
Germany  
Fon: +49 5231 14-0  
Fax: +49 5231 14-292083  
www.weidmueller.com

**Technical data**

**Notes**

- |       |  |
|-------|--|
| Notes | <ul style="list-style-type: none"> <li>• Additional colours on request</li> <br/> <li>• Rated current related to rated cross-section &amp; min. No. of poles.</li> <br/> <li>• Wire end ferrule without plastic collar to DIN 46228/1</li> <br/> <li>• Wire end ferrule with plastic collar to DIN 46228/4</li> <br/> <li>• P on drawing = pitch</li> <br/> <li>• Rated data refer only to the component itself. Clearance and creepage distances to other components are to be designed in accordance with the relevant application standards.</li> <br/> <li>• The test point can only be used as potential-pickup point.</li> </ul> |
|-------|--|

|                |  |
|----------------|--|
| IPC conformity | Conformity: The products are developed, manufactured and delivered according international recognized standards and norms and comply with the assured properties in the data sheet resp. fulfill decorative properties in accordance with IPC-A-610 "Class 2". Further claims on the products can be evaluated on request. |
|----------------|--|

**Approvals**

Approvals



**Downloads**

|   |   |
|---|---|
| Approval/Certificate/Document of Conformity | <a href="#">Declaration of the Manufacturer</a> |
| Engineering Data                            | <a href="#">STEP</a><br><a href="#">STEP</a>    |
| Motion controllers white paper              | <a href="#">Download Whitepaper</a>             |
| White Paper UL 600 V                        | <a href="#">Download Whitepaper</a>             |

**OMNIMATE Power - series LL  
LLFS 7.50/06/90V 5.0SN BK BX**

**Weidmüller Interface GmbH & Co. KG**  
Klingenbergstraße 16  
D-32758 Detmold  
Germany  
Fon: +49 5231 14-0  
Fax: +49 5231 14-292083  
www.weidmueller.com

**Drawings**

**Dimensional drawing**

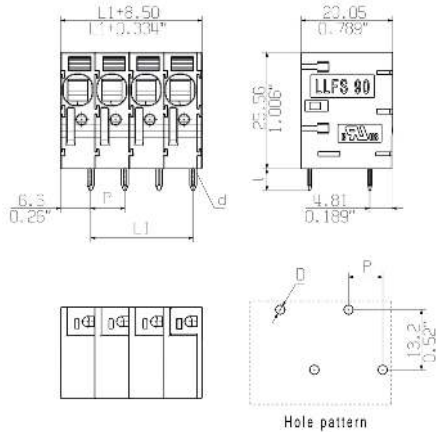

**Derating curve**

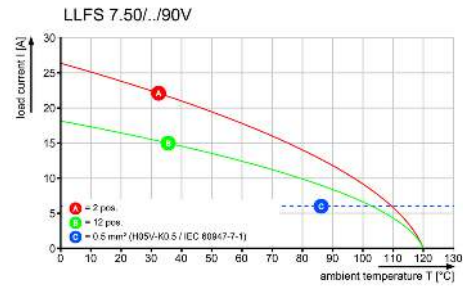

**Derating curve**

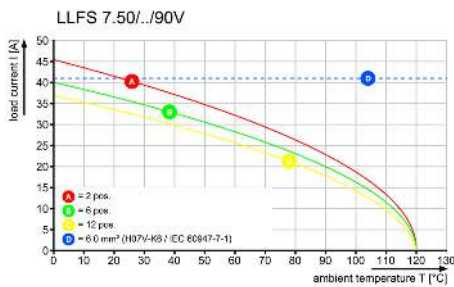

**Product benefits**

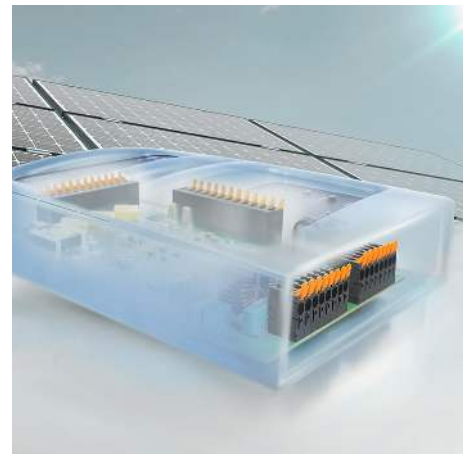

Power up to UL 600 V  
Offset solder pins

**Product benefits**

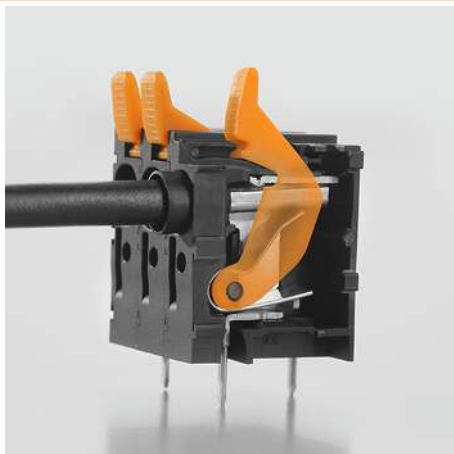

Tool-free wiring  
Top contact security

General customer drawing, topical version only if required

The reproduction, distribution and utilization of this document as well as the communication of its contents to others without explicit authorization is prohibited. Offenders will be held liable for the payment of damages. Weidmüller exclusively reserves the right to file for patents, utility models or designs.

© Weidmüller Interface GmbH & Co. KG

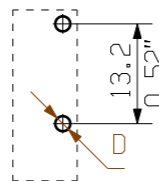
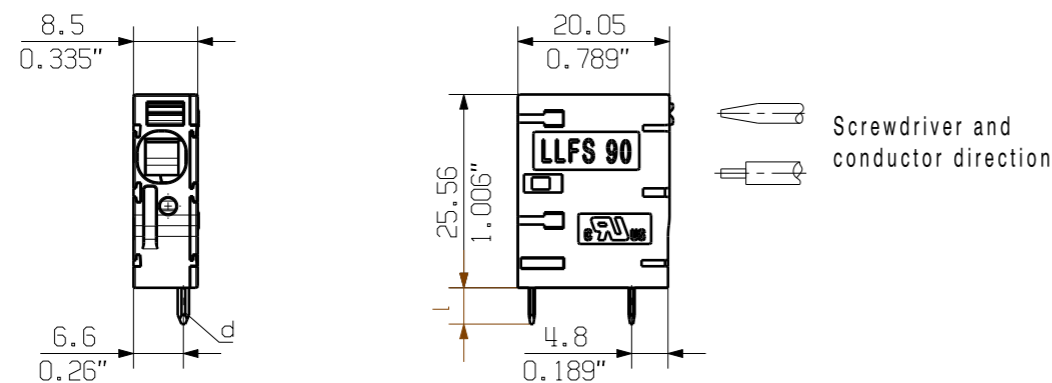

Hole pattern

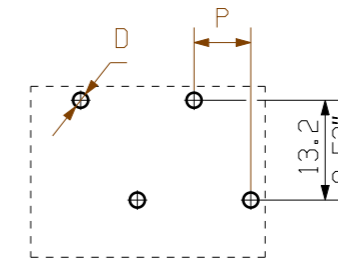
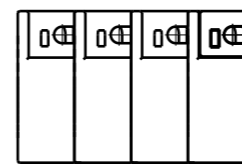
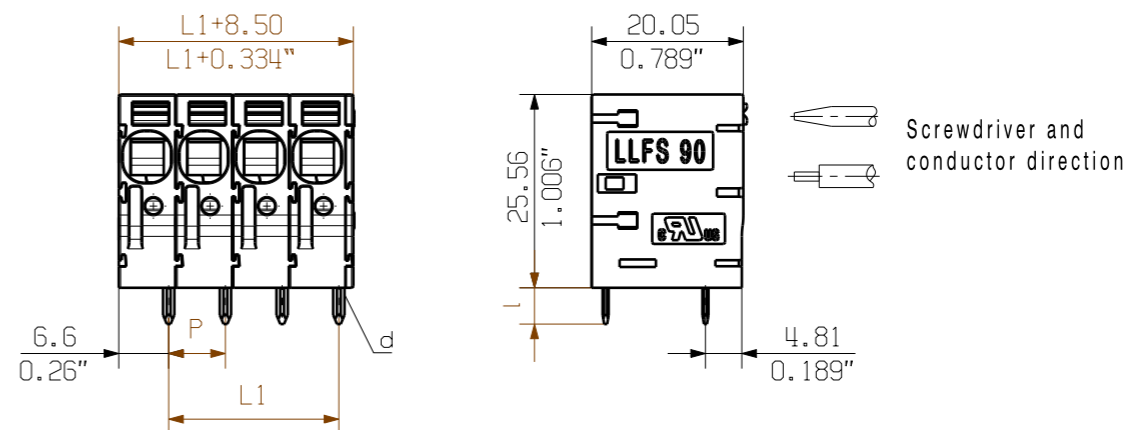
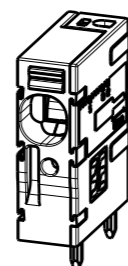

Hole pattern

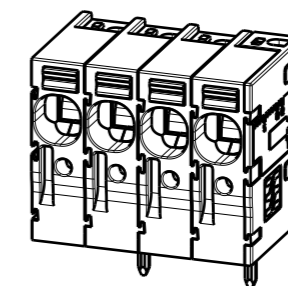

|         |         |           |
|---------|---------|-----------|
| 12      | 82.50   | 3.248     |
| 11      | 75.00   | 2.953     |
| 10      | 67.50   | 2.657     |
| 9       | 60.00   | 2.362     |
| 8       | 52.50   | 2.067     |
| 7       | 45.00   | 1.772     |
| 6       | 37.50   | 1.476     |
| 5       | 30.00   | 1.181     |
| 4       | 22.50   | 0.886     |
| 3       | 15.00   | 0.591     |
| 2       | 7.50    | 0.295     |
| n Poles | L1 [mm] | L1 [inch] |

P = 7.50  
0.295" (Pitch)  
D = Ø2 +0.1  
0.079"  
d = 1.5x0.8  
0.059"x0.031"  
l = 5.0 +0.2 -0.6  
0.197"

For the mounting of PCBs, it should be noted that the rated data relates only to the PCB components alone. The necessary creepage and clearance paths must be observed in connection with the respective applicant in accordance to IEC 60664-1 (VDE 0110). The current-carrying capacity and pitch tolerance is to be determined according to DIN IEC 60326-3 very fine.

Weidmüller PCB components are tested to the IEC 60947-7-4 standard, and are valid for its field of application. Provided that the components are used to the intended purpose, all requirements with respect to the occurring of electrical, mechanical, thermic and corrosive stress will be satisfied.

|                                       |  |   |            |           |  |  |  |
|---------------------------------------|--|---|------------|-----------|--|--|--|
| General tolerance:<br>DIN ISO 2768-mK |  | 104820/4<br>10.07.18 WU_M   |            | 00        |  | Cat.no.: .   |  |
|                                       |  | Modification  |            |           |  | <b>3 61340</b>   |  |
|                                       |  | Drawing no. <b>3 61340</b> Issue no. <b>04</b><br>Sheet 01 of 01 sheets |            |           |  |  |  |
|                                       |  | Drawn   | 04.07.2016 | KRECHT_M  |  | <b>LLFS 7.50/.../90 ...</b><br>LEITERPLATTENKLEMME<br>PCB TERMINAL |  |
|                                       |  | Responsible   |            | WRIGHT_ST |  |  |  |
|                                       |  | Checked   | 16.07.2018 | ZHOU_N    |  |  |  |
| Scale: 1/1                            |  | Approved  |            | XU_S      |  | Product file: LLF 7.50   |  |
| Supersedes: .                         |  |   |            |           |  | 7416   |  |

## Recommended wave soldering profiles

**Weidmüller Interface GmbH & Co. KG**  
 Klängenbergstraße 16  
 D-32758 Detmold  
 Germany  
 Fon: +49 5231 14-0  
 Fax: +49 5231 14-292083  
 www.weidmueller.com

### Single Wave:

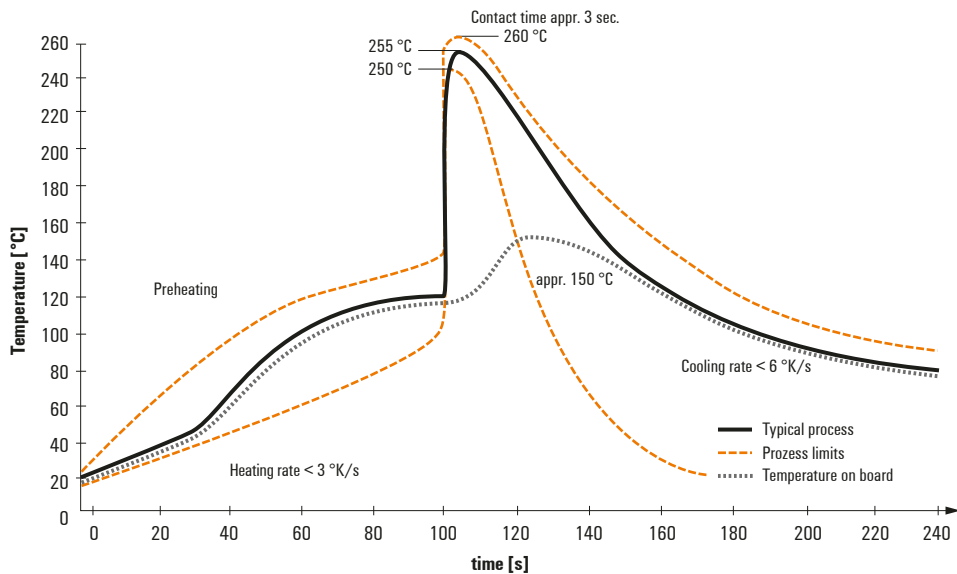

### Double Wave:

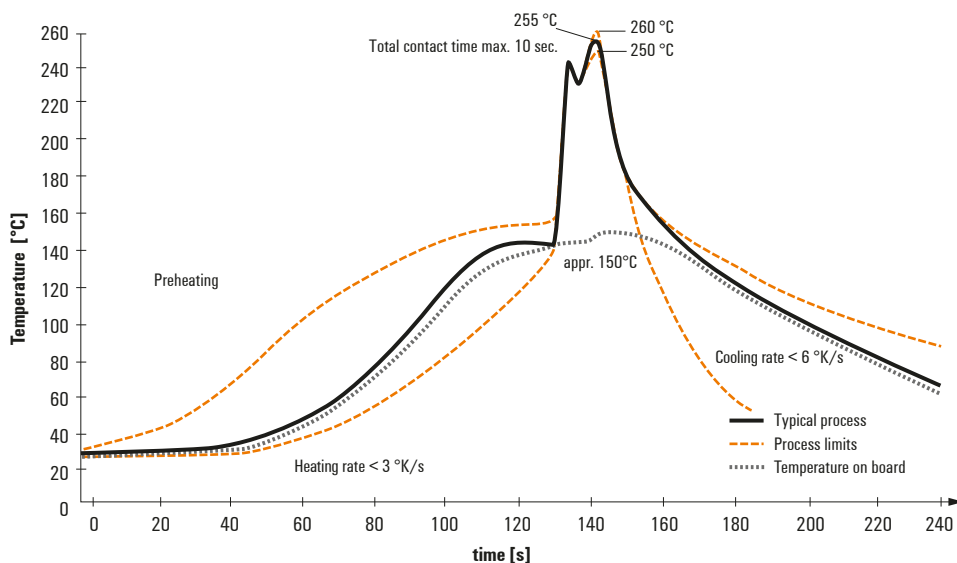

### Wave soldering profiles

Wired connection elements should be processed in accordance with the DIN EN 61760-1 standard. We have included two recommendations for practical wave soldering profiles, with which Weidmüller PCB terminals and connectors are qualified.

When choosing a suitable profile for your application, the following factors also need to be considered:

- PCB thickness
- Proportion of Cu in the layers
- Single/double-sided assembly
- Product range
- Heating and cooling rates

The single and double wave profiles each indicate the recommended operating range, including the maximum soldering temperature of 260°C. In practice, the maximum soldering temperature is quite often well below the above maximum profile.