



MAXIM

500MHz, Low-Power Op Amps

MAX4100/MAX4101

General Description

The MAX4100/MAX4101 op amps combine ultra-high-speed performance with low-power operation. The MAX4100 is compensated for unity-gain stability, while the MAX4101 is compensated for stability in applications with a closed-loop gain (A_{VCL}) of 2V/V or greater.

The MAX4100/MAX4101 require only 5mA of supply current while delivering a 500MHz unity-gain bandwidth (MAX4100) or a 200MHz -3dB bandwidth (MAX4101) with a 250V/ μ s slew rate.

These high-speed op amps have a wide output voltage swing of $\pm 3.5V$ and a high current-drive capability of 80mA.

Applications

- Video Cable Driver
- Ultrasound
- Gamma Cameras
- Portable Instruments
- Active Filters
- ADC Buffers

Features

- ◆ 500MHz Unity-Gain Bandwidth (MAX4100)
200MHz -3dB Bandwidth ($A_{VCL} = 2V/V$, MAX4101)
- ◆ 65MHz 0.1dB Gain Flatness (MAX4100)
- ◆ 250V/ μ s Slew Rate
- ◆ 0.06%/0.04° Differential Gain/Phase
- ◆ High Output Drive: 80mA
- ◆ Low Power: 5mA Supply Current
- ◆ Fast Settling Time:
18ns to 0.1%
35ns to 0.01%

Ordering Information

PART	TEMP. RANGE	PIN-PACKAGE
MAX4100ESA	-40°C to +85°C	8 SO
MAX4100EUA	-40°C to +85°C	8 μ MAX*
MAX4101ESA	-40°C to +85°C	8 SO

* Contact factory for availability of μ MAX package.

Typical Application Circuit

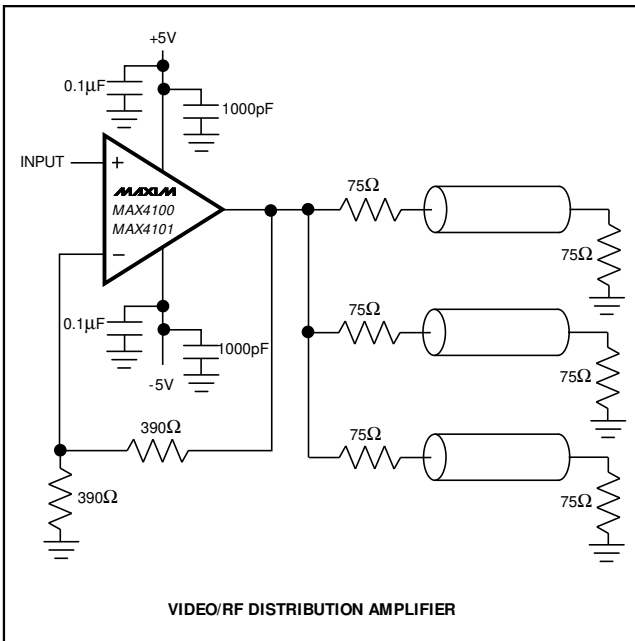

Pin Configuration

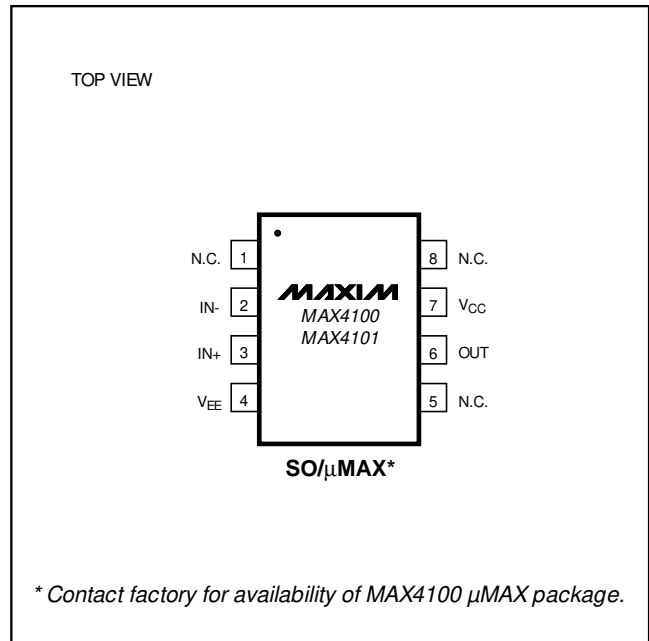

500MHz, Low-Power Op Amps

MAX4100/MAX4101

ABSOLUTE MAXIMUM RATINGS

Power-Supply Voltage (V_{CC} , V_{EE}) $\pm 6V$
 Voltage on Any Pin to Ground or Any Other Pin V_{CC} to V_{EE}
 Short-Circuit Duration (V_{OUT} to GND)Indefinite
 Continuous Power Dissipation ($T_A = +70^\circ C$)
 SO (derate 5.88mW/ $^\circ C$ above $+70^\circ C$)471mW
 μ MAX (derate 4.10mW/ $^\circ C$ above $+70^\circ C$)330mW

Operating Temperature Ranges

MAX4100E_A/MAX4101E_A $-40^\circ C$ to $+85^\circ C$
 Storage Temperature Range $-65^\circ C$ to $+160^\circ C$
 Lead Temperature (soldering, 10sec) $+300^\circ C$

Stresses beyond those listed under "Absolute Maximum Ratings" may cause permanent damage to the device. These are stress ratings only, and functional operation of the device at these or any other conditions beyond those indicated in the operational sections of the specifications is not implied. Exposure to absolute maximum rating conditions for extended periods may affect device reliability.

ELECTRICAL CHARACTERISTICS

($V_{CC} = 5V$, $V_{EE} = -5V$, $T_A = T_{MIN}$ to T_{MAX} , unless otherwise noted. Typical values are at $T_A = +25^\circ C$.)

PARAMETER	SYMBOL	CONDITIONS	MIN	TYP	MAX	UNITS
DC SPECIFICATIONS						
Input Offset Voltage	V_{OS}	$V_{OUT} = 0V$		1	8	mV
Input Offset Voltage Drift	TCV_{OS}	$V_{OUT} = 0V$		15		$\mu V/^\circ C$
Input Bias Current	I_B	$V_{OUT} = 0V$, $V_{IN} = -V_{OS}$		3	9	μA
Input Offset Current	I_{OS}	$V_{OUT} = 0V$, $V_{IN} = -V_{OS}$		0.05	0.5	μA
Common-Mode Input Resistance	R_{INCM}	Either input		5		$M\Omega$
Common-Mode Input Capacitance	C_{INCM}	Either input		1		pF
Input Voltage Noise	e_n	$f = 100kHz$	MAX4100	8		nV/\sqrt{Hz}
			MAX4101	6		
Integrated Voltage Noise		$f = 1MHz$ to $100MHz$	MAX4100	100		μV_{RMS}
			MAX4101	75		
Input Current Noise	i_n	$f = 100kHz$	MAX4100	0.8		pA/\sqrt{Hz}
			MAX4101	0.8		
Integrated Current Noise		$f = 1MHz$ to $100MHz$	MAX4100	10		nA_{RMS}
			MAX4101	10		
Common-Mode Input Voltage	V_{CM}		-2.5		2.5	V
Common-Mode Rejection	CMR	$V_{CM} = \pm 2.5V$	75	90		dB
Power-Supply Rejection	PSR	$V_S = \pm 4.5V$ to $\pm 5.5V$	55	60		dB
Open-Loop Voltage Gain	A_{OL}	$V_{OUT} = \pm 2.0V$, $V_{CM} = 0V$	$R_L = \infty$	53	58	dB
			$R_L = 100\Omega$	51	56	
Quiescent Supply Current	I_{SY}	$V_{IN} = 0V$		5	6	mA
Output Voltage Swing	V_{OUT}	$R_L = \infty$	± 3.5	± 3.8		V
		$R_L = 100\Omega$	± 3.1	± 3.5		
Output Current		$R_L = 30\Omega$, $T_A = 0^\circ C$ to $+85^\circ C$	65	80		mA
Short-Circuit Output Current	I_{SC}	Short to ground or either supply voltage		90		mA

500MHz, Low-Power Op Amps

MAX4100/MAX4101

ELECTRICAL CHARACTERISTICS (continued)

($V_{CC} = 5V$, $V_{EE} = -5V$, $T_A = T_{MIN}$ to T_{MAX} , unless otherwise noted. Typical values are at $T_A = +25^\circ C$.)

PARAMETER	SYMBOL	CONDITIONS	MIN	TYP	MAX	UNITS
AC SPECIFICATIONS						
-3dB Bandwidth	BW	$V_{OUT} \leq 0.1V_{RMS}$	MAX4100	500		MHz
			MAX4101	200		
0.1dB Bandwidth		MAX4100, $A_{VCL} = +1$		65		MHz
		MAX4100, $A_{VCL} = +2$		50		
Slew Rate	SR	$-2V \leq V_{OUT} \leq 2V$		250		V/ μs
Settling Time	t_s	$-1V \leq V_{OUT} \leq 1V$, $R_L = 100\Omega$	to 0.1%	18		ns
			to 0.01%	35		
Rise/Fall Times	t_r, t_f	10% to 90%, $-2V \leq V_{OUT} \leq 2V$, $R_L = 100\Omega$		13		ns
		10% to 90%, $-50mV \leq V_{OUT} \leq 50mV$, $R_L = 100\Omega$		1.5		
Differential Gain	DG	$f = 3.58MHz$	MAX4100, $A_{VCL} = +1$	0.06		%
			MAX4101, $A_{VCL} = +2$	0.07		
Differential Phase	DP	$f = 3.58MHz$	MAX4100, $A_{VCL} = +1$	0.04		degrees
			MAX4101, $A_{VCL} = +2$	0.04		
Input Capacitance	C_{IN}			2		pF
Output Resistance	R_{OUT}	$f = 10MHz$	MAX4100, $A_{VCL} = +1$	0.8		Ω
			MAX4101, $A_{VCL} = +2$	0.3		
Spurious-Free Dynamic Range	SFDR	$f_C = 5MHz$, $V_{OUT} = 2V_{p-p}$	MAX4100, $A_{VCL} = +1$	-70		dBc
			MAX4101, $A_{VCL} = +2$	-65		
Third-Order Intercept		$f_C = 10MHz$, $A_{VCL} = +2$		36		dBm

Typical Operating Characteristics

($V_{CC} = 5V$, $V_{EE} = -5V$, $T_A = +25^\circ C$, unless otherwise noted.)

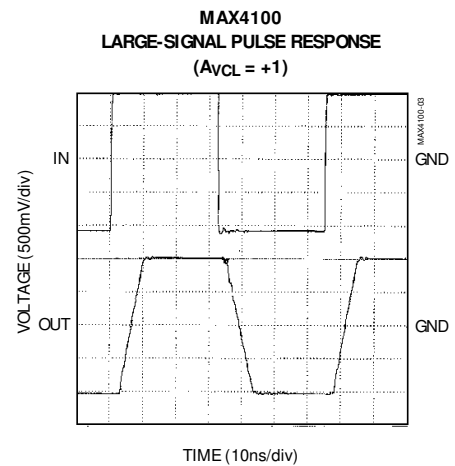
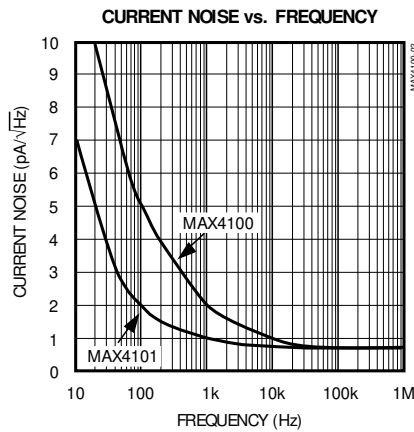
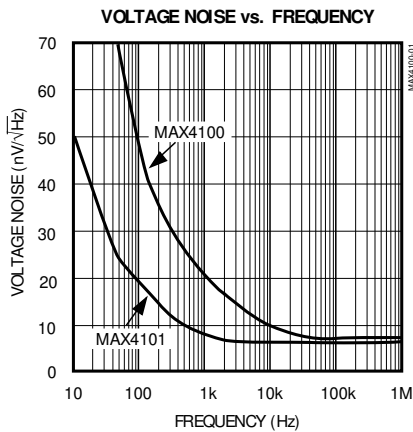

500MHz, Low-Power Op Amps

Typical Operating Characteristics (continued)

($V_{CC} = 5V$, $V_{EE} = -5V$, $T_A = +25^\circ C$, unless otherwise noted.)

MAX4100
LARGE-SIGNAL PULSE RESPONSE
($A_{vCL} = +5$)

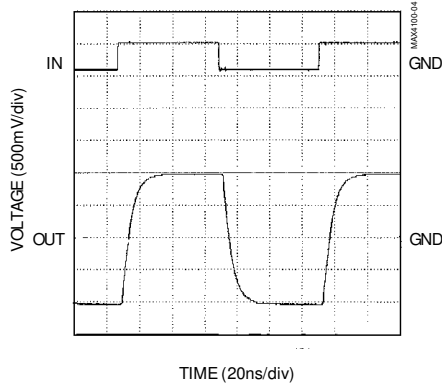

MAX4100
OUTPUT RESISTANCE vs. FREQUENCY

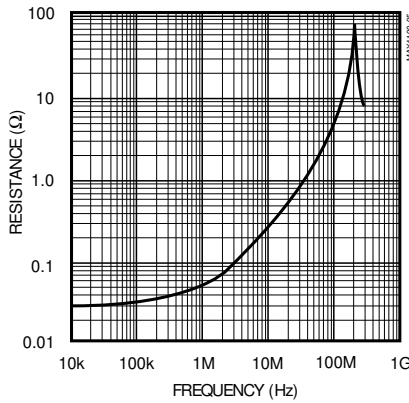

MAX4100
SMALL-SIGNAL PULSE RESPONSE
($A_{vCL} = +1$)

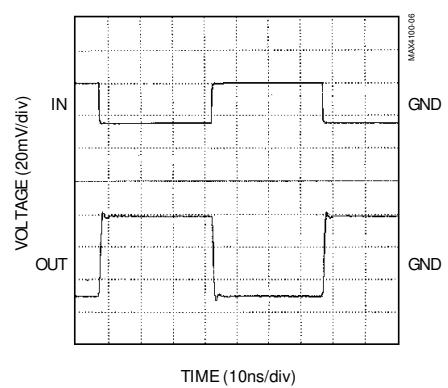

MAX4100
SMALL-SIGNAL PULSE RESPONSE
($A_{vCL} = +5$)

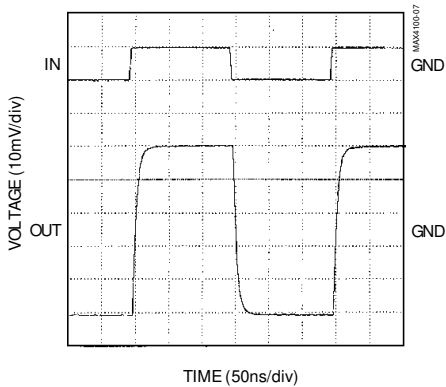

MAX4101
OUTPUT RESISTANCE vs. FREQUENCY

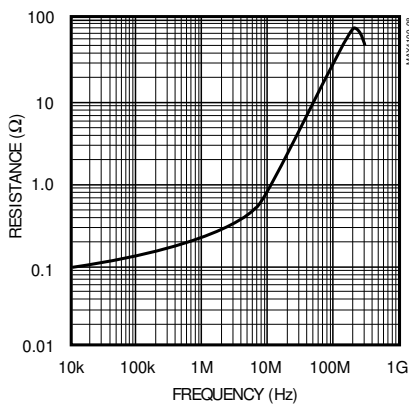

MAX4101
LARGE-SIGNAL PULSE RESPONSE
($A_{vCL} = +2$)

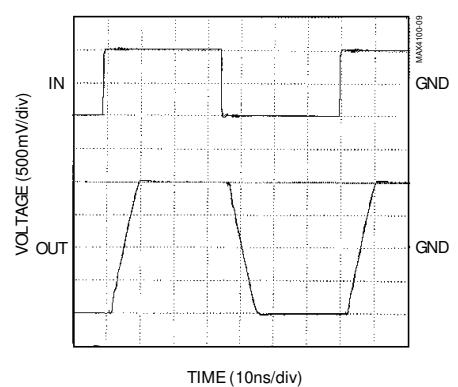

MAX4101
LARGE-SIGNAL PULSE RESPONSE
($A_{vCL} = +10$)

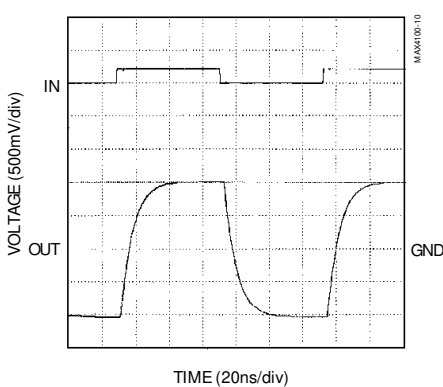

MAX4101
SMALL-SIGNAL PULSE RESPONSE
($A_{vCL} = +2$)

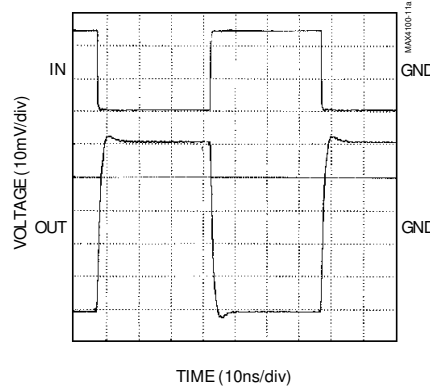

MAX4101
SMALL-SIGNAL PULSE RESPONSE
($A_{vCL} = +10$)

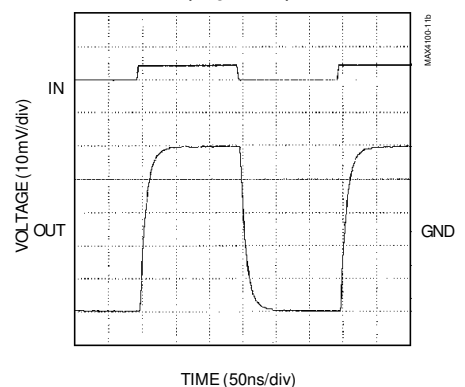

500MHz, Low-Power Op Amps

MAX4100/MAX4101

Typical Operating Characteristics (continued)

($V_{CC} = 5V$, $V_{EE} = -5V$, $T_A = +25^\circ C$, unless otherwise noted.)

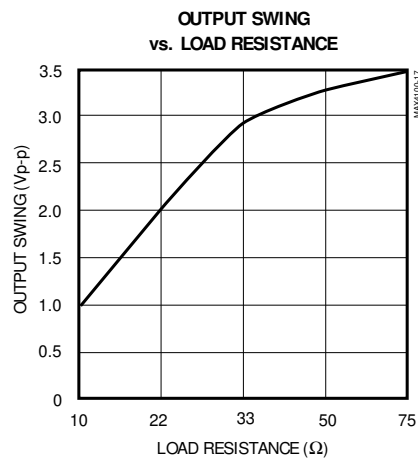
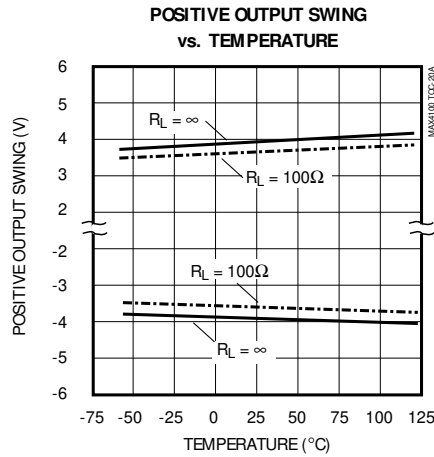
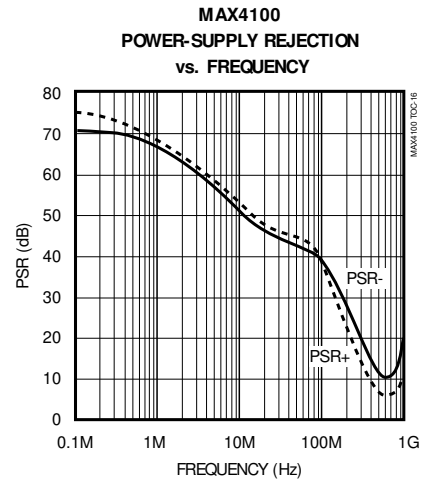
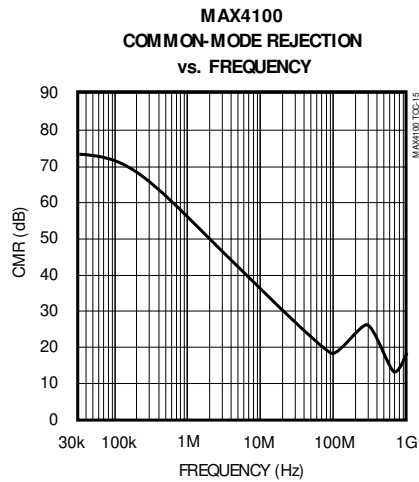
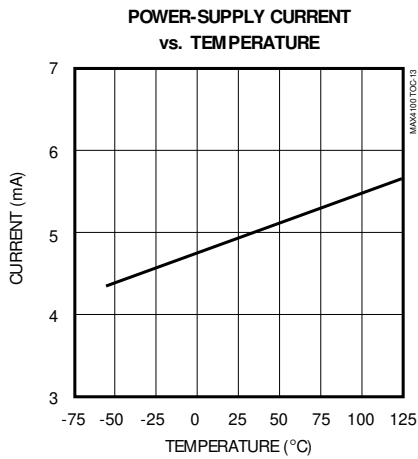
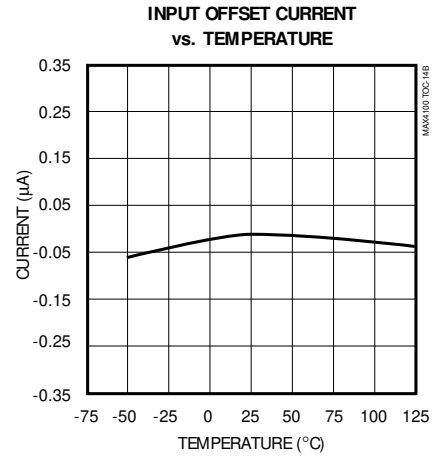
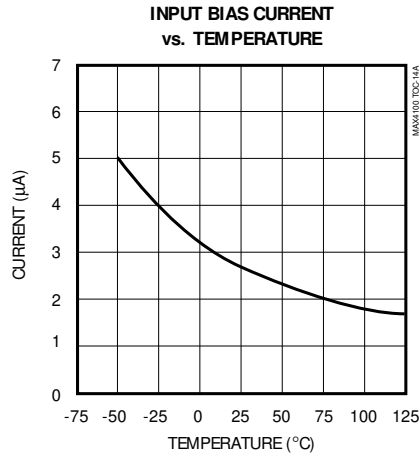
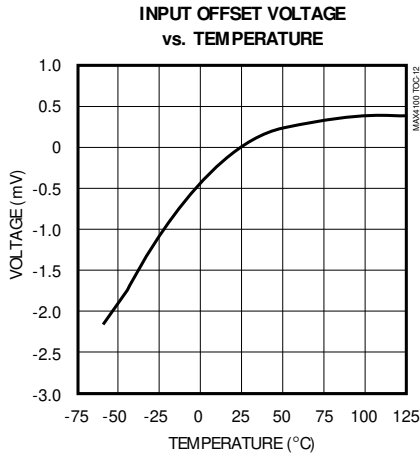

500MHz, Low-Power Op Amps

Typical Operating Characteristics (continued)

($V_{CC} = 5V$, $V_{EE} = -5V$, $T_A = +25^\circ C$, unless otherwise noted.)

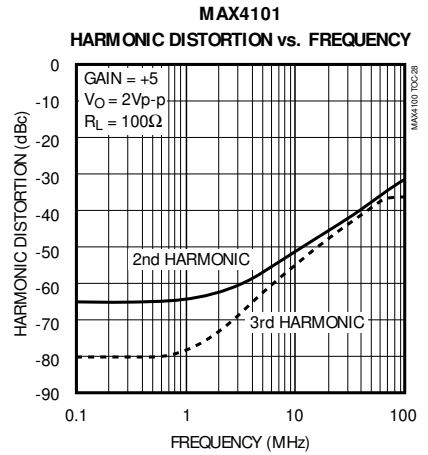
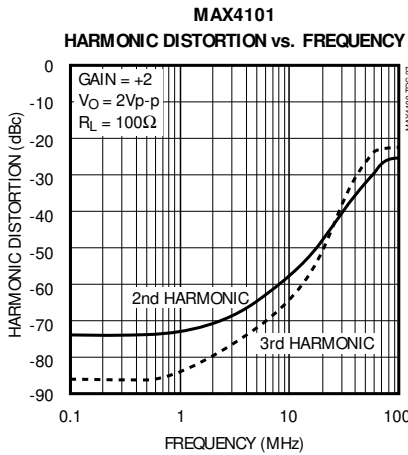
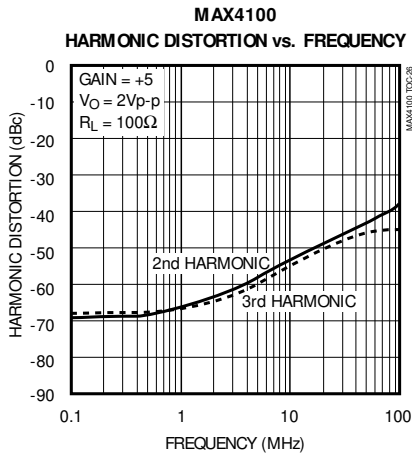
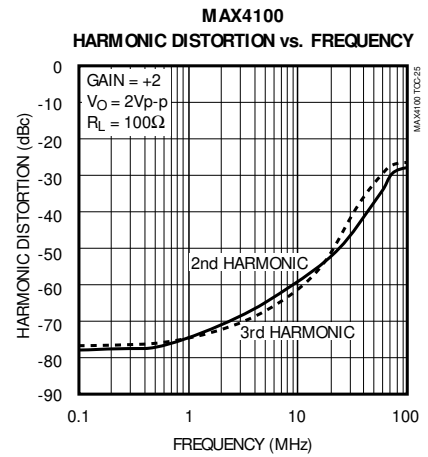
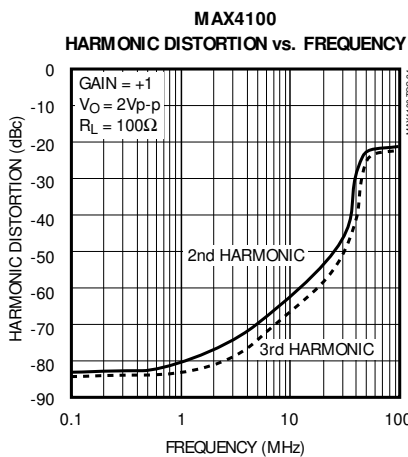
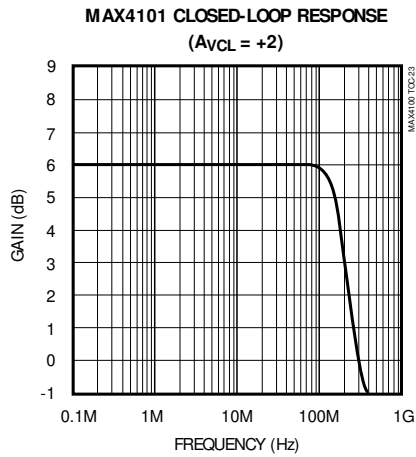
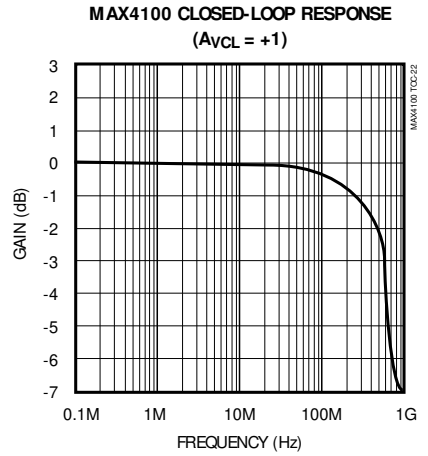
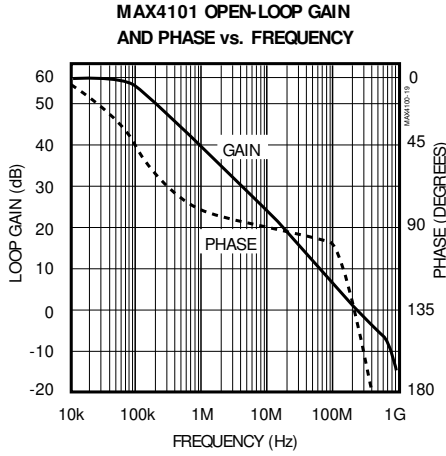
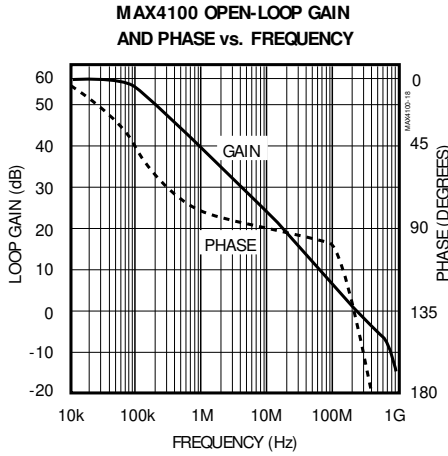

500MHz, Low-Power Op Amps

Typical Operating Characteristics (continued)

($V_{CC} = 5V$, $V_{EE} = -5V$, $T_A = +25^\circ C$, unless otherwise noted.)

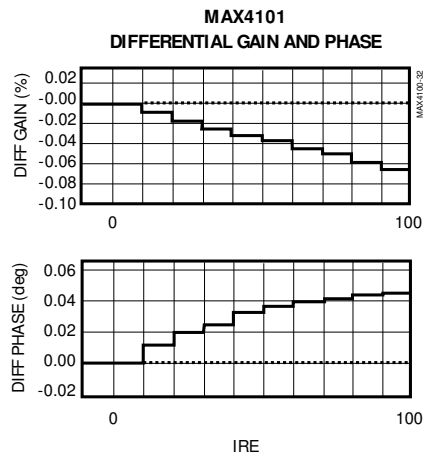
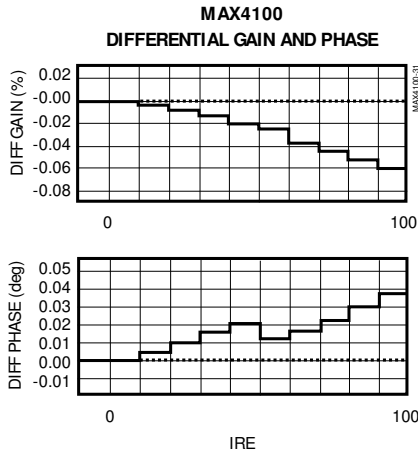
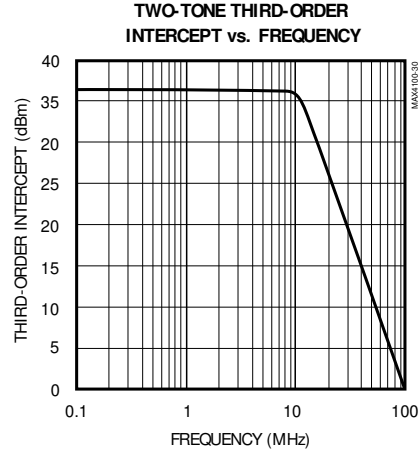
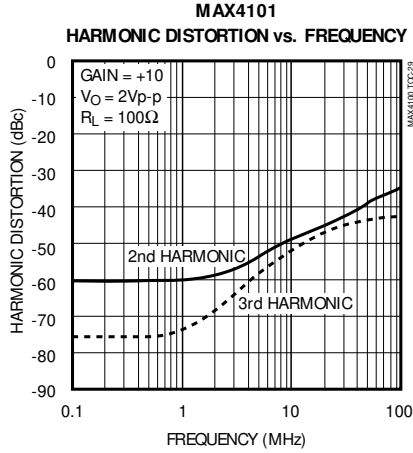

Pin Description

PIN	NAME	FUNCTION
1, 5, 8	N.C.	No Connection, not internally connected
2	IN-	Inverting Input
3	IN+	Noninverting Input
4	VEE	Negative Power Supply, connected to -5V
6	OUT	Amplifier Output
7	VCC	Positive Power Supply, connected to +5V

500MHz, Low-Power Op Amps

Detailed Description

The MAX4100/MAX4101 are low-power, high-bandwidth operational amplifiers optimized for driving back-terminated cables in composite video, RGB, and RF systems. The MAX4100 is unity-gain stable, and the MAX4101 is optimized for closed-loop gains greater than or equal to 2V/V ($A_{VCL} \geq 2V/V$). While consuming only 5mA (6mA max) supply current, both devices can drive 50Ω back-terminated cables to ±3.1V minimum.

The MAX4100 features a bandwidth in excess of 500MHz and a 0.1dB gain flatness of 65MHz. It offers differential gain and phase errors of 0.06%/0.04°, respectively. The MAX4101 features a -3dB bandwidth of 200MHz, a 0.1dB bandwidth of 50MHz, and 0.07%/0.04° differential gain and phase.

Available in small 8-pin SO and μMAX packages, these ICs are ideally suited for use in portable systems (in RGB, broadcast, or consumer video applications) that benefit from low power consumption.

Applications Information

Layout and Power-Supply Bypassing

The MAX4100/MAX4101 have an RF bandwidth and, consequently, require careful board layout. Depending on the size of the PC board used and the frequency of operation, it may be desirable to use constant-impedance microstrip or stripline techniques.

To realize the full AC performance of this high-speed amplifier, pay careful attention to power-supply bypassing and board layout. The PC board should have at least two layers: a signal and power layer on one side, and a large, low-impedance ground plane on the other side. The ground plane should be as free of voids as possible. With multilayer boards, locate the ground plane on a layer that incorporates no signal or power traces.

Regardless of whether a constant-impedance board is used, it is best to observe the following guidelines when designing the board. Wire-wrap boards are much too inductive, and breadboards are much too capacitive; neither should be used. IC sockets increase parasitic capacitance and inductance, and should not be used. In general, surface-mount components give better high-frequency performance than through-hole components. They have shorter leads and lower parasitic reactances. Keep lines as short and as straight as possible. Do not make 90° turns; round all corners.

High-frequency bypassing techniques must be observed to maintain the amplifier accuracy. The bypass capacitors should include a 1000pF ceramic capacitor between each supply pin and the ground plane, located as close to the package as possible. Next, place a 0.01μF to 0.1μF ceramic capacitor in parallel with each 1000pF capacitor, and as close to each as possible. Then place a 10μF to 15μF low-ESR tantalum at the point of entry (to the PC board) of the power-supply pins. The power-supply trace should lead directly from the tantalum capacitor to the VCC and VEE pins. To minimize parasitic inductance, keep PC traces short and use surface-mount components.

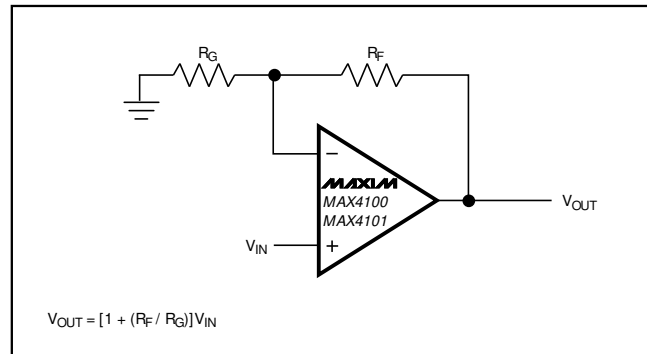

Figure 1b. Noninverting Gain Configuration

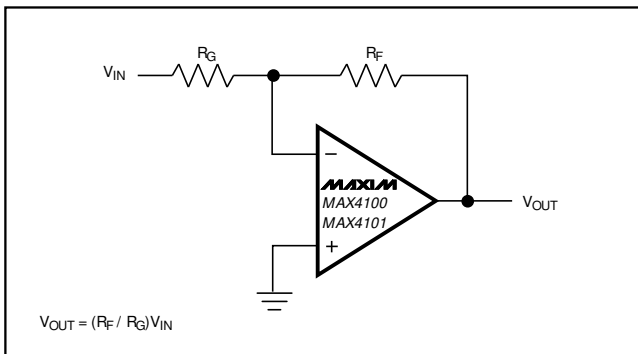

Figure 1a. Inverting Gain Configuration

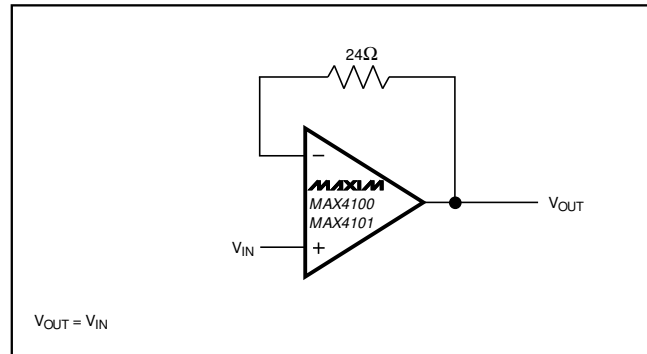

Figure 1c. MAX4100 Unity-Gain Buffer Configuration

500MHz, Low-Power Op Amps

MAX4100/MAX4101

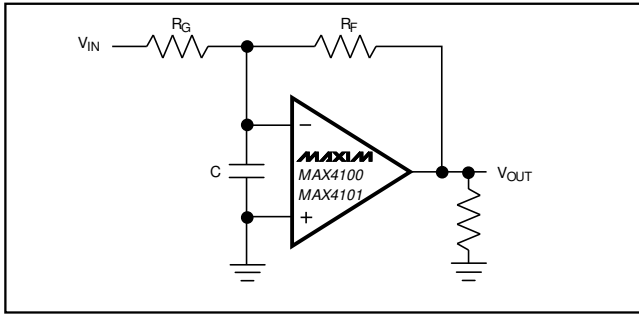

Figure 2. Effect of Feedback Resistor Values and Parasitic Capacitance on Bandwidth

Setting Gain

The MAX4100/MAX4101 are voltage-feedback op amps that can be configured as an inverting or noninverting gain block, as shown in Figures 1a and 1b. The gain is determined by the ratio of two resistors and does not affect amplifier frequency compensation.

In the unity-gain configuration (as shown in Figure 1c), maximum bandwidth and stability is achieved with the MAX4100 when a small feedback resistor is included. This resistor suppresses the negative effects of parasitic inductance and capacitance. A value of 24Ω provides the best combination of wide bandwidth, low peaking, and fast settling time. In addition, this resistor reduces the errors from input bias currents.

Choosing Resistor Values

The values of feedback and input resistors used in the inverting or noninverting gain configurations are not critical (as is the case with current feedback amplifiers). However, take care when selecting because the ohmic values need to be kept small and noninductive for practical reasons.

The input capacitance of the MAX4100/MAX4101 is approximately 2pF. In either the inverting or noninverting configuration, the bandwidth limit caused by the package capacitance and resistor time constant is $f_{3dB} = 1 / (2\pi RC)$, where R is the parallel combination of the input and feedback resistors (R_F and R_G in Figure 2) and C is the package and board capacitance at the inverting input. Table 1 shows the bandwidth limit for several values of R_F and R_G , assuming 4pF total capacitance (2pF for the MAX4100/MAX4101 and 2pF of PC board parasitics).

Table 1. Resistor and Bandwidth Values for Various Gain Configurations

GAIN (V/V)	R_G (Ω)	R_F (Ω)	BANDWIDTH LIMIT* (MHz)
+1	∞	24	1659
+2	200	200	398
+5	50	200	995
+10	30	270	1474
-1	200	200	398
-2	75	150	796
-5	50	250	955
-10	50	500	875

* Assuming an infinite bandwidth amplifier.

Resistor Types

Surface-mount resistors are the best choice for high-frequency circuits. They are of similar material to the metal film resistors, but are deposited using a thick-film process in a flat, linear manner so that inductance is minimized. Their small size and lack of leads also minimize parasitic inductance and capacitance, thereby yielding more predictable performance.

DC and Noise Errors

There are several major error sources to be considered in any operational amplifier. These apply equally to the MAX4100/MAX4101. Offset-error terms are given by the equation below. Voltage and current noise errors are root-square summed, so are computed separately. Using the circuit in Figure 3, the total output offset voltage is determined by:

- The input offset voltage (V_{OS}) times the closed-loop gain ($1 + R_F / R_G$)
- The positive input bias current (I_{B+}) times the source resistor (R_S) minus the negative input bias current (I_{B-}) times the parallel combination of R_G and R_F . I_{OS} (offset current) is the difference between the two bias currents. If $R_G \parallel R_F = R_S$, this part of the expression becomes $I_{OS} \times R_S$.

The equation for total DC error is:

$$V_{OUT} = (I_{OS}R_S + V_{OS}) \left(1 + \frac{R_F}{R_G} \right)$$

500MHz, Low-Power Op Amps

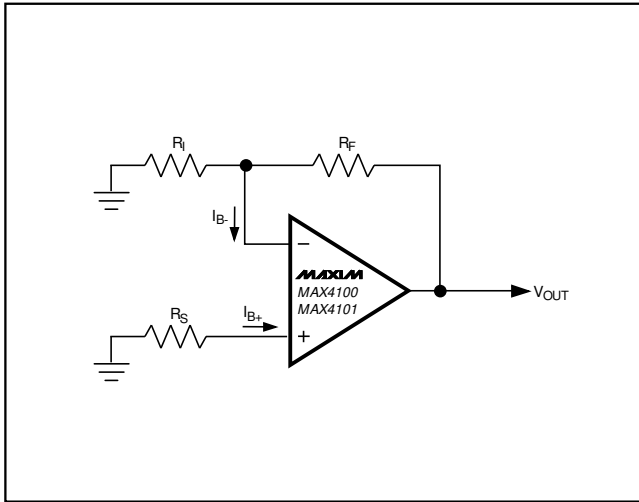

Figure 3. Output Offset Voltage

c) Total output-referred noise voltage is shown by the equation below ($e_{n(OUT)}$):

$$e_{n(OUT)} = \left(1 + \frac{R_F}{R_G}\right) \sqrt{(2i_n R_S)^2 + (e_n)^2}$$

The MAX4100/MAX4101, with two high-impedance inputs, have low $8\text{nV}/\sqrt{\text{Hz}}$ voltage noise and only $0.8\text{pA}/\sqrt{\text{Hz}}$ current noise.

An example of DC error calculations, using the MAX4100/MAX4101 typical data and the typical operating circuit with $R_F = R_G = 200\Omega$ ($R_S = 100\Omega$), gives:

$$V_{OUT} = (I_{OS}R_S + V_{OS}) \left(1 + \frac{R_F}{R_G}\right)$$

$$V_{OUT} = (3 \times 10^{-6} \times 10^2 + 1 \times 10^{-3}) (1+1)$$

$$V_{OUT} = 2.6\text{mV}$$

Calculating total output-referred noise in a similar manner yields:

$$e_{n(OUT)} = (1+1) \sqrt{(2 \times 0.8 \times 10^{-12} \times 100)^2 + (8 \times 10^{-9})^2}$$

$$e_{n(OUT)} = 8\text{nV}/\sqrt{\text{Hz}}$$

With a 200MHz system bandwidth, this calculates to $133\mu\text{V}_{RMS}$ (approximately $679\mu\text{V}_{p-p}$).

In both DC and noise calculations, errors are dominated by offset voltage and noise voltage (rather than by input bias current or noise current).

Metal-film resistors with leads are manufactured using a thin-film process, where resistive material is deposited in a spiral layer around a ceramic rod. Although the materials used are noninductive, the spiral winding presents a small inductance (about 5nH) that may have an adverse effect on high-frequency circuits.

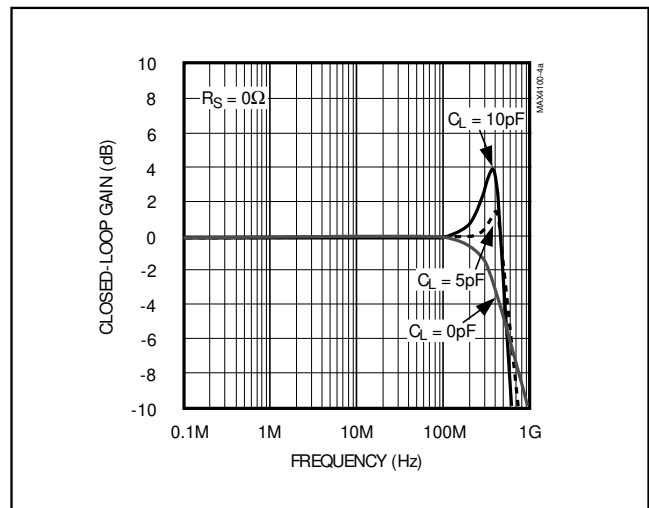

Figure 4a. MAX4100 Bandwidth vs. Capacitive Load

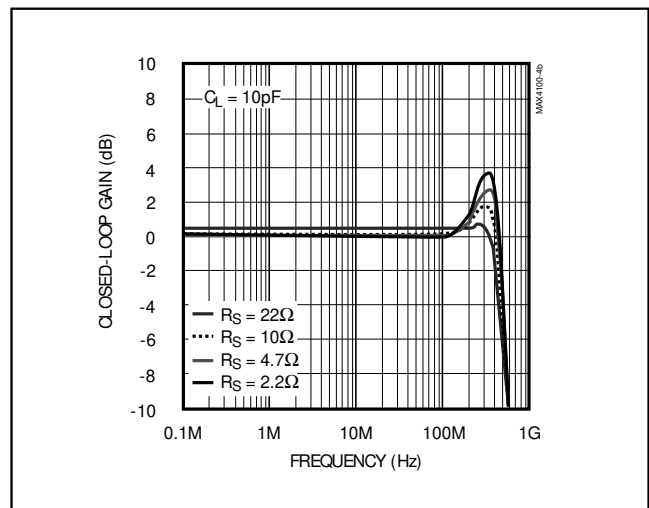

Figure 4b. MAX4100 Bandwidth vs. Capacitive Load and Isolation Resistor

500MHz, Low-Power Op Amps

MAX4100/MAX4101

Carbon composition resistors with leads are manufactured by pouring the resistor material into a mold. This process yields a relatively low-inductance resistor that is very useful in high-frequency applications, although they tend to cost more and have more thermal noise than other types. The ability of carbon composition resistors to self-heal after a large current overload makes them useful in high-power RF applications.

For general-purpose use, surface-mount metal-film resistors seem to have the best overall performance for low cost, low inductance, and low noise.

Driving Capacitive Loads

When driving 50Ω or 75Ω back-terminated transmission lines, capacitive loading is not an issue; therefore an isolation resistor is not required. For other applications where the ability to drive capacitive loads is required, the MAX4100/MAX4101 can typically drive 5pF and 20pF, respectively. Figure 4a illustrates how a capacitive load influences the amplifier's peaking without an isolation resistor (R_S). Figure 4b shows how an isolation resistor decreases the amplifier's peaking.

The MAX4100/MAX4101 can drive capacitive loads up to 5pF. By using a small isolation resistor between the amplifier output and the load, large capacitance values may be driven without oscillation (Figure 5a). In most cases, less than 50Ω is sufficient. Use Figure 5b to determine the value needed in your application. Determine the worst-case maximum capacitive load you may encounter and select the appropriate resistor from the graph.

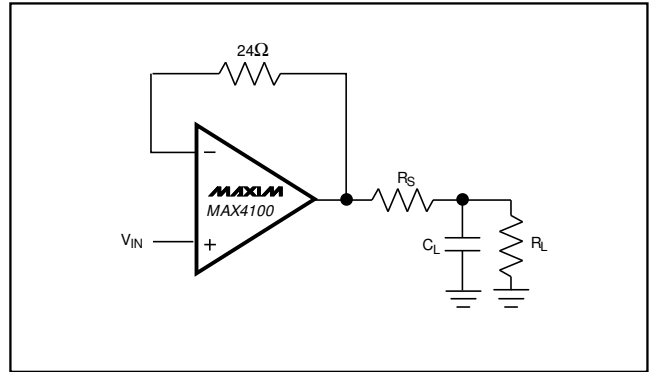

Figure 5a. Using an Isolation Resistor for High Capacitive Loads (MAX4100)

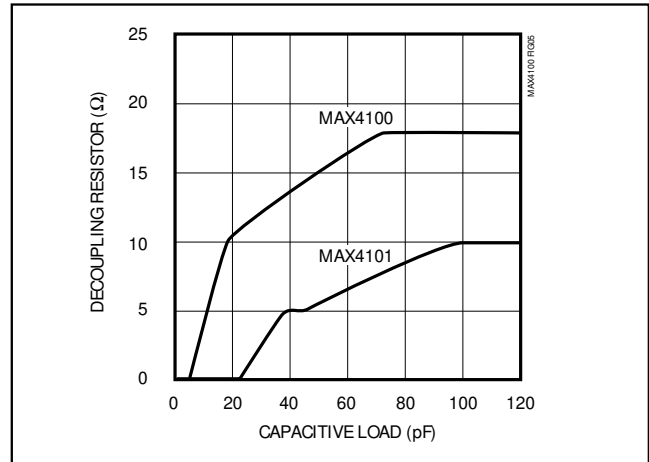
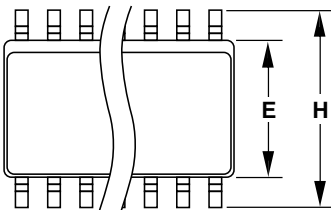
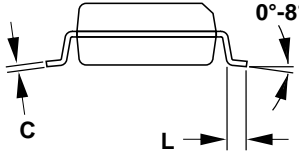
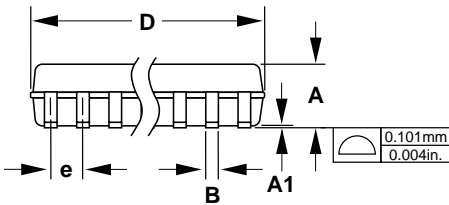

Figure 5b. Isolation vs. Capacitive Load

500MHz, Low-Power Op Amps

Package Information



**Narrow SO
SMALL-OUTLINE
PACKAGE
(0.150 in.)**

DIM	INCHES		MILLIMETERS	
	MIN	MAX	MIN	MAX
A	0.053	0.069	1.35	1.75
A1	0.004	0.010	0.10	0.25
B	0.014	0.019	0.35	0.49
C	0.007	0.010	0.19	0.25
E	0.150	0.157	3.80	4.00
e	0.050		1.27	
H	0.228	0.244	5.80	6.20
L	0.016	0.050	0.40	1.27

DIM	PINS	INCHES		MILLIMETERS	
		MIN	MAX	MIN	MAX
D	8	0.189	0.197	4.80	5.00
D	14	0.337	0.344	8.55	8.75
D	16	0.386	0.394	9.80	10.00

21-0041A

Maxim cannot assume responsibility for use of any circuitry other than circuitry entirely embodied in a Maxim product. No circuit patent licenses are implied. Maxim reserves the right to change the circuitry and specifications without notice at any time.

12 _____ Maxim Integrated Products, 120 San Gabriel Drive, Sunnyvale, CA 94086 (408) 737-7600