

TPS56C215 SWIFT™ Buck Converter Evaluation Module User's Guide



ABSTRACT

This user's guide contains information for the TPS56C215EVM-762 evaluation module (PWR762) as well as for the TPS56C215 dc/dc converter. Also included are the performance specifications, the schematic, and the bill of materials for the TPS56C215EVM-762.

Table of Contents

1 Introduction	2
2 Test Setup and Results	3
3 Board Layout	13
4 Schematic and Bill of Materials	16
5 Revision History	18

List of Figures

Figure 2-1. TPS56C215EVM-762 Efficiency.....	4
Figure 2-2. TPS56C215EVM-762 Low Current Efficiency.....	4
Figure 2-3. TPS56C215EVM-762 Load Regulation, $V_{IN} = 5\text{ V}$	5
Figure 2-4. TPS56C215EVM-762 Load Regulation, $V_{IN} = 12\text{ V}$	5
Figure 2-5. TPS56C215EVM-762 Line Regulation.....	6
Figure 2-6. TPS56C215EVM-762 Transient Response.....	6
Figure 2-7. TPS56C215EVM-762 Loop Response.....	7
Figure 2-8. TPS56C215EVM-762 Output Ripple, 10 mA Load.....	7
Figure 2-9. TPS56C215EVM-762 Output Ripple, 800 mA Load.....	8
Figure 2-10. TPS56C215EVM-762 Output Ripple, 12-A Load.....	8
Figure 2-11. TPS56C215EVM-762 Input Ripple, 10-mA Load.....	9
Figure 2-12. TPS56C215EVM-762 Input Ripple, 800-mA Load.....	9
Figure 2-13. TPS56C215EVM-762 Input Ripple, 12-A Load.....	10
Figure 2-14. TPS56C215EVM-762 Start-Up Relative to V_{IN}	11
Figure 2-15. TPS56C215EVM-762 Start-Up Relative to Enable.....	11
Figure 2-16. Shutdown Relative to V_{IN}	12
Figure 2-17. Shutdown Relative to Enable.....	12
Figure 3-1. TPS56C215EVM-762 Top-Side Assembly.....	13
Figure 3-2. TPS56C215EVM-762 Top-Side Layout.....	14
Figure 3-3. TPS56C215EVM-762 Internal Layer-1 Layout.....	14
Figure 3-4. TPS56C215EVM-762 Internal Layer-2 Layout.....	15
Figure 3-5. TPS56C215EVM-762 Bottom-Side Layout.....	15
Figure 4-1. TPS56C215EVM-762 Schematic.....	16

List of Tables

Table 1-1. Input Voltage and Output Current Summary.....	2
Table 1-2. TPS56C215EVM-762 Performance Specification Summary.....	2
Table 2-1. EVM Connectors and Test Points.....	3
Table 4-1. TPS56C215EVM-762 Bill of Materials.....	17

Trademarks

All trademarks are the property of their respective owners.

1 Introduction

1.1 Background

The TPS56C215 dc/dc converter is a synchronous buck converter designed to provide up to a 14-A output. The input (V_{IN}) is rated for 4.5 V to 17 V. The TPS56C215 uses a proprietary DCAP3 Control mode and a MODE pin is used to select output current limit, switching frequency, and Forced Continuous Conduction Mode (FCCM)/Discontinuous Conduction Mode (DCM) operation. Rated input voltage and output current range for the evaluation module are given in [Table 1-1](#). This evaluation module is designed to demonstrate the small printed-circuit-board areas that may be achieved when designing with the TPS56C215 regulator. The MODE pin is configured for 1.2-MHz switching frequency, 12-A and DCM operation. The high-side and low-side MOSFETs are incorporated inside the TPS56C215 package along with the gate drive circuitry. The low drain-to-source on-resistance of the MOSFET allows the TPS56C215 to achieve high efficiencies and helps keep the junction temperature low at high output currents. An external divider allows for an adjustable output voltage. Additionally, the TPS56C215 provides adjustable slow start and undervoltage lockout inputs and a power good output.

Table 1-1. Input Voltage and Output Current Summary

EVM	Input Voltage Range	Output Current Range
TPS56C215EVM-762	$V_{IN} = 4.5 \text{ V to } 17 \text{ V}$	0 A to 12 A

1.2 Performance Specification Summary

A summary of the TPS56C215EVM-762 performance specifications is provided in [Table 1-2](#). Specifications are given for an input voltage of $V_{IN} = 12 \text{ V}$ and an output voltage of 1.2 V, unless otherwise specified. The TPS56C215EVM-762 is designed and tested for $V_{IN} = 4.5 \text{ V to } 17 \text{ V}$. The ambient temperature is 25°C for all measurements, unless otherwise noted.

Table 1-2. TPS56C215EVM-762 Performance Specification Summary

Specification	Test Conditions	MIN	TYP	MAX	Unit	
V_{IN} voltage range		4.5	12	17	V	
V_{IN} start voltage			Internal UVLO		V	
V_{IN} stop voltage			Internal UVLO		V	
Output voltage setpoint			1.2		V	
Output current range	$V_{IN} = 9.2 \text{ V to } 14 \text{ V}$	0		12	A	
Line regulation	$I_O = 6 \text{ A}, V_{IN} = 4.5 \text{ V to } 17 \text{ V}$		$\pm 0.05\%$			
Load regulation	$V_{IN} = 12 \text{ V}, I_O = 0 \text{ A to } 12 \text{ A}$		-0.02%, +0.6%			
Load transient response	$I_O = 3 \text{ A to } 9 \text{ A}$	Voltage change	-30		mV	
		Recovery time		50	μs	
	$I_O = 9 \text{ A to } 3 \text{ A}$	Voltage change		30		mV
		Recovery time		50		μs
Loop bandwidth	$V_{IN} = 12 \text{ V}, I_O = 6 \text{ A}$		135		kHz	
Phase margin	$V_{IN} = 12 \text{ V}, I_O = 6 \text{ A}$		72		degree	
Input ripple voltage	$I_O = 12 \text{ A}$		120		mVPP	
Output ripple voltage	$I_O = 12 \text{ A}$		10		mVPP	
Output rise time			6		ms	
Operating frequency			1.2		MHz	
Maximum efficiency	TPS56C215EVM-762, $V_{IN} = 5 \text{ V}, I_O = 5.7 \text{ A}$		82.2%			

1.3 Modifications

These evaluation modules are designed to provide access to the features of the TPS56C215. Some modifications can be made to this module.

1.3.1 Output Voltage Setpoint

The output voltage is set by the resistor divider network of R7 ($R_{(TOP)}$) and R9 ($R_{(BOT)}$). R9 is fixed at 10.0 k Ω . To change the output voltage of the EVM, it is necessary to change the value of resistor R7. Changing the value of R9 can change the output voltage above the 0.6 V reference voltage V_{REF} . The value of R7 for a specific output voltage can be calculated using [Equation 1](#).

$$R_{(TOP)} = \frac{R_{(BOT)} \times (V_{OUT} - V_{REF})}{V_{REF}} \quad (1)$$

1.3.2 Adjustable UVLO

The undervoltage lockout (UVLO) can be adjusted externally using R1 ($R_{EN(TOP)}$) and R2 ($R_{EN(BOT)}$). R1 and R2 are not populated on the EVM, which uses the internal UVLO default settings. See the TPS56C215 datasheet (SLVSD05) for detailed instructions for setting the external UVLO.

2 Test Setup and Results

This section describes how to properly connect, set up, and use the TPS56C215EVM-762 evaluation module. The section also includes test results typical for the evaluation module and covers efficiency, output voltage regulation, load transients, loop response, output ripple, input ripple, and start-up.

2.1 Input/Output Connections

The TPS56C215EVM-762 is provided with input/output connectors and test points as shown in [Table 2-1](#). A power supply capable of supplying greater than 4 A must be connected to J1 through a pair of 20-AWG wires or better. The load must be connected to J2 through a pair of 20-AWG wires or better. The maximum load current capability is 12 A. Wire lengths must be minimized to reduce losses in the wires. Test-point TP1 provides a place to monitor the V_{IN} input voltages with TP2 providing a convenient ground reference. TP9 is used to monitor the output voltage with TP10 as the ground reference.

Table 2-1. EVM Connectors and Test Points

Reference Designator	Function
J1	VIN input voltage connector. (See Table 1-1 for V_{IN} range)
J2	1.2 V at 10 A maximum
J3	2-pin header for enable. Connect EN to ground to disable, open to enable. V_{OUT} .
J4	VOUT, 1.2 V at 10 A maximum
TP1	VIN test point
TP2	GND test point at VIN connector
TP3	Slow Start (SS) test point
TP4	PGOOD test point
TP5	VREG5 test point
TP6	Test point between voltage divider network and output. Used for loop response measurements
TP7	SW node test point
TP8	AGND test point
TP9	VOUT test point
TP10	GND test point

2.2 Efficiency

The efficiency of this EVM peaks at a load current of about 5 A and then decreases as the load current increases toward full load. [Figure 2-1](#) shows the efficiency for the TPS56C215EVM-762 at an ambient temperature of 25°C.

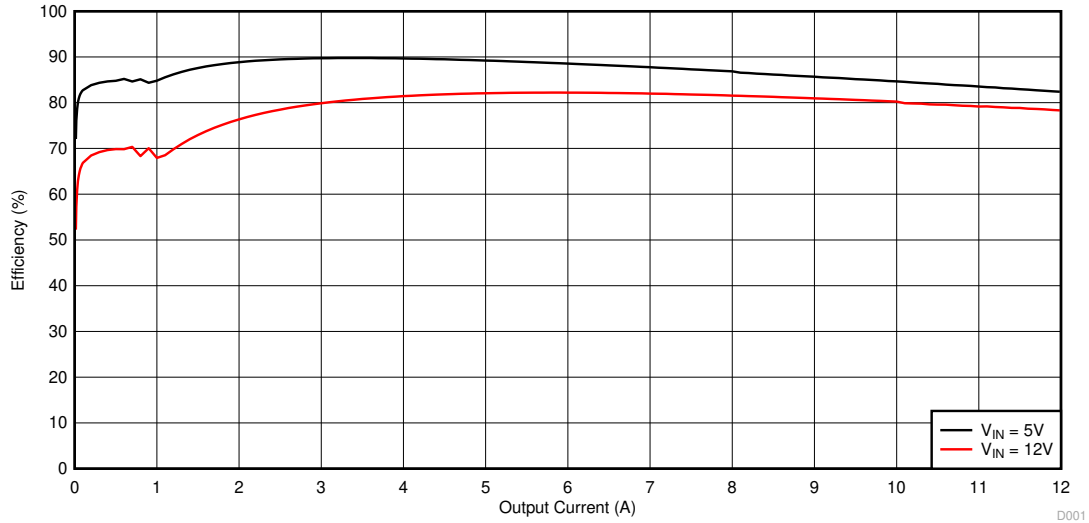

Figure 2-1. TPS56C215EVM-762 Efficiency

[Figure 2-2](#) shows the efficiency for the TPS56C215EVM-762 using a semi-log scale to more easily show efficiency at lower output currents. The ambient temperature is 25°C.

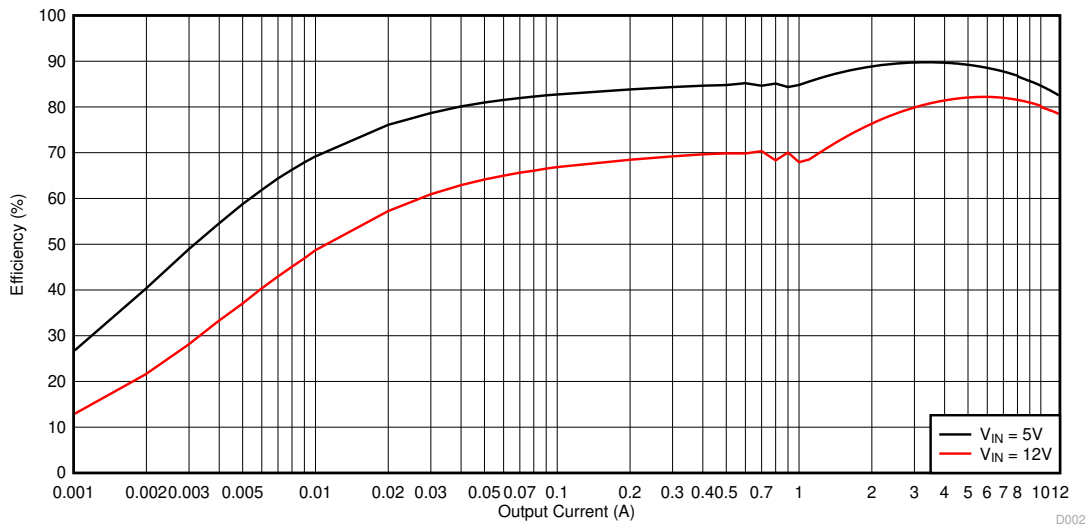

Figure 2-2. TPS56C215EVM-762 Low Current Efficiency

The efficiency may be lower at higher ambient temperatures, due to temperature variation in the drain-to-source resistance of the internal MOSFET.

2.3 Output Voltage Load Regulation

Figure 2-3 and Figure 2-4 show the load regulation for the TPS56C215EVM-762.

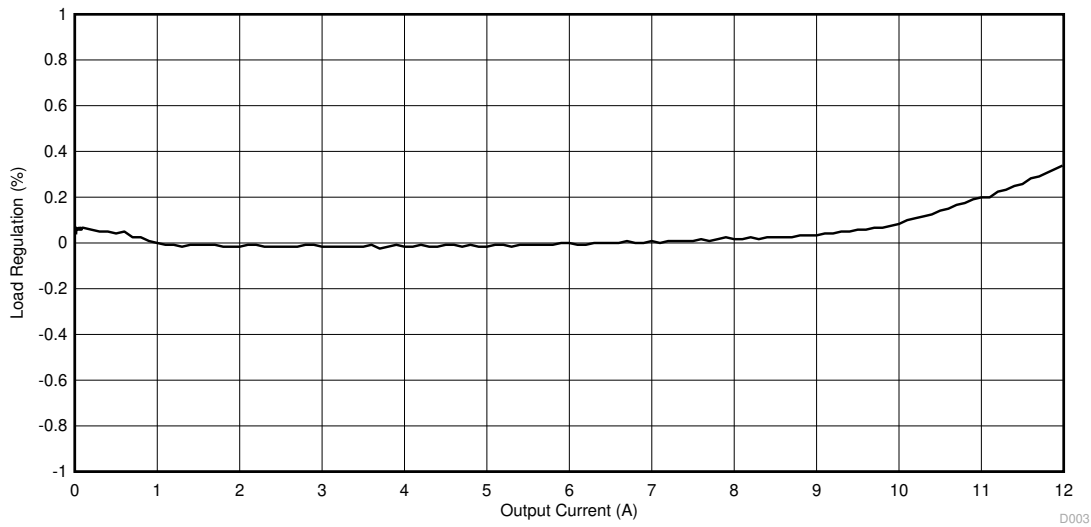

Figure 2-3. TPS56C215EVM-762 Load Regulation, $V_{IN} = 5\text{ V}$

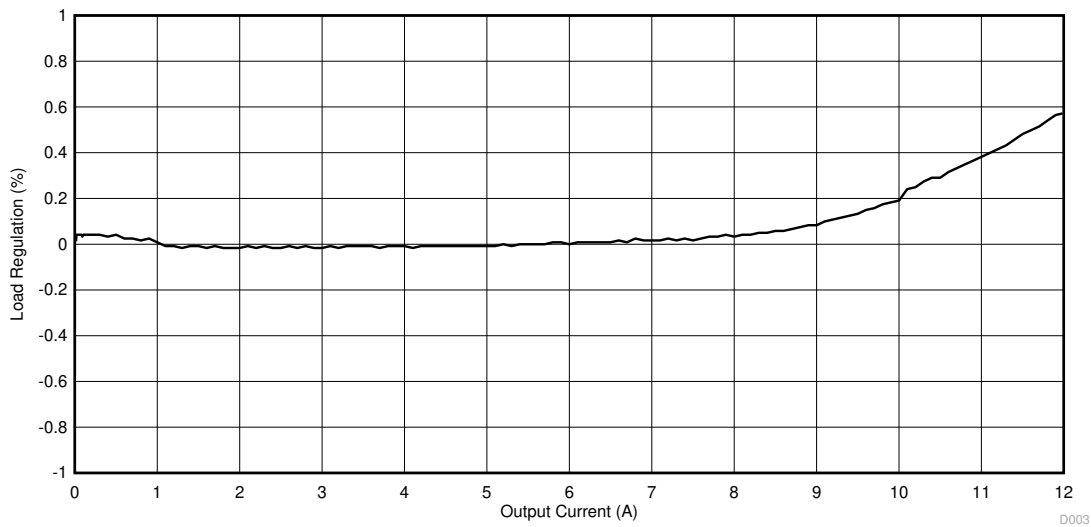

Figure 2-4. TPS56C215EVM-762 Load Regulation, $V_{IN} = 12\text{ V}$

Measurements are given for an ambient temperature of 25°C.

2.4 Output Voltage Line Regulation

Figure 2-5 shows the line regulation for the TPS56C215EVM-762.

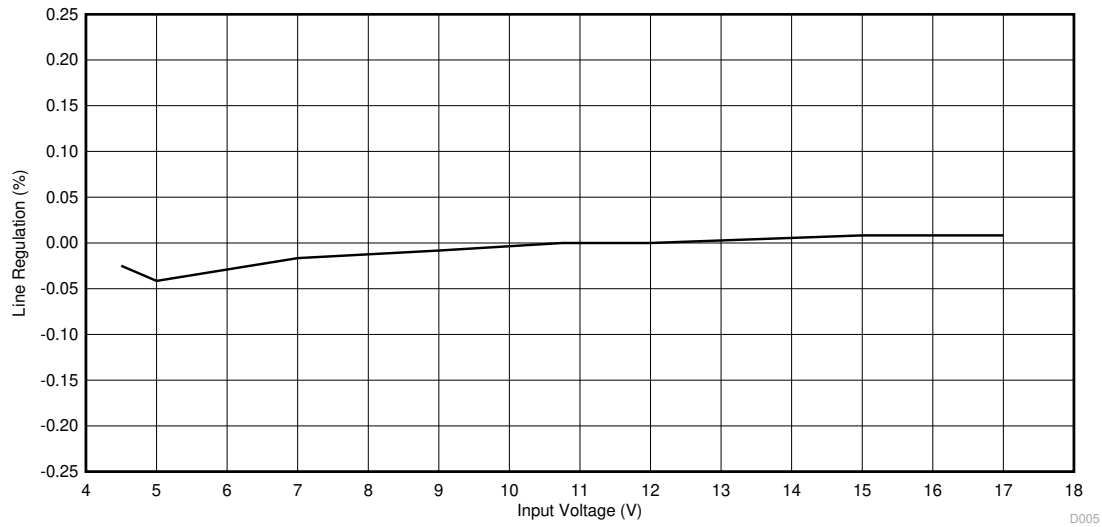

Figure 2-5. TPS56C215EVM-762 Line Regulation

2.5 Load Transients

Figure 2-6 shows the TPS56C215EVM-762 response to load transients. The current step is from 3 A to 9 A. The current step slew rate is 1 A/μs. Total peak-to-peak voltage variation is as shown, including ripple and noise on the output. The transient waveform is measured using the on-board fast transient circuit.

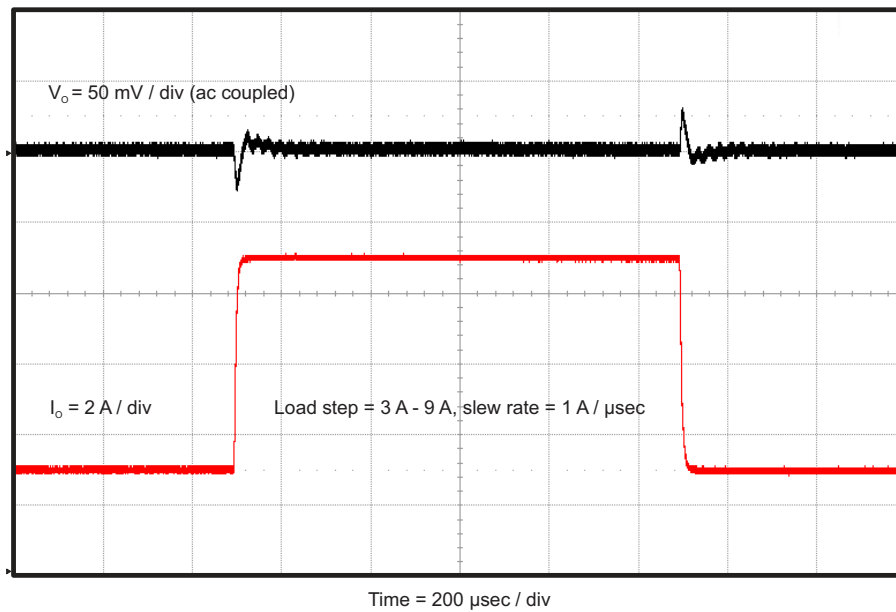

Figure 2-6. TPS56C215EVM-762 Transient Response

2.6 Loop Characteristics

Figure 2-7 shows the TPS56C215EVM-762 loop-response characteristics. Gain and phase plots are shown for V_{IN} voltage of 12 V. Load current for the measurement is 5 A.

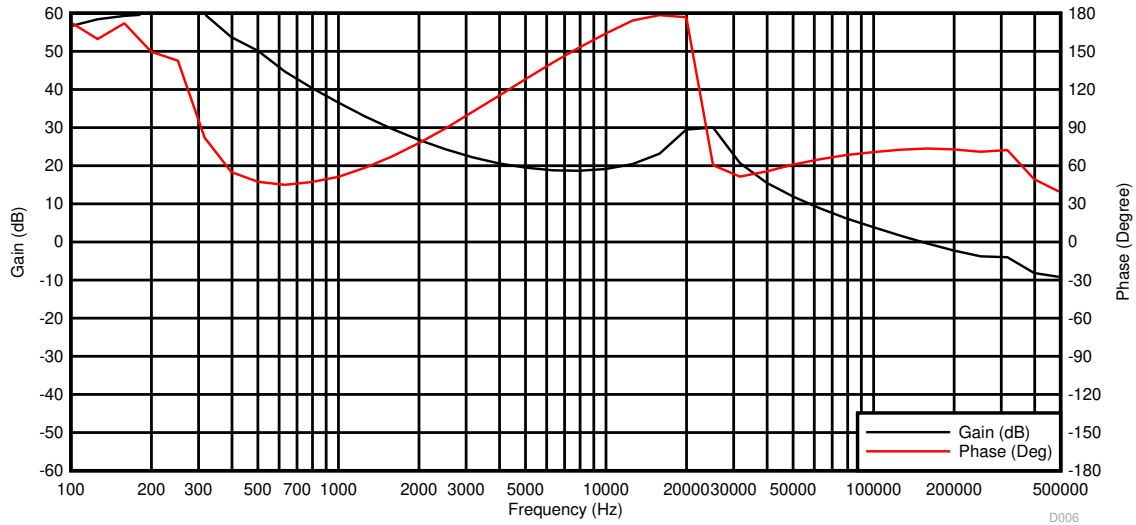

Figure 2-7. TPS56C215EVM-762 Loop Response

2.7 Output Voltage Ripple

Figure 2-8, Figure 2-9, and Figure 2-10 show the TPS56C215EVM-762 output voltage ripple. The load currents are 10 mA, 800 mA and 12 A. V_{IN} = 12 V. The ripple voltage is measured directly across TP7 and TP8.

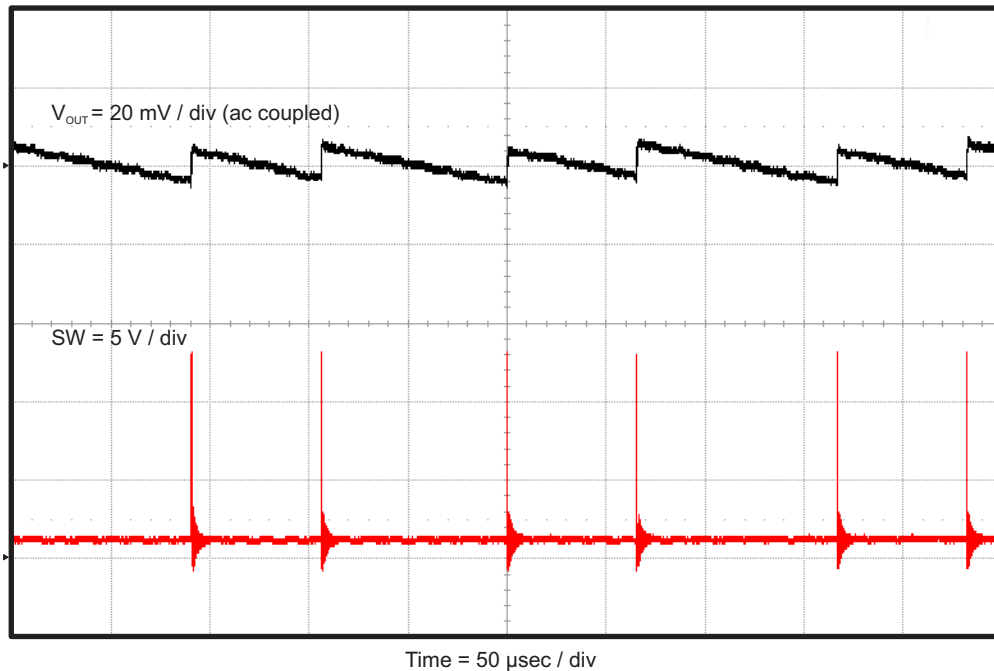

Figure 2-8. TPS56C215EVM-762 Output Ripple, 10 mA Load

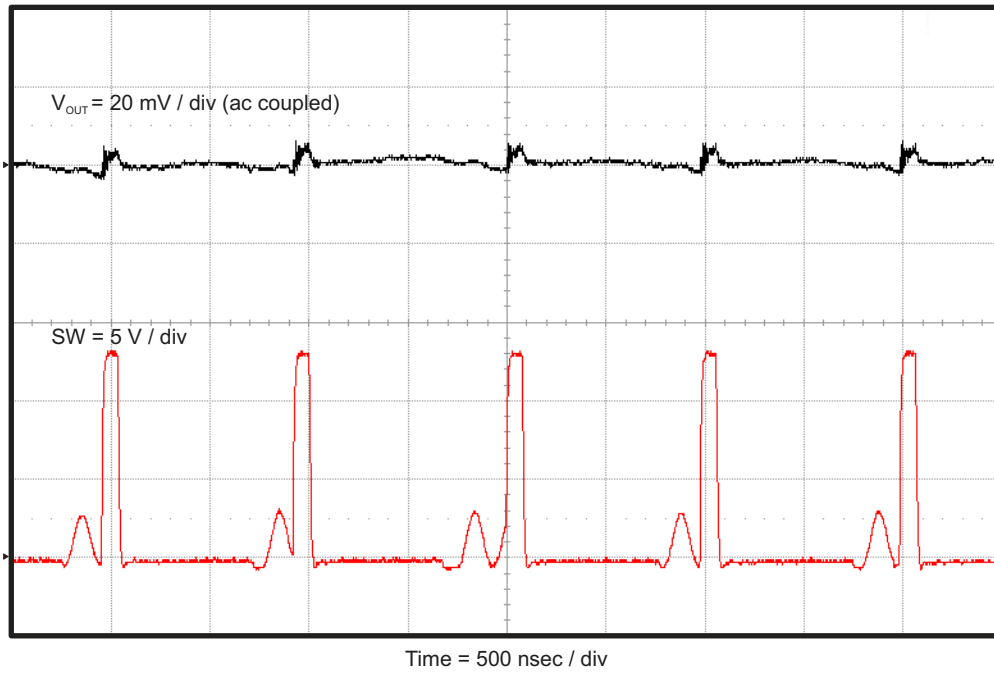

Figure 2-9. TPS56C215EVM-762 Output Ripple, 800 mA Load

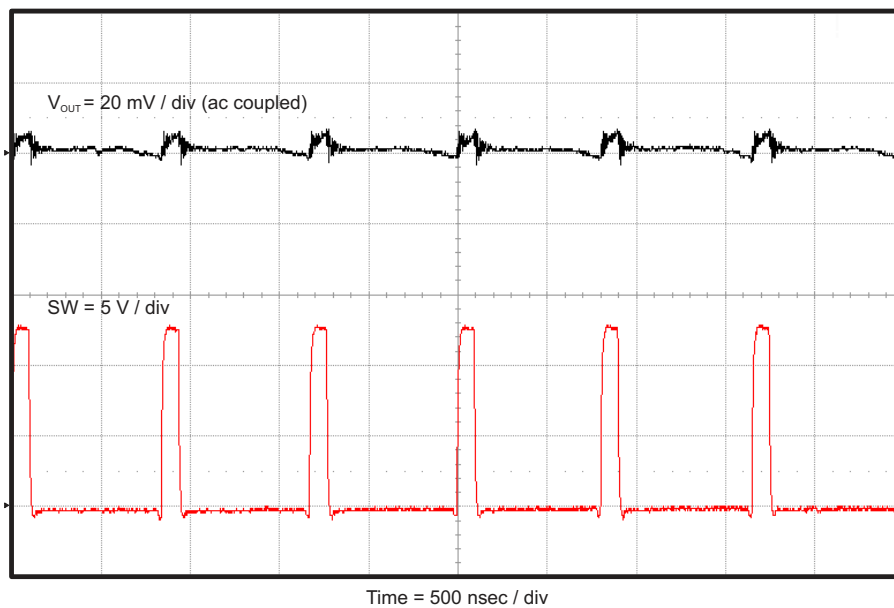

Figure 2-10. TPS56C215EVM-762 Output Ripple, 12-A Load

2.8 Input Voltage Ripple

Figure 2-11, Figure 2-12, and Figure 2-13 show the TPS56C215EVM-762 input voltage ripple. The load currents are 10 mA, 800 mA and 12 A. $V_{IN} = 12$ V. The ripple voltage is measured directly across TP1 and TP2.

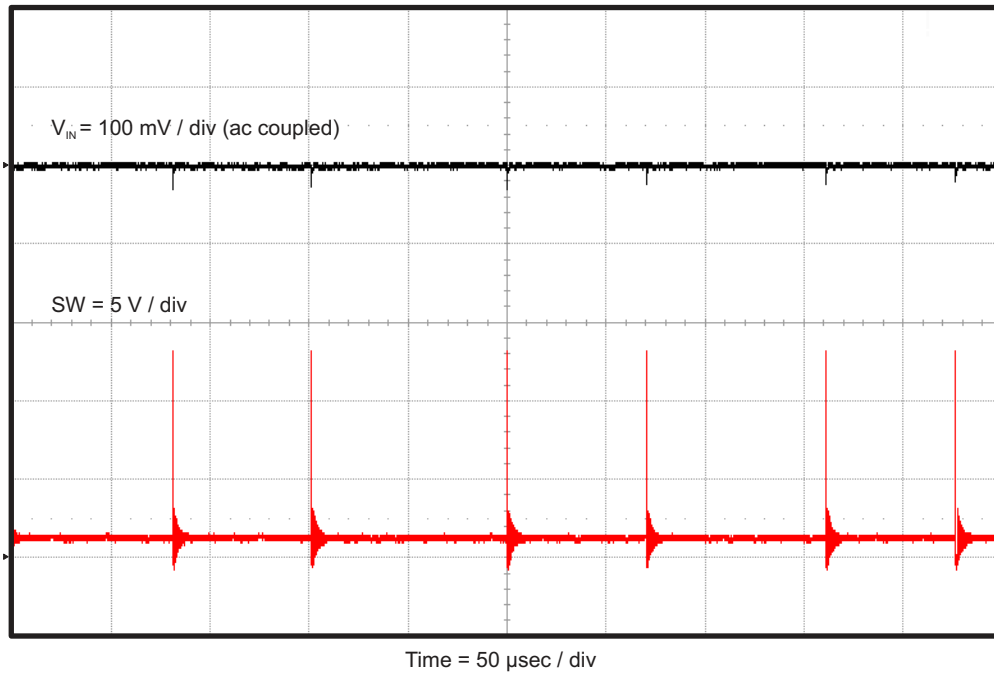

Figure 2-11. TPS56C215EVM-762 Input Ripple, 10-mA Load

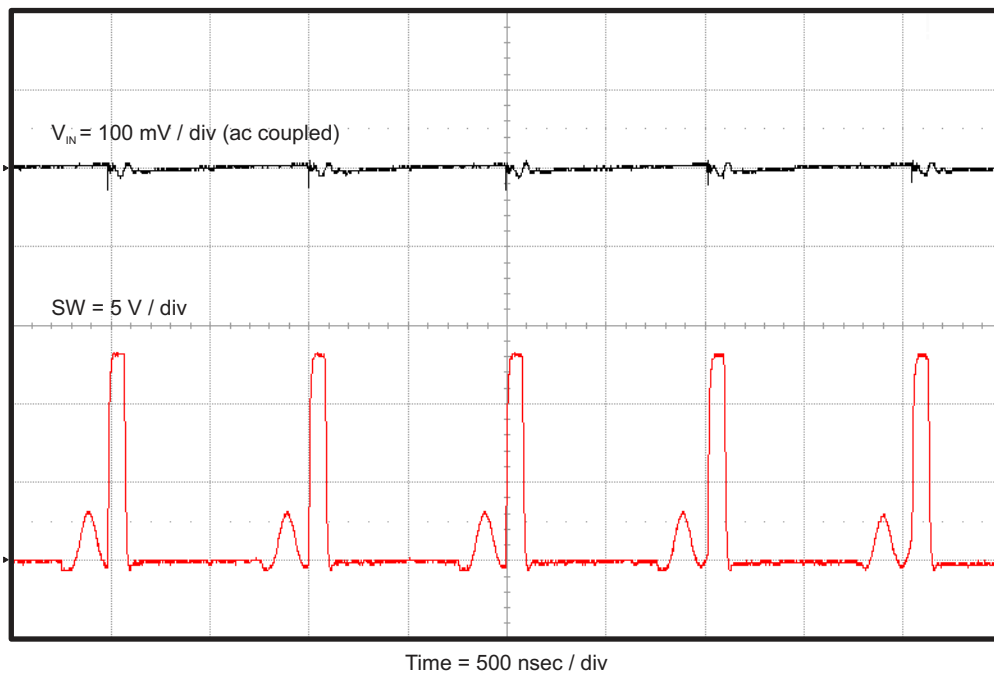

Figure 2-12. TPS56C215EVM-762 Input Ripple, 800-mA Load

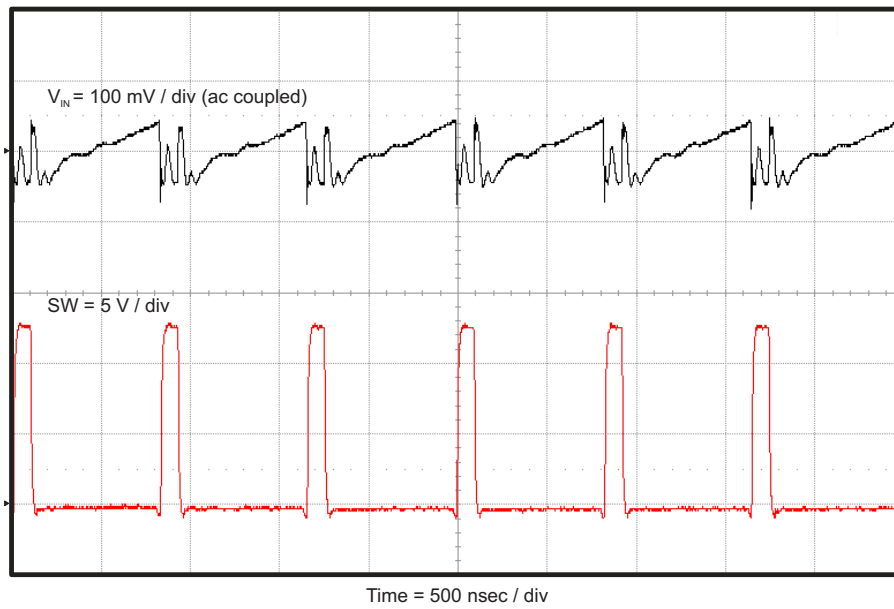

Figure 2-13. TPS56C215EVM-762 Input Ripple, 12-A Load

2.9 Powering Up

Figure 2-14 and Figure 2-15 show the start-up waveforms for the TPS56C215EVM-762. In Figure 2-14, the output voltage ramps up as soon as the input voltage reaches the UVLO threshold. In Figure 2-15, the input voltage is initially applied and the output is inhibited by using a jumper at J2 to tie EN to GND. When the jumper is removed, EN is released. When the EN voltage reaches the enable-threshold voltage, the start-up sequence begins and the output voltage ramps up to the externally set value of 1.2 V. The input voltage for these plots is 12 V and the load is 1 Ω .

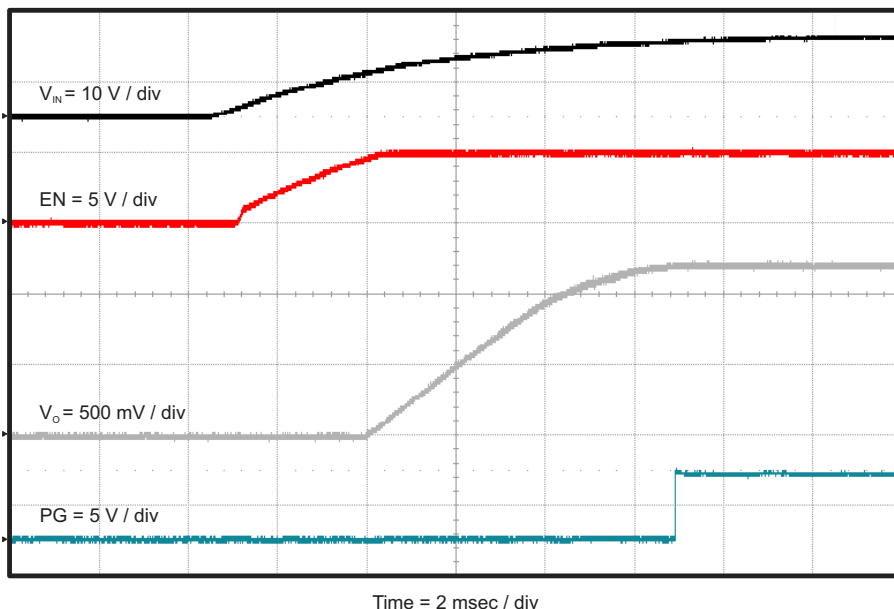

Figure 2-14. TPS56C215EVM-762 Start-Up Relative to V_{IN}

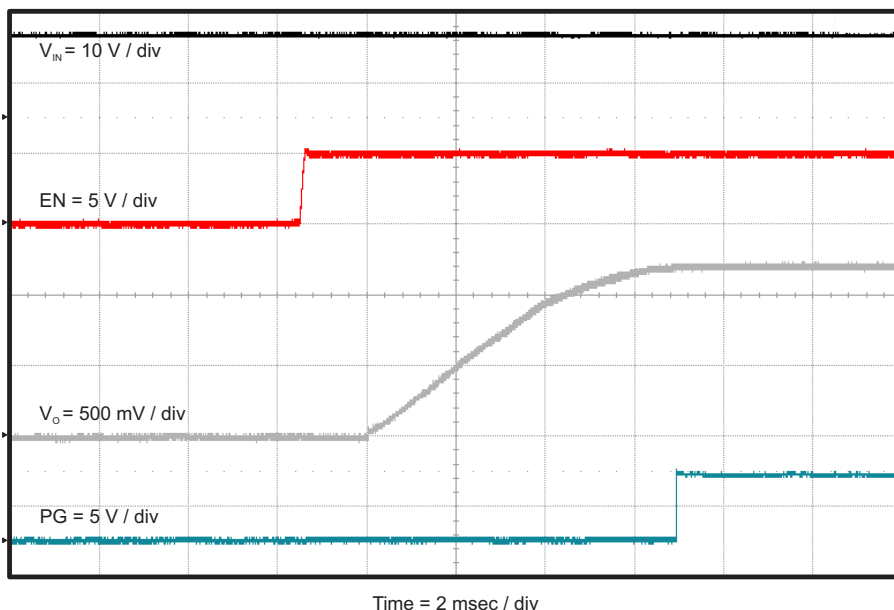

Figure 2-15. TPS56C215EVM-762 Start-Up Relative to Enable

2.10 Powering Down

Figure 2-16 and Figure 2-17 show the shutdown waveforms for the TPS56C215EVM-762. The input voltage for these plots is 12 V and the load is 1 Ω .

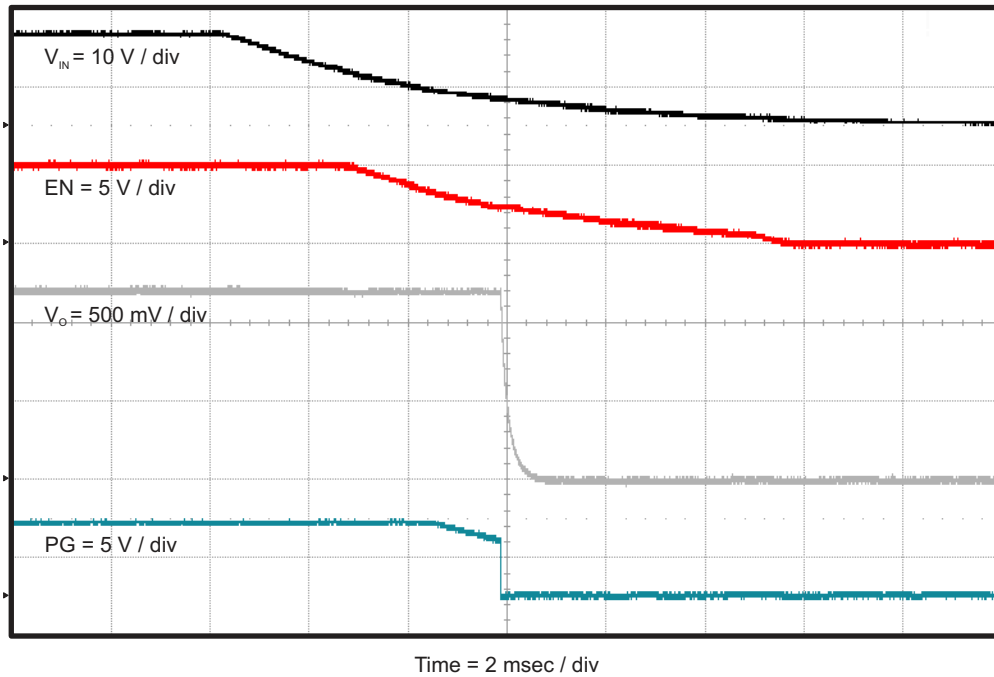

Figure 2-16. Shutdown Relative to V_{IN}

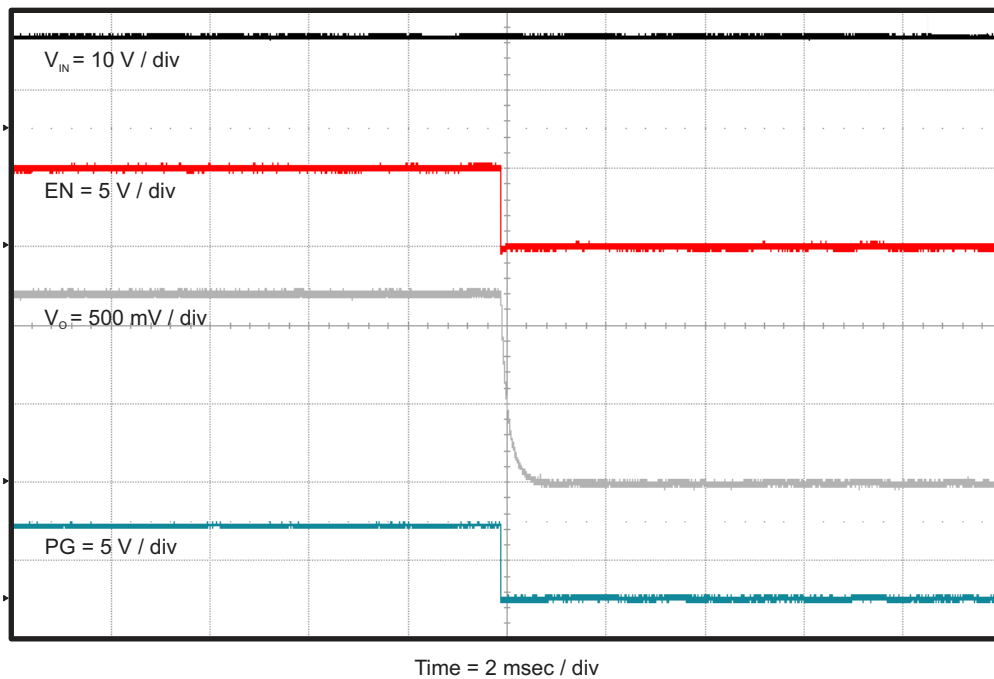

Figure 2-17. Shutdown Relative to Enable

3 Board Layout

This section provides a description of the TPS56C215EVM-762 board layout and layer illustrations.

3.1 Layout

The board layout for the TPS56C215EVM-762 is shown in [Figure 3-1](#) through [Figure 3-5](#). The top-side layer of the EVM is laid out in a manner typical of a user application. The top, bottom, and internal layers are 2-oz. copper.

The top layer contains the main power traces for VIN, VOUT, and SW. Also on the top layer are connections for the remaining pins of the TPS56C215 and the majority of the signal traces. There is a large area filled with ground. The internal layer-1 is dedicated ground plane with an island for quiet analog ground that is connected to the main power ground plane at a single point. The internal layer-2 contains an additional large ground copper area as well as an additional VIN and VOUT copper fill. The bottom layer is another ground plane with two additional traces for the output voltage feedback and BST capacitor connection. The top-side ground traces are connected to the bottom and internal ground planes with multiple vias placed around the board.

The input decoupling capacitors and bootstrap capacitor are all located as close to the IC as possible. Additionally, the voltage setpoint resistor divider components are kept close to the IC. The voltage divider network ties to the output voltage at the point of regulation, the copper V_{OUT} trace at the TP9 test point. For the TPS56C215, an additional input bulk capacitor may be required, depending on the EVM connection to the input supply. Critical analog circuits such as the voltage set point divider, EN resistor, SS capacitor, MODE resistor, and AGND pin are terminated to quiet analog ground island on the internal layer-1.

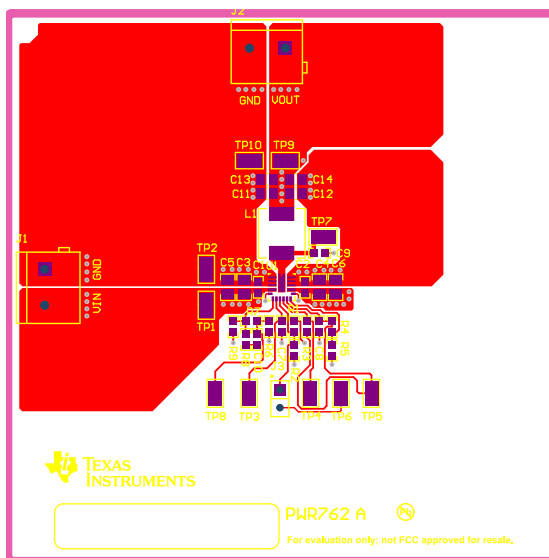

Figure 3-1. TPS56C215EVM-762 Top-Side Assembly

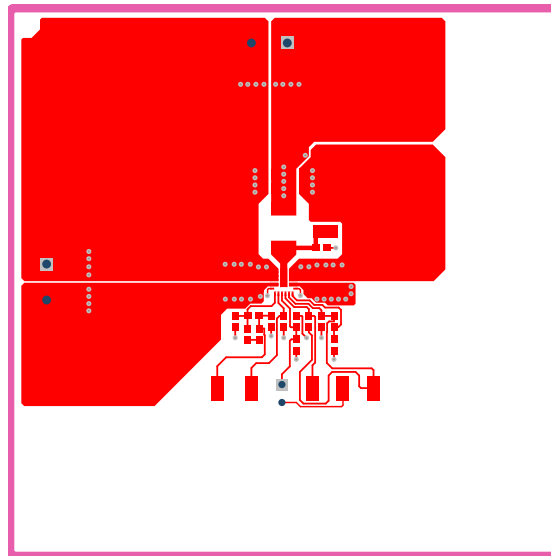

Figure 3-2. TPS56C215EVM-762 Top-Side Layout

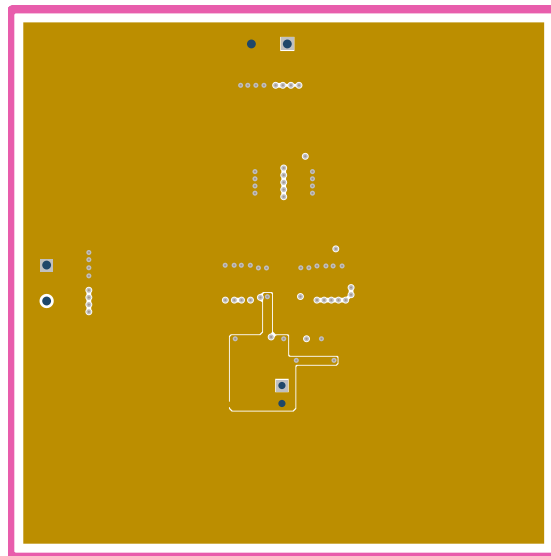

Figure 3-3. TPS56C215EVM-762 Internal Layer-1 Layout

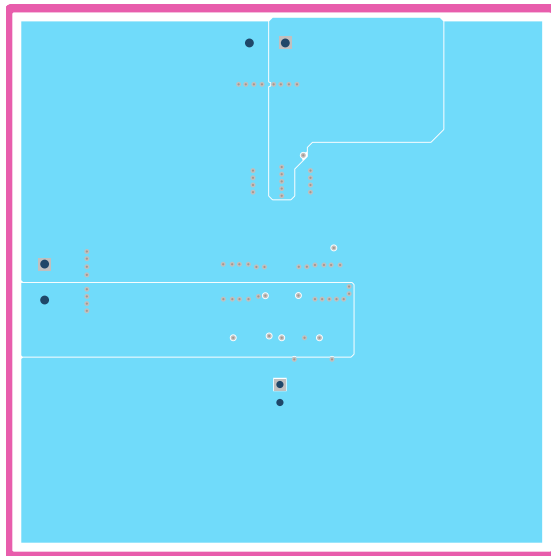

Figure 3-4. TPS56C215EVM-762 Internal Layer-2 Layout

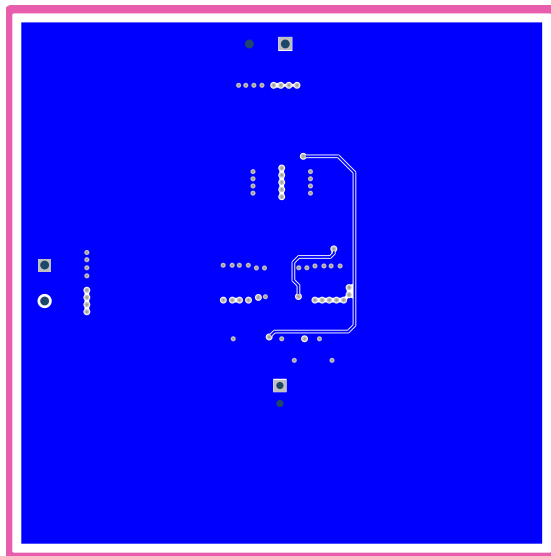

Figure 3-5. TPS56C215EVM-762 Bottom-Side Layout

4 Schematic and Bill of Materials

This section presents the TPS56C215EVM-762 schematic and bill of materials.

4.1 Schematic

Figure 4-1 is the schematic for the TPS56C215EVM-762.

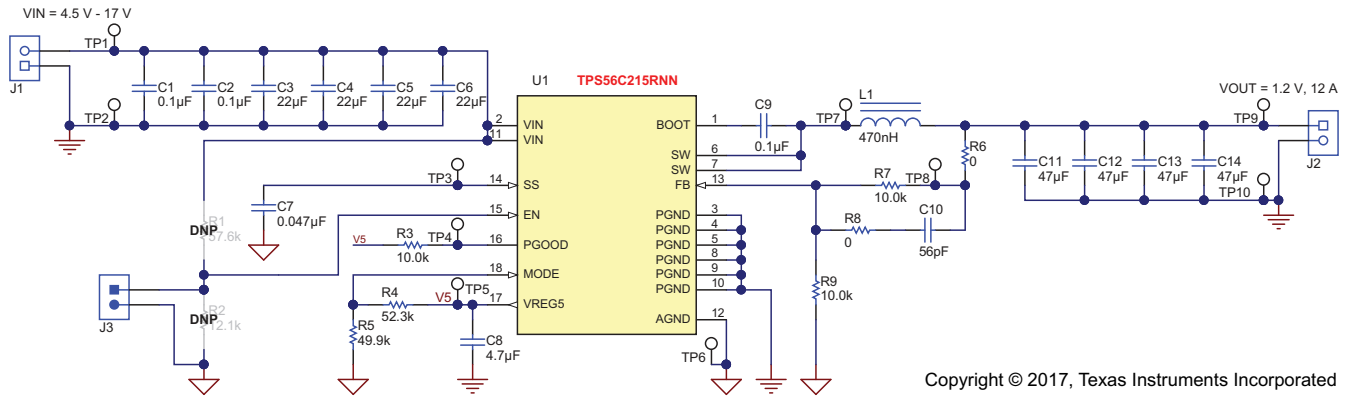

Figure 4-1. TPS56C215EVM-762 Schematic

4.2 Bill of Materials

Table 4-1 presents the bill of materials for the TPS56C215EVM-762.

Table 4-1. TPS56C215EVM-762 Bill of Materials

Designator	Qty	Value	Description	Package Reference	Part Number	Manufacturer
!PCB1	1		Printed Circuit Board		PWR762	Any
C1, C2, C9	3	0.1uF	CAP, CERM, 0.1 μ F, 25 V, +/- 10%, X7R, 0603	0603	GRM188R71E104KA01D	Murata
C3, C4, C5, C6	4	22uF	CAP, CERM, 22 μ F, 35 V, +/- 20%, X5R, 0805	0805	C2012X5R1V226M125AC	TDK
C7	1	0.047uF	CAP, CERM, 0.047 μ F, 50 V, +/- 10%, X7R, 0603	0603	GRM188R71H473KA61D	Murata
C8	1	4.7uF	CAP, CERM, 4.7 μ F, 10 V, +/- 20%, X5R, 0603	0603	GRM188R61A475ME15	Murata
C10	1	56pF	CAP, CERM, 56 pF, 50 V, +/- 5%, C0G/NP0, 0603	0603	GRM1885C1H560JA01D	Murata
C11, C12, C13, C14	4	47uF	CAP, CERM, 47 μ F, 10 V, +/- 20%, X5R, 0805	0805	GRM21BR61A476ME15	Murata
J1, J2	2		TERMINAL BLOCK 5.08MM VERT 2POS, TH		ED120/2DS	On-Shore Technology
J3	1		Header, 100mil, 2x1, Gold, TH		HTSW-102-07-G-S	Samtec
L1	1	470nH	Inductor, Shielded Drum Core, Powdered Iron, 470 nH, 17.5 A, 0.004 ohm, SMD	IHLP-2525CZ	IHLP2525CZERR47M01	Vishay-Dale
LBL1	1		Thermal Transfer Printable Labels, 1.250" W x 0.250" H - 10,000 per roll	PCB Label 1.25"H x 0.250"W	THT-13-457-10	Brady
R3, R7, R9	3	10.0k	RES, 10.0 k, 1%, 0.1 W, 0603	0603	CRCW060310K0FKEA	Vishay-Dale
R4	1	52.3k	RES, 52.3 k, 1%, 0.1 W, 0603	0603	CRCW060352K3FKEA	Vishay-Dale
R5	1	49.9k	RES, 49.9 k, 1%, 0.1 W, 0603	0603	CRCW060349K9FKEA	Vishay-Dale
R6, R8	2	0	RES, 0, 5%, 0.1 W, 0603	0603	MCR03EZPJ000	Rohm
SH-J3	1	1x2	Shunt, 100mil, Gold plated, Black	Shunt	969102-0000-DA	3M
TP1, TP2, TP3, TP4, TP5, TP6, TP7, TP8, TP9, TP10	10	SMT	Test Point, Miniature, SMT	Testpoint_Keystone_Miniature	5015	Keystone
U1	1		4.5V to 17V Input, 12A Synchronous Step-Down Converter, RNN0017A	RNN0017A	TPS56C215RNNR	Texas Instruments
FID1, FID2, FID3	0		Fiducial mark. There is nothing to buy or mount.	Fiducial	N/A	N/A
R1	0	57.6k	RES, 57.6 k, 1%, 0.1 W, 0603	0603	CRCW060357K6FKEA	Vishay-Dale
R2	0	12.1k	RES, 12.1 k, 1%, 0.1 W, 0603	0603	CRCW060312K1FKEA	Vishay-Dale

5 Revision History

NOTE: Page numbers for previous revisions may differ from page numbers in the current version.

Changes from Revision B (August 2017) to Revision C (June 2021)		Page
• Updated user's guide title.....		2
• Updated the numbering format for tables, figures, and cross-references throughout the document.		2
Changes from Revision A (April 2016) to Revision B (August 2017)		Page
• Changed pin 17 and pin 18 in the <i>TPS56C215EVM-762 Schematic</i>		16
Changes from Revision * (March 2016) to Revision A (April 2016)		Page
• Changed Figure 4-1		16

IMPORTANT NOTICE AND DISCLAIMER

TI PROVIDES TECHNICAL AND RELIABILITY DATA (INCLUDING DATA SHEETS), DESIGN RESOURCES (INCLUDING REFERENCE DESIGNS), APPLICATION OR OTHER DESIGN ADVICE, WEB TOOLS, SAFETY INFORMATION, AND OTHER RESOURCES "AS IS" AND WITH ALL FAULTS, AND DISCLAIMS ALL WARRANTIES, EXPRESS AND IMPLIED, INCLUDING WITHOUT LIMITATION ANY IMPLIED WARRANTIES OF MERCHANTABILITY, FITNESS FOR A PARTICULAR PURPOSE OR NON-INFRINGEMENT OF THIRD PARTY INTELLECTUAL PROPERTY RIGHTS.

These resources are intended for skilled developers designing with TI products. You are solely responsible for (1) selecting the appropriate TI products for your application, (2) designing, validating and testing your application, and (3) ensuring your application meets applicable standards, and any other safety, security, regulatory or other requirements.

These resources are subject to change without notice. TI grants you permission to use these resources only for development of an application that uses the TI products described in the resource. Other reproduction and display of these resources is prohibited. No license is granted to any other TI intellectual property right or to any third party intellectual property right. TI disclaims responsibility for, and you will fully indemnify TI and its representatives against, any claims, damages, costs, losses, and liabilities arising out of your use of these resources.

TI's products are provided subject to [TI's Terms of Sale](#) or other applicable terms available either on ti.com or provided in conjunction with such TI products. TI's provision of these resources does not expand or otherwise alter TI's applicable warranties or warranty disclaimers for TI products.

TI objects to and rejects any additional or different terms you may have proposed.

Mailing Address: Texas Instruments, Post Office Box 655303, Dallas, Texas 75265
Copyright © 2022, Texas Instruments Incorporated