



Main

Range of Product	Alstart 22
Product or Component Type	Soft starter
Product destination	Asynchronous motors
Product Specific Application	Pumps and fans
Component name	ATS22
Phase	3 phase
[Us] rated supply voltage	208...600 V - 15...10 %
Maximum Horse Power Rating	100 Hp 208 V 125 Hp 230 V 250 Hp 460 V 300 hp 575 V
Factory setting current	302 A
Power dissipation in W	150 W for standard applications
Utilisation category	AC-53A
Type of start	Start with torque control (current limited to 3.5 In)
lcl starter rating	320 A connection in the motor supply line for standard applications
IP Degree of Protection	IP00

Complementary

Assembly style	With heat sink
Function Available	Internal bypass
Supply voltage limits	177...660 V
Supply frequency	50...60 Hz - 10...10 %
Network Frequency	45...66 Hz
Device connection	In the motor supply line
[Uc] control circuit voltage	110 V - 15...10 % 50/60 Hz
Control circuit consumption	20 W
Discrete output number	2
Discrete output type	Relay outputs R1 230 V running, alarm, trip, stopped, not stopped, starting, ready C/O Relay outputs R2 230 V running, alarm, trip, stopped, not stopped, starting, ready C/O
Minimum switching current	100 mA 12 V DC relay outputs)
Maximum switching current	5 A 250 V AC resistive 1 relay outputs 5 A 30 V DC resistive 1 relay outputs 2 A 250 V AC inductive 0.4 20 ms relay outputs 2 A 30 V DC inductive 7 ms relay outputs
Discrete input number	3
Discrete input type	LI1, LI2, LI3) logic, 5 mA 20 kOhm
Discrete input voltage	110 V <= 121 V
Discrete input logic	Positive logic LI1, LI2, LI3 < 20 V <= 15 mA > 79 V, <= 2 mA
Output current	0.4...1 lcl adjustable
PTC probe input	750 Ohm
Communication Port Protocol	Modbus
Connector type	1 RJ45
Communication data link	Serial

The information provided in this documentation contains general descriptions and/or technical characteristics of the performance of the products contained herein. This documentation is not intended as a substitute for and is not to be used for determining suitability or reliability of these products for specific user applications. It is the duty of any such user or integrator to perform the appropriate and complete risk analysis, evaluation and testing of the products with respect to the relevant specific application or use thereof. Neither Schneider Electric Industries SAS nor any of its affiliates or subsidiaries shall be responsible or liable for misuse of the information contained herein.

Physical interface	RS485 multidrop
Transmission Rate	4800, 9600 or 19200 bps
Installed device	31
Protection type	Phase failure line Thermal protection motor Thermal protection starter
Marking	CE
Type of cooling	Forced convection
Operating position	Vertical +/- 10 degree
Height	16.73 in (425 mm)
Width	8.11 in (206 mm)
Depth	11.77 in (299 mm)
Net Weight	72.75 lb(US) (33 kg)

Environment

Electromagnetic compatibility	Conducted and radiated emissions level A IEC 60947-4-2 Damped oscillating waves level 3 IEC 61000-4-12 Electrostatic discharge level 3 IEC 61000-4-2 Immunity to electrical transients level 4 IEC 61000-4-4 Immunity to radiated radio-electrical interference level 3 IEC 61000-4-3 Voltage/current impulse level 3 IEC 61000-4-5
Standards	EN/IEC 60947-4-2
Product Certifications	CSA C-tick CCC UL GOST
Vibration resistance	1 gn 13...200 Hz)EN/IEC 60068-2-6 1.5 mm 2...13 Hz)EN/IEC 60068-2-6
Shock resistance	15 gn 11 ms EN/IEC 60068-2-27
Noise level	56 dB
Pollution degree	Level 2 IEC 60664-1
Relative humidity	0...95 % without condensation or dripping water EN/IEC 60068-2-3
Ambient air temperature for operation	14...104 °F (-10...40 °C) without derating) 104...140 °F (40...60 °C) with current derating 2.2 % per °C)
Ambient Air Temperature for Storage	-13...158 °F (-25...70 °C)
Operating altitude	<= 3280.84 ft (1000 m) without derating > 3280.84...< 6561.68 ft (> 1000...< 2000 m) with current derating of 2.2 % per additional 100 m

Ordering and shipping details

Category	22576 - ATS22 ALTISTART
Discount Schedule	CP1G
GTIN	3606480211218
Nbr. of units in pkg.	1
Package weight(Lbs)	54.01 lb(US) (24.5 kg)
Returnability	Yes
Country of origin	CN

Packing Units

Unit Type of Package 1	PCE
Package 1 Height	18.11 in (46 cm)
Package 1 width	15.75 in (40 cm)
Package 1 Length	23.62 in (60 cm)
Unit Type of Package 2	P06
Number of Units in Package 2	2
Package 2 Weight	126.77 lb(US) (57.5 kg)
Package 2 Height	30.31 in (77 cm)
Package 2 width	31.50 in (80 cm)
Package 2 Length	23.62 in (60 cm)

Offer Sustainability

Sustainable offer status	Green Premium product
California proposition 65	WARNING: This product can expose you to chemicals including: Lead and lead compounds, which is known to the State of California to cause cancer and birth defects or other reproductive harm. For more information go to www.P65Warnings.ca.gov
REACH Regulation	REACH Declaration
EU RoHS Directive	Pro-active compliance (Product out of EU RoHS legal scope) EU RoHS Declaration
Mercury free	Yes
RoHS exemption information	Yes
China RoHS Regulation	China RoHS Declaration
Environmental Disclosure	Product Environmental Profile
Circularity Profile	End Of Life Information
WEEE	The product must be disposed on European Union markets following specific waste collection and never end up in rubbish bins.

Contractual warranty

Warranty	18 months
----------	-----------

Frame Size D

Dimensions

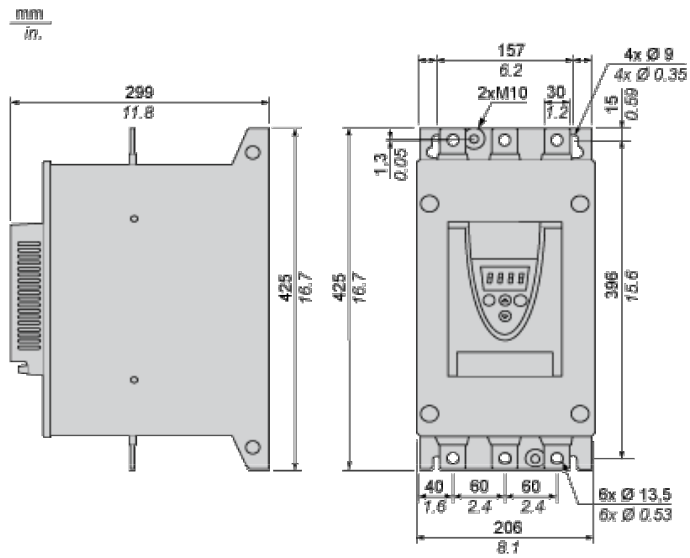

Precautions

Standards

The Altistart 22 soft starter is compliant with pollution Degree 2 as defined in NEMA ICS1-1 or IEC 60664-1.
For environment pollution degree 3, install the Altistart 22 soft starter inside a cabinet type 12 or IP54.

⚠ DANGER

HAZARD OF ELECTRIC SHOCK, EXPLOSION, OR ARC FLASH

ATS22 soft starters are open devices and must be mounted in a suitable enclosure.

Failure to follow these instructions will result in death or serious injury.

Air Circulation

Leave sufficient free space to help the air required for cooling purposes to circulate from the bottom to the top of the unit.

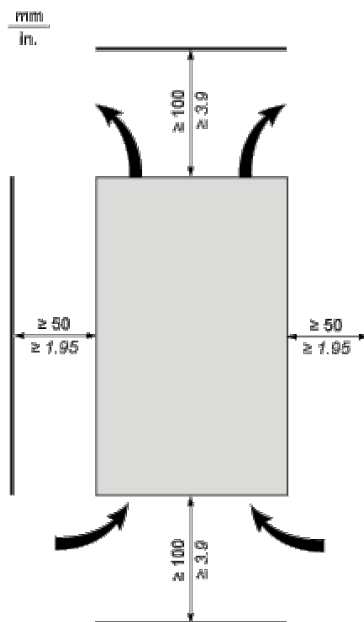

Overheating

To avoid the soft starter to overheat, respect the following recommendations:

- Mount the Altistart 22 Soft Starter within $\pm 10^\circ$ of vertical.
- Do not locate the Altistart 22 Soft Starter near heat radiating elements.
- Electrical current through the Altistart 22 Soft Starter will result in heat losses that must be dissipated into the ambient air immediately surrounding the soft starter. To help prevent a thermal fault, provide sufficient enclosure cooling and/or ventilation to limit the ambient temperature around the soft starter.
- If several soft starters are installed in a control panel, arrange them in a row. Do not stack soft starters. Heat generated from the bottom soft starter can adversely affect the ambient temperature around the top soft starter.

Wall mounted or Floor-standing Enclosure with IP 23 Degree of protection

Introduction

To help proper air circulation in the soft starter, grilles and forced ventilation can be installed.

Ventilation Grilles

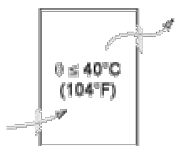

Forced Ventilation Unit

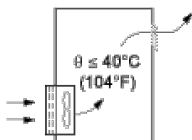

Power Terminal

Bar Style

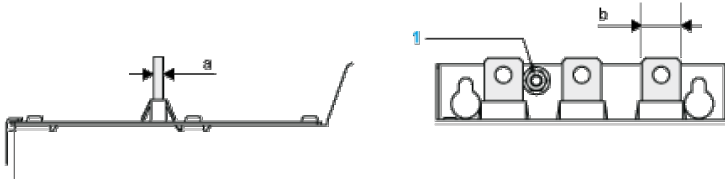

Power supply and output to motor	Bar	b	30 mm (1.18 in)
a	5 mm (0.2 in)		
Bolt	M12 (0.47 in)		
Cable and protective cover	Size	2X150 mm ²	
Gauge	2X250 MCM		
Protective cover	LA9F703		
Tightening torque	57 N.m		
498.75 lb.in			

Power connections, minimum required wiring section

IEC cable mm ² (Cu 70°C/158°F) (1)	UL cable AWG (Cu 75°C/167°F) (1)
185	2 X 3/0

110 Vac control, Logic Inputs (LI) 110 Vac, 3-wire control

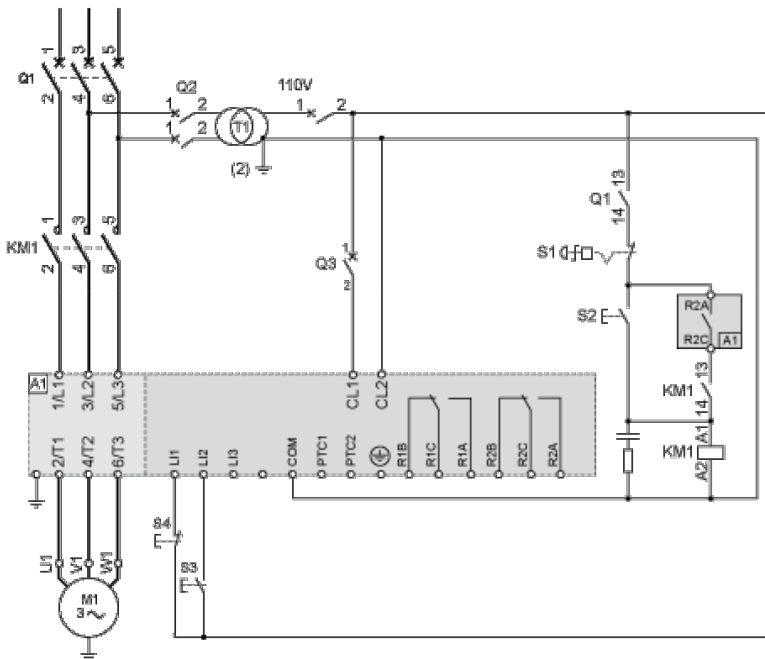

110 Vac control, Logic Inputs (LI) 110 Vac, 2-wire control, freewheelstop

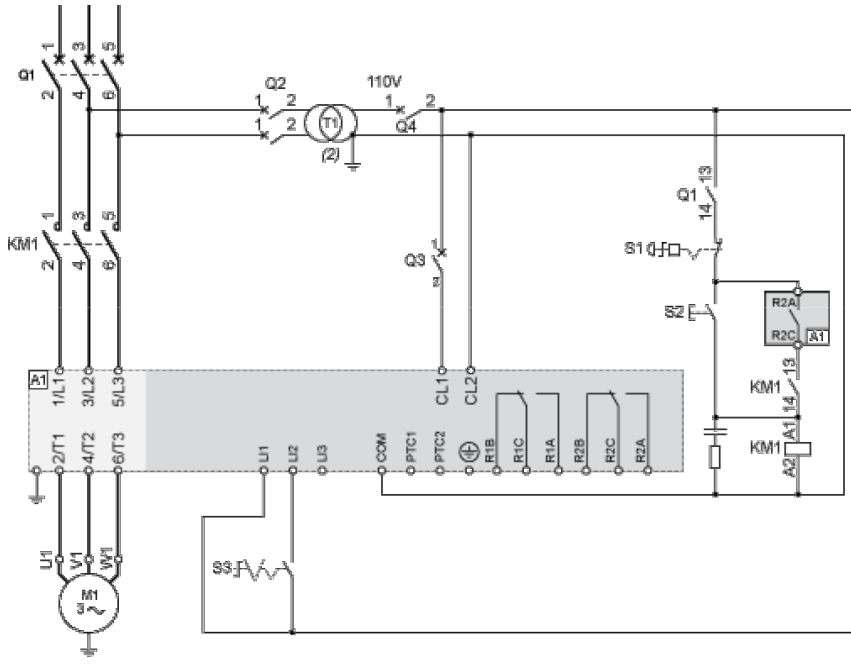

Motor Thermal Protection - Cold Curves

Curves

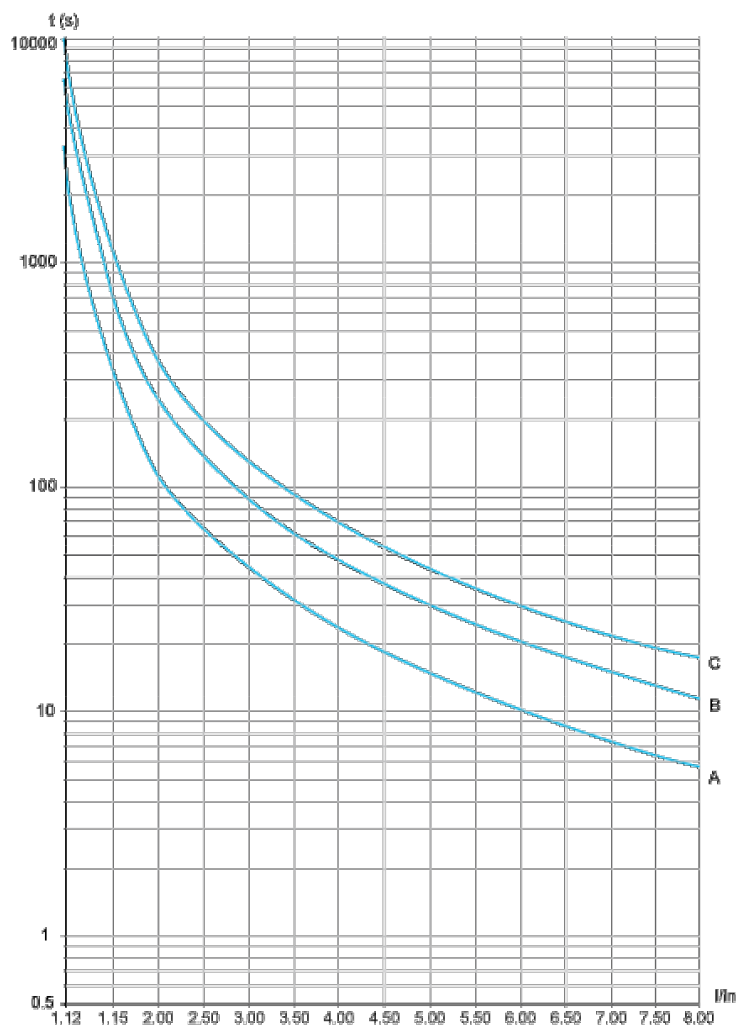

- A Class 10
- B Class 20
- C Class 30

Trip time for a Standard Application (Class 10)

3.5 In
32 s

Trip time for a Severe Application (Class 20)

3.5 In
63 s

Trip time for a Severe Application (Class 30)

3.5 In
95 s

Curves

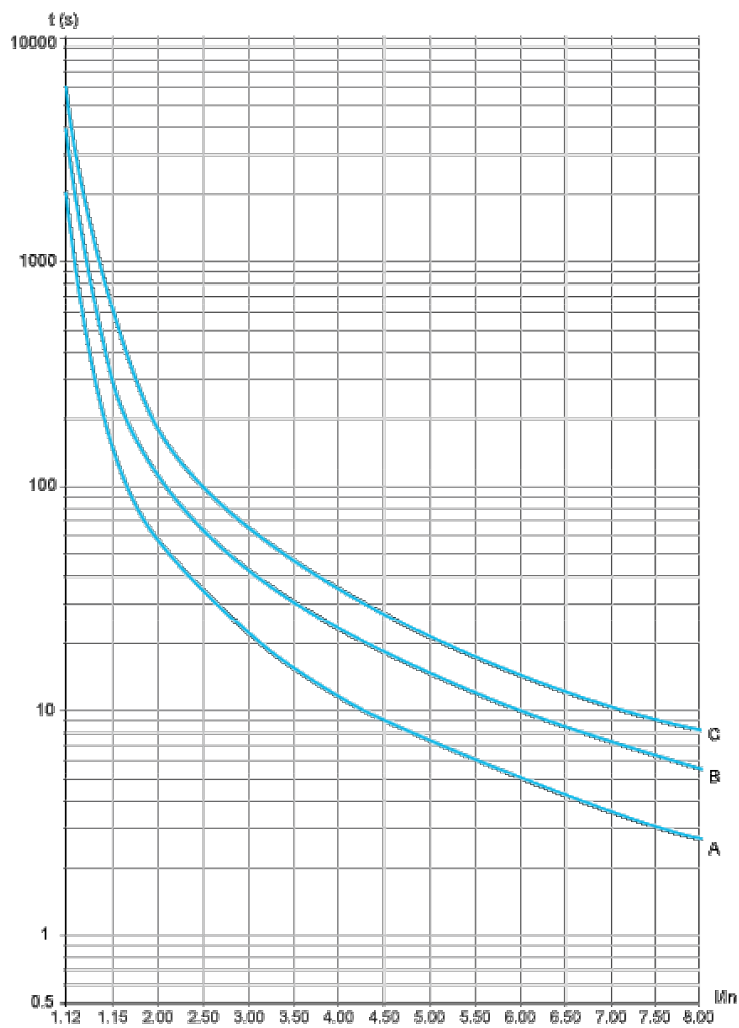

- A Class 10
- B Class 20
- C Class 30

Trip time for a Standard Application (Class 10)

3.5 In
16 s

Trip time for a Severe Application (Class 20)

3.5 In
32 s

Trip time for a Severe Application (Class 30)

3.5 In
48 s