



KYOCERA Display Corporation

APPROVAL SHEET

承認書

Customer 客戶名稱	
Part No. 產品型號	TVL-55731GD032J-LW-G-AAN
Product type 產品內容	Mode: 3.2 inch WQVGA TFT Transmissive Type , Positive mode RGB vertical stripe 262K color / 65K color
RoHS 綠色產品	<input type="checkbox"/> Non-compliance <input checked="" type="checkbox"/> Compliance
Remarks 備註欄	
<input checked="" type="checkbox"/> Preliminary Specification 暫行規格 <input type="checkbox"/> Final Specification 正式規格 Signature by Customer: 客戶確認簽章:	

Issued by QA	Checked by QA	Checked by PM	Approved By	
			QA	RD

Specification of LCD Module

Product No.: **TVL-55731GD032J-LW-G-AAN**

Issue date : 2013/02/21

KYOCERA DISPLAY CORPORATION

5-7-18, Higashinippori Arakawa-ku ,
Tokyo 116-0014, Japan
TEL: +81-3-5811-8780
FAX: +81-3-5811-8782



KYOCERA Display Corporation

TABLE OF CONTENTS

1. GENERAL DESCRIPTION.....	4
2. FEATURES.....	4
3. MECHANICAL SPECIFICATION.....	4
MECHANICAL DIMENSION.....	5
4. MODULE FUNCTION DESCRIPTION.....	6
5. MAXIMUM RATINGS.....	8
6. ELECTRICAL CHARACTERISTIC.....	8
7. BACKLIGHT CHARACETRISTIC.....	9
7.1. Characteristic.....	9
8. MPU SYSTEM INTERFACE.....	9
8.1. DBI 16-bit interface.....	9
8.2. DBI Type B (18/16/9/8 bit) Interface Timing Characteristics.....	9
8.3. Display ON/OFF Sequence.....	9
8.4. Block diagram of LCD.....	9
8.5. Command Summary(Reference).....	9
9. ELECTRO-OPTICAL CHARACTERISTICS.....	9
9.1. Optical characteristics.....	9
9.2. CIE(x, y) chromaticity.....	9
10. RELIABILITY.....	9
10.1. MTTF.....	9
10.2. Tests.....	9
10.3. Color Performance.....	9
11. INSPECTION CRITERIA.....	9
11.1. Inspection Conditions.....	9
11.2. Light Method.....	9
11.3. Classification Of Defects.....	9



KYOCERA Display Corporation

11.4.	Sampling & Acceptable Quality Level	9
11.5.	Definition Of Inspection Area	9
11.6.	Items and Criteria.....	9
12.	ILLUSTRATION OF LCD DATE CODE	9
13.	ROHS COMPLIANT WARRANTY	9
14.	PRECAUTIONS FOR USE.....	9
14.1.	Safety.....	9
14.2.	Storage Conditions	9
14.3.	Installing LCD Module.....	9
14.4.	Precautions For Operation.....	9
14.5.	Handling Precautions.....	9
14.6.	Guarantee	9
15.	FACTORY	9
16.	REVISION HISTORY	9



KYOCERA Display Corporation

1. GENERAL DESCRIPTION

TVL-55731GD032J-LW-G-AAN is a Color TFT LCD supplied by KYOCERA DISPLAY. This main Module has a 3.2 inch diagonally measured active display area with 240 X RGB X 400 resolutions. Each pixel is divided into Red, Green and Blue sub-pixels and dots that are arranged in vertical stripes. LCD color is determined with Dithering 65K/262K Color signal for each pixel. The module has been designed to apply the interface method that enables low power, high speed, and high contrast. The LCM is intended to support applications where thin thickness, wide viewing angle, low power are critical factors and graphic displays are important.

2. FEATURES

Display Mode	Transmissive Type
	a-Si color TFT LCD, Normally white type
Screen Size	3.2 inch WQVGA
Display Format	Graphic 240*RGB*400 Stripe type
Color	65K/262K color
Interface	MCU 16 bit Interface
Driver IC	ILI9327-1
Backlight type / color	White LED
Viewing Direction	Higher Contrast ratio: 6 o'clock
	Less gray scale reversal: 12 o'clock

3. MECHANICAL SPECIFICATION

Item	Specifications	Unit
Dimensional outline	47.4(H)×81.2(V)×2.3(t)	mm
Resolution	240×(R, G, B)×400	dot
Active area	41.76(W)×69.6(H)	mm
Pixel pitch	0.174 (W)×0.174(H)	mm

*1: Exclude FPC & Components(Max=0.8mm)

MECHANICAL DIMENSION

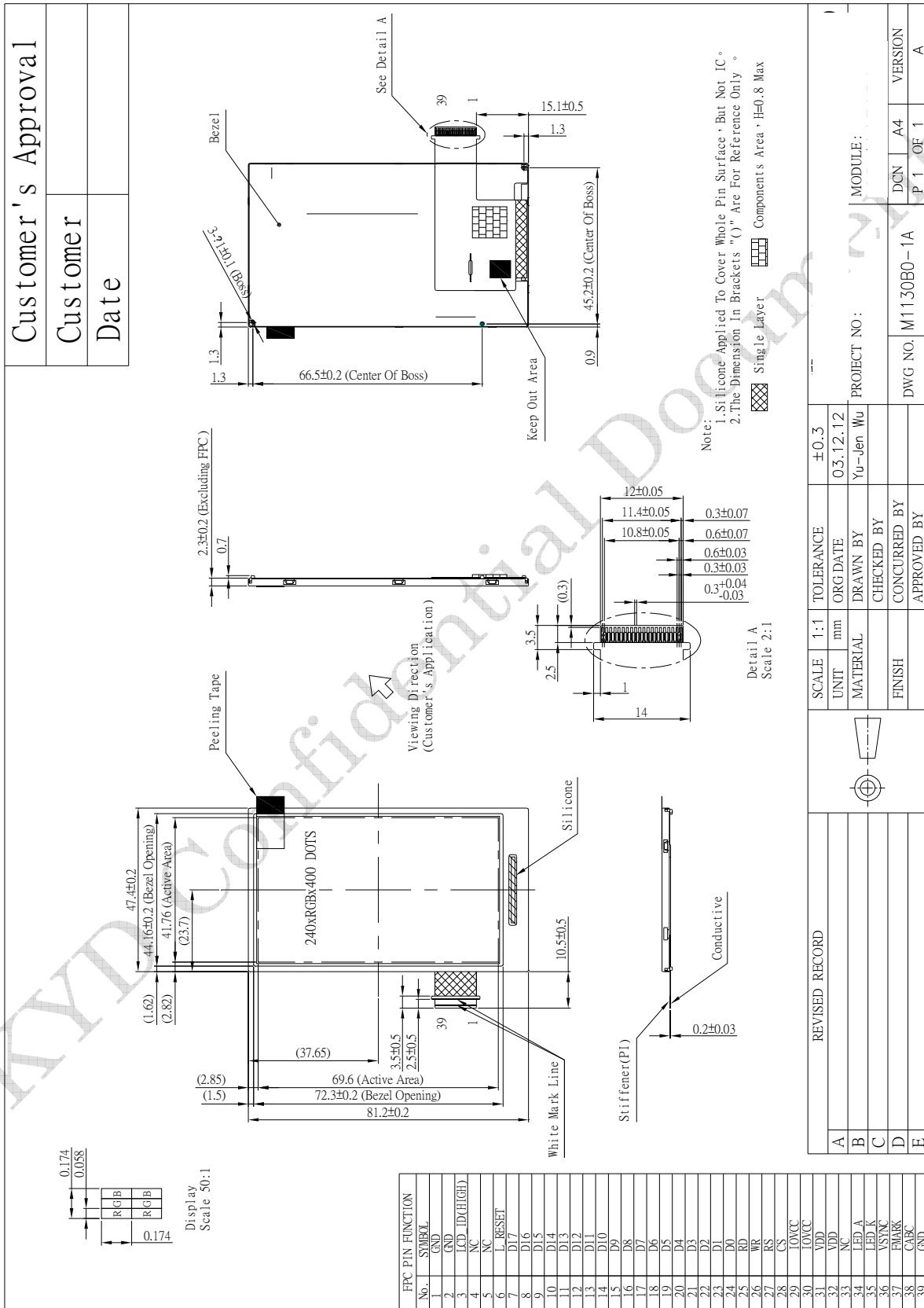



KYOCERA Display Corporation

4. MODULE FUNCTION DESCRIPTION

Pin No.	Pin name	Description
1	GND	Power ground
2	GND	Power ground
3	LCD_ID(H)	ID PIN, High Level
4	NC	No connection
5	NC	No connection
6	RESET	This signal low will reset the device and must be applied to properly initialize the chip. Signal is low active
7	DB17	DBI type B 16-bit interface: [D15:D0] = [DB15:DB0] Unused pin must be fixed "GND" level.
8	DB16	
9	DB15	
10	DB14	
11	DB13	
12	DB12	
13	DB11	
14	DB10	
15	DB9	
16	DB8	
17	DB7	
18	DB6	
19	DB5	
20	DB4	
21	DB3	
22	DB2	
23	DB1	
24	DB0	
25	RD	Read control pin. If unused, connect this pin to IOVCC.
26	WR	Write control pin. If unused, connect this pin to IOVCC.
27	RS (DCX)	Display data / Command selection pin D/CX='1': Display data. D/CX='0': Command data. If not used, please fix this pin at GND level.



KYOCERA Display Corporation

Pin No.	Pin name	Description
28	CS	Chip select input pin ("Low" enable).When it is not used, please fix this pin at IOVCC.
29	IOVCC	Digital I/O power supply
30	IOVCC	
31	VDD	Power supply
32	VDD	
33	NC	No connection
34	LED-A(+)	Backlight power terminal—Anode
35	LED-K(-)	Backlight power terminal—Cathode
36	VSYNC (S_CS)	Vertical sync. Signal in DPI interface mode. If it's not used; please fix this pin as GND.
37	FMARK	Output a frame head plus signal. It is used when writing RAM data in synchronization with frame. Leave this pin open when not in use.
38	CABC	Backlight PWM signal
39	GND	Power ground



KYOCERA Display Corporation

5. MAXIMUM RATINGS

If the operating condition exceeds the following absolute maximum ratings, the TFT LCD module may be damaged permanently.

Item	Symbol	Values		Unit	Note
		Min.	Max.		
Power Supply for Analog	VDD-GND	-0.3	4.6	V	
power supply for Digital	IOVCC- GND	-0.3	4.6	V	
Storage Temperature	T _{ST}	-30	80	°C	Ambient temperature
Operating Temperature (Ambient Temperature)	T _{OP}	-20	70	°C	Ambient temperature
Humidity	-	-	90	%RH	Note 3)

Note :

- 1) All the voltages listed above are with respective to GND=0V ◦
- 2) Device is subject to be damaged permanently if stresses beyond those absolute maximum ratings listed above ◦
- 3) T_A ≤ 40°C Without dewing

6. ELECTRICAL CHARACTERISTIC

A. Typical operating conditions (GND=0V)

Item	Symbol	Values			Unit	Remark
		Min.	Typ.	Max.		
IC Power Voltage	VDD	2.5	-	3.6	V	
IC I/O Pin Power Voltage	IOVCC	1.65	-	3.6		
High-level Input Voltage	V _{IH}	0.7*IOVCC	-	IOVCC	V	
Low-level Input Voltage	V _{IL}	0	-	0.3* IOVCC	V	
High-level Output Voltage	V _{OH}	0.8*IOVCC	-	IOVCC	V	
Low-level Output Voltage	V _{OL}	0	-	0.2*IOVCC	V	
Consumption current of V _{DD}	I _{DD}	-	12.8	19.5	mA	
Current consumption during Sleep operation	I _{st}	-	(50)	-	uA	

Note1 : VDD = VCI

7. BACKLIGHT CHARACTERISTIC

7.1. Characteristic

Item	Symbol	Conditions	Values			Unit	Remark
			Min.	Typ.	Max.		
Forward voltage	V_{LED}	$T_a=25^{\circ}C$ $I_{LED}=20mA$	2.8	3.2	3.6	V	Each LED
Forward current	I_{LED}	$T_a=25^{\circ}C$	-	20	-	mA	Each LED
Power consumption of backlight module	P_{LED}	$T_a=25^{\circ}C$ $I_{LED}=20mA$	336	384	432	mW	
Chip connection	6-chip serial connection						

Backlight LED connection:

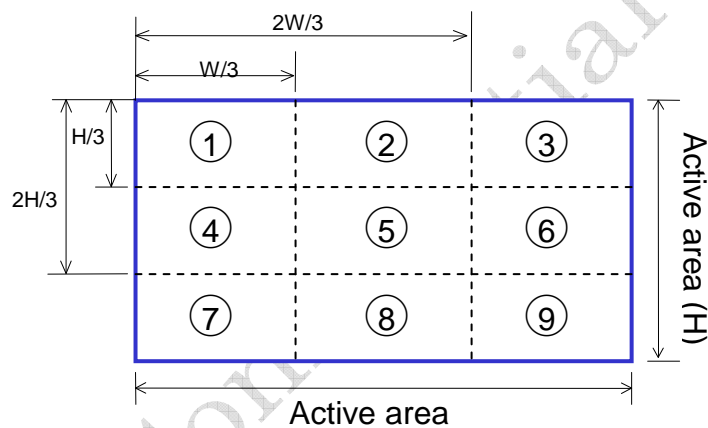

- Test Instrument: BM-7 (Distance =500mm; Field = 1°)
- Light Source: LED * 6(White)
- Conditions: $V_f = 19\sim 20.1V$; $I_f = 20\text{ mA}$
- Measure Brightness: 1 ~ 9
- Uniformity = (Min. Brightness / Max. Brightness)*100%
- Uniformity $\geq 80\%$

8. MPU SYSTEM INTERFACE

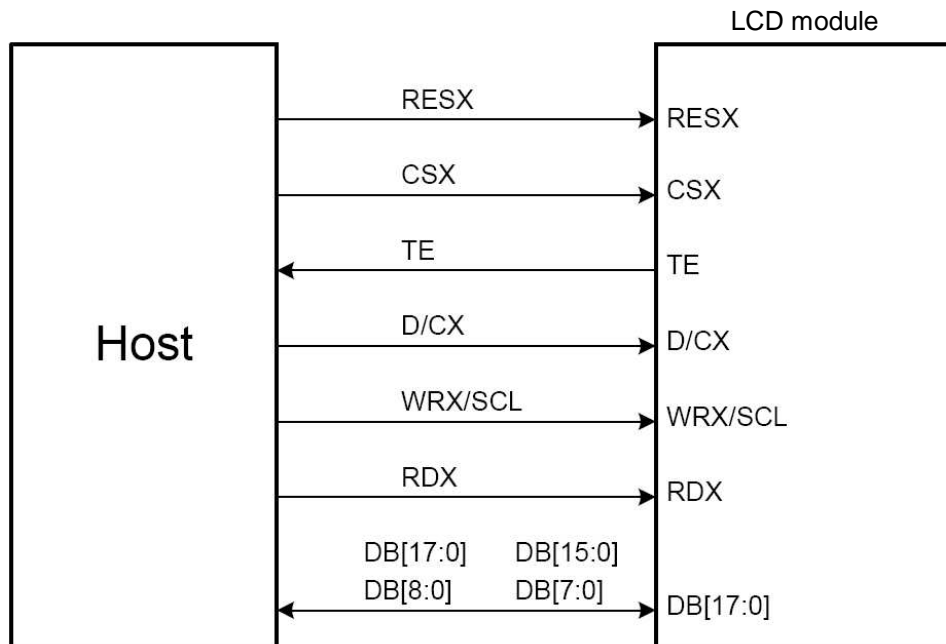

8.1. DBI 16-bit interface

16-bit data bus DB[15:0] interface, IM[2:0] = 010

Set_pixel_format	DFM	DB15	DB14	DB13	DB12	DB11	DB10	DB9	DB8	DB7	DB6	DB5	DB4	DB3	DB2	DB1	DB0
Command/Parameter Write	*									D[7]	D[6]	D[5]	D[4]	D[3]	D[2]	D[1]	D[0]
Command/Parameter Read	*									D[7]	D[6]	D[5]	D[4]	D[3]	D[2]	D[1]	D[0]

Set_pixel_format	DFM	DB15	DB14	DB13	DB12	DB11	DB10	DB9	DB8	DB7	DB6	DB5	DB4	DB3	DB2	DB1	DB0
16bpp Frame Memory Write	*	R[4]	R[3]	R[2]	R[1]	R[0]	G[5]	G[4]	G[3]	G[2]	G[1]	G[0]	B[4]	B[3]	B[2]	B[1]	B[0]
16bpp Frame Memory Read	*	r[4]	r[3]	r[2]	r[1]	r[0]	g[5]	g[4]	g[3]	g[2]	g[1]	g[0]	b[4]	b[3]	b[2]	b[1]	b[0]



KYOCERA Display Corporation

8.2. DBI Type B (18/16/9/8 bit) Interface Timing Characteristics

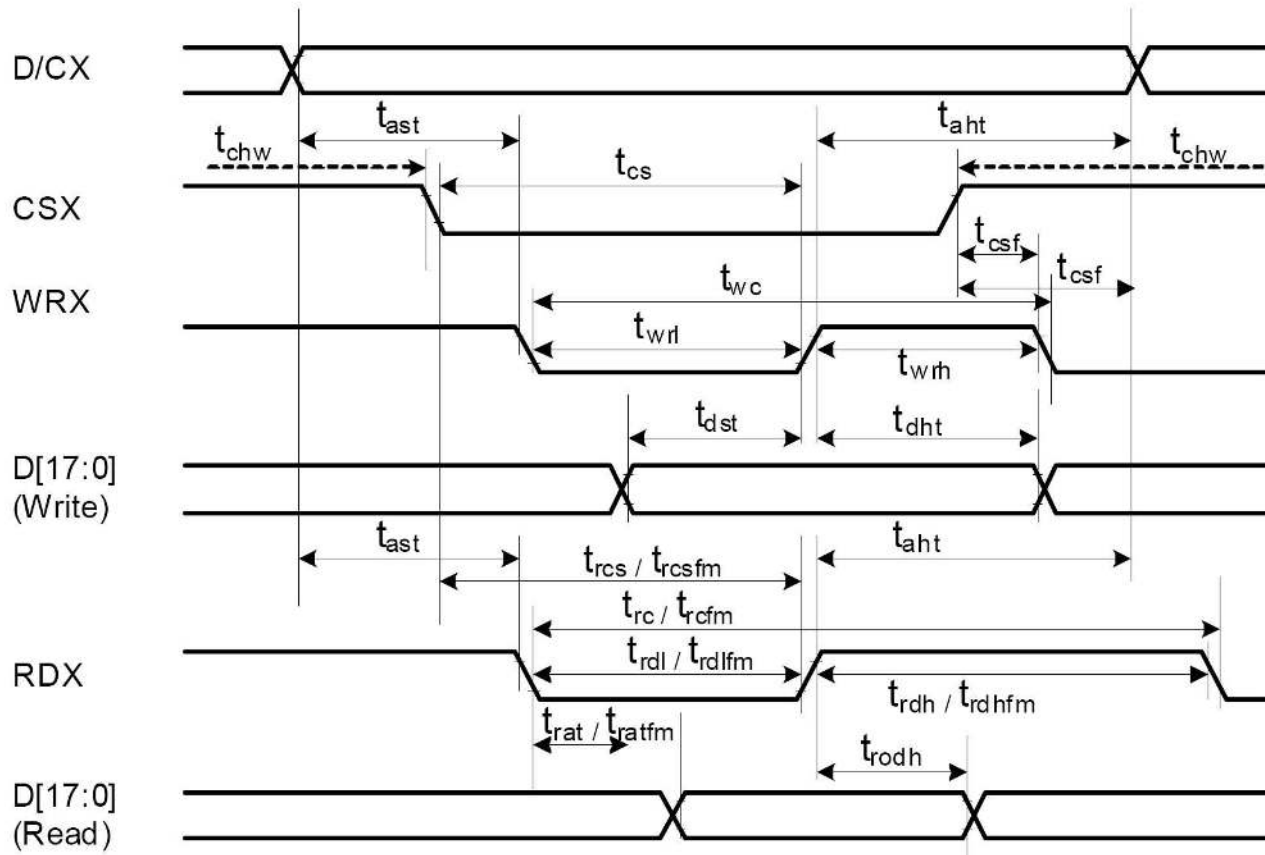

Signal	Symbol	Parameter	min	max	Unit	Description
D/CX	t_{ast}	Address setup time	0	-	ns	
	t_{ah}	Address hold time (Write/Read)	10	-	ns	
CSX	t_{chw}	CSX "H" Pulse Width	0	-	ns	
	t_{cs}	Chip Select setup time (Write)	20	-	ns	
	t_{rcs}	Chip Select setup time (Read ID)	45	-	ns	
	t_{rcsfm}	Chip Select setup time (Read FM)	355	-	ns	
	t_{csf}	Chip Select Wait time (Write/Read)	10	-	ns	
WRX	t_{wc}	Write cycle	80	-	ns	
	t_{wrh}	Write Control pulse H duration	25	-	ns	
	t_{wrl}	Write Control pulse L duration	25	-	ns	
RDX (ID)	t_{rc}	Read cycle (ID)	160	-	ns	
	t_{rdh}	Read Control pulse H duration (ID)	90	-	ns	
	t_{rdl}	Read Control pulse L duration (ID)	45	-	ns	
RDX (FM)	t_{rcfm}	Read cycle (FM)	450	-	ns	
	t_{rdhfm}	Read Control pulse H duration (FM)	90	-	ns	
	t_{rdlfm}	Read Control pulse L duration (FM)	355	-	ns	
DB[17:0], DB[15:0], DB[8:0], DB[7:0]	t_{dst}	Data setup time	10	-	ns	For maximum CL=30pF For minimum CL=8pF
	t_{dht}	Data hold time	10	-	ns	
	t_{rat}	Read access time (ID)	-	40	ns	
	t_{ratfm}	Read access time (FM)	-	340	ns	
	t_{odh}	Output disable time	20	-	ns	

Note1: $T_a = -30$ to 70 °C, $V_{DD} = 2.5V$ to $3.0V$, $DGND = 0V$



KYOCERA Display Corporation

Note2: Logic high and low levels are specified as 30% and 70% of VCC for Input signals.

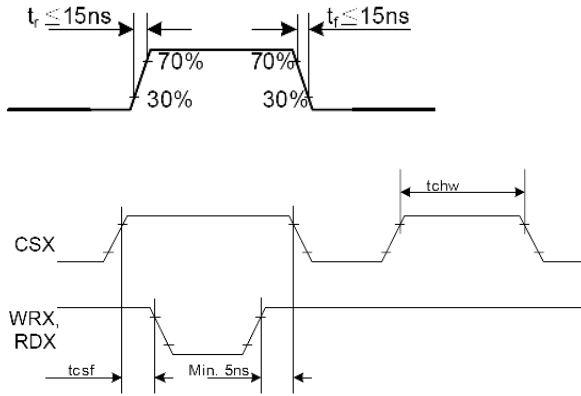

KYD Confidential Document



KYOCERA Display Corporation

8.3. Display ON/OFF Sequence

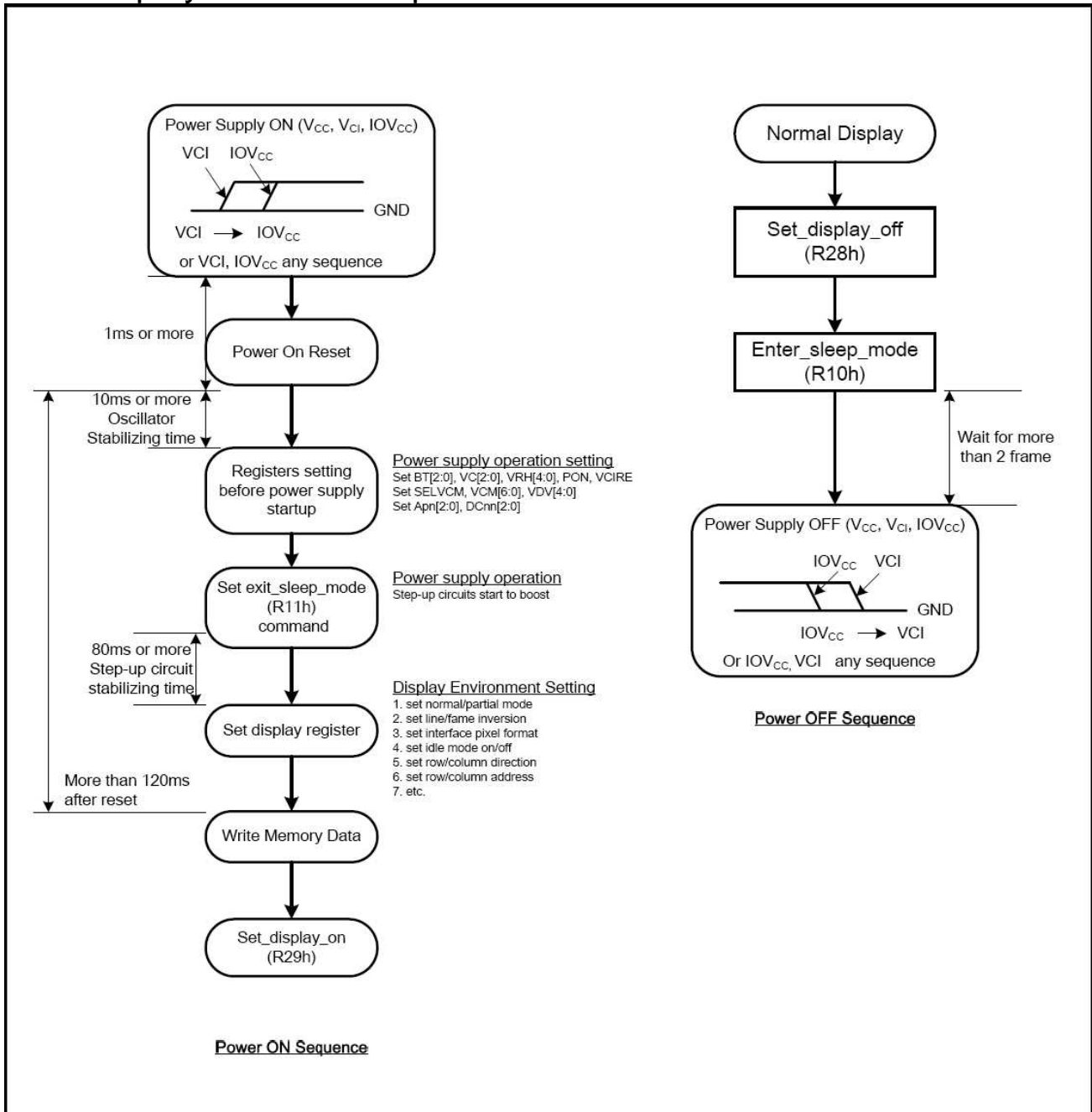

8.4. Block diagram of LCD

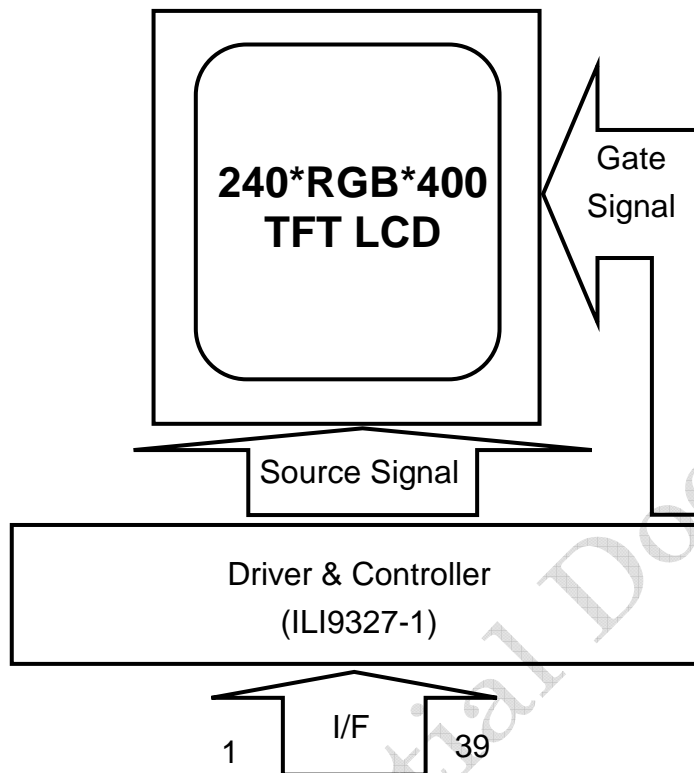

8.5. Command Summary(Reference)

Instruction		Command	Code	Description
1	Set internal timing	00E9	0020	RAM clock adjust
2	Exit sleep mode	0011	/	
Delay 100mS				
3	VCOM Control	00D1	0000	Selection the VCM setting.
			0072	Generate VCOMH voltage from the reference voltage VREG1OUT.
			0019	VCOM alternating amplitude
4	Power Setting	00D0	0007	Sets the ratio factor of Vci to generate the reference voltages Vci1.
			0001	Sets the Step up factor and output voltage level from the reference voltages Vci1.
			0004	Sets the factor to generate VREG1OUT from VCI



KYOCERA Display Corporation

Instruction		Command	Code	Description
5	Set address mode	0036	0048	This command defines read/ write scanning direction of frame memory.
6	Set pixel format	003A	0055	This command sets the pixel format for the RGB image data used by the interface. Bits D[6:4] – DPI Pixel Format Definition Bits D[2:0] – DBI Pixel Format Definition Bits D7 and D3 are not used.
7	Display Timing Setting for Normal/Partial Mode	00C1	0010	Set division ratio of internal clock frequency.
			0010	Set 1H (line) period.
			0002	Set the number of lines for a back porch period (a blank period made before the beginning of display).
			0002	Set the number of lines for a front porch period (a blank period following the end of display).
8	Panel Driving Setting	00C0	0000	Set scan line direction
			0035	Sets the number of lines to drive the LCD at an interval of 8 lines.
			0000	Specifies the gate line where the gate driver starts scan
			0000	Set the source output level in non-display area drive period (front/back porch period and blank area between partial displays).
			0001	Set the scan cycle when PTG selects interval scan in non-display area drive period.
			0002	Set division ratio of PCLK clock frequency when the DPI interface is selected.
9	Frame Rate Control	00C5	0001	Set the frame frequency of display.
10	Power Setting for Normal Mode	00D2	0001	Adjust the constant current taking the trade-off between the display quality and the current consumption into account.
			0044	Select the charge-pump frequency of circuit and circuit2.



KYOCERA Display Corporation

Instruction		Command	Code	Description
11	Gamma Setting	00C8	0004	Set the Gamma curve.
			0057	
			0044	
			0004	
			000B	
			0001	
			0033	
			0002	
			0037	
			0040	
			0001	
			0013	
			0008	
0080				
0000				
12	Display on	0029	/	
13	Set column address	002A	0000	This command is used to define area of frame memory where MCU can access. This command makes no change on the other driver status.
			0000	
			0000	
			00EF	
14	Set page address	002B	0000	This command defines the page extent of the frame memory accessed by the host processor with the Write memory continue and read memory continue command. No status bits are changed.
			0000	
			0001	
			008F	
15	Write memory start	002C	/	This command transfers image data from the host processor to the display module's frame memory starting at the pixel location specified by preceding set column address (2Ah) and set page address (2Bh) commands.



KYOCERA Display Corporation

Instruction		Command	Code	Description
16	Write Display Brightness	0051	00FF	This command is used to adjust the brightness value of the display.
17	Write CTRL Display	0053	002C	This command is used to control display brightness.
18	Write Content Adaptive Brightness Control	0055	0002	This command is used to set parameters for image content based adaptive brightness control functionality.
19	Write CABC Minimum Brightness	005E	000F	This command is used to set the minimum brightness value of the display for CABC function.

9. ELECTRO-OPTICAL CHARACTERISTICS

9.1. Optical characteristics

LED backlight transmissive module:

Item	Symbol	Temp.	Min.	Typ.	Max.	Unit	Conditions
Response time	Tr + Tf	25°C	-	25	50	ms	$\theta = 0^\circ$, $\phi = 0^\circ$ (Note 1)
Contrast ratio	CR	25°C	300	400	-	-	$\theta = 0^\circ$, $\phi = 0^\circ$ LED:ON,LIGHT:OFF (Note 3)
Visual angle range front and rear	$\theta +$	25°C	-	60	-	Degree	Upper (Note 2)
	$\theta -$		-	50	-		Lower (Note 2)
Visual angle range left and right	$\phi +$	25°C	-	60	-	Degree	Right (Note 2)
	$\phi -$		-	60	-		Left (Note 2)
Visual angle direction priority			12"				Gray scale inversion (Note4)
Brightness			250	300	-	Cd/m ²	I _{LED} =20mA full White pattern

Note : TN TFT+TN polarizer



KYOCERA Display Corporation

9.2. CIE(x, y) chromaticity

Parameter		Symbol	Min.	Typ.	Max.	Note	
CIE color Coordinates	Red	Wx	(0.59)	(0.64)	(0.69)	BM5; 1° angle $\theta = 0^\circ, \psi = 0^\circ$	
		Wy	(0.29)	(0.34)	(0.39)		
	Green	Rx	(0.34)	(0.39)	(0.44)		
		Ry	(0.51)	(0.56)	(0.61)		
	Blue	Gx	(0.10)	(0.15)	0.20)		
		Gy	(0.02)	(0.07)	(0.12)		
	White	Bx	--	(0.33)	--		
		By	--	(0.32)	--		
	NTSC	%	55%				

NOTE 1: Response time definition

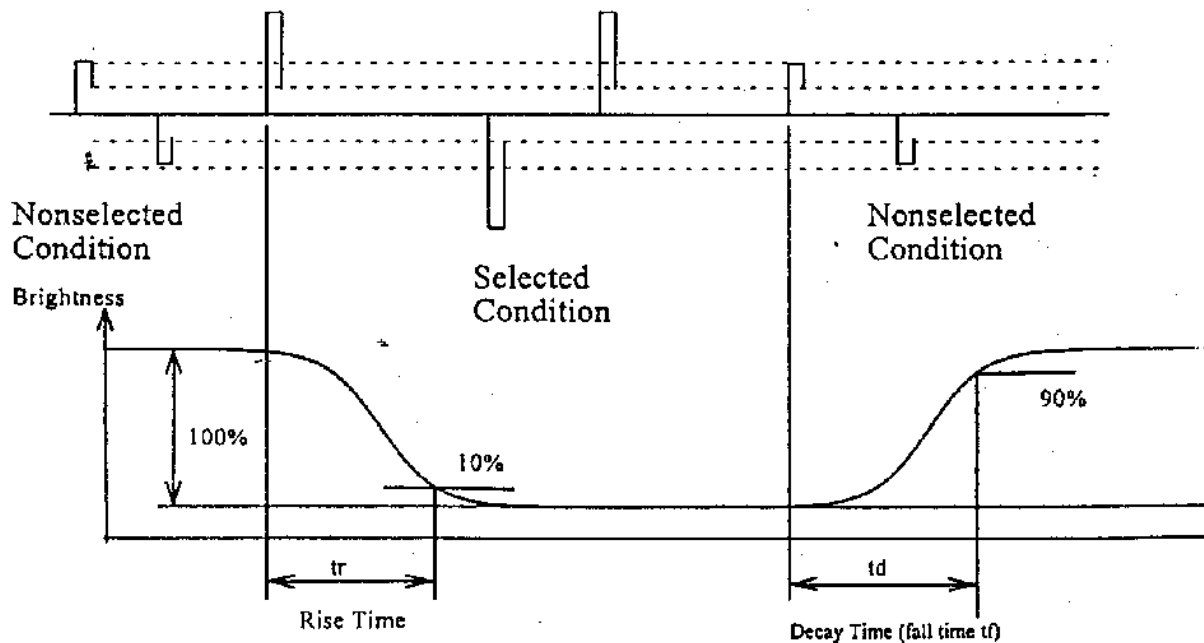

NOTE 2: ϕ 、 θ definition



KYOCERA Display Corporation

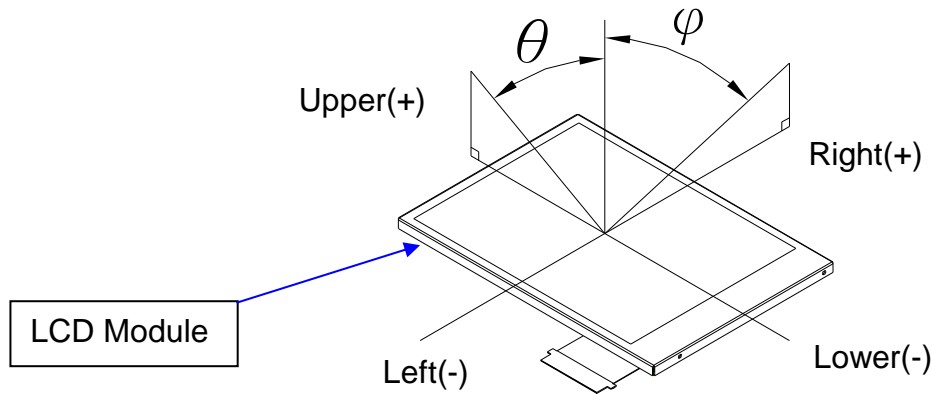

NOTE 3: Contrast Definition

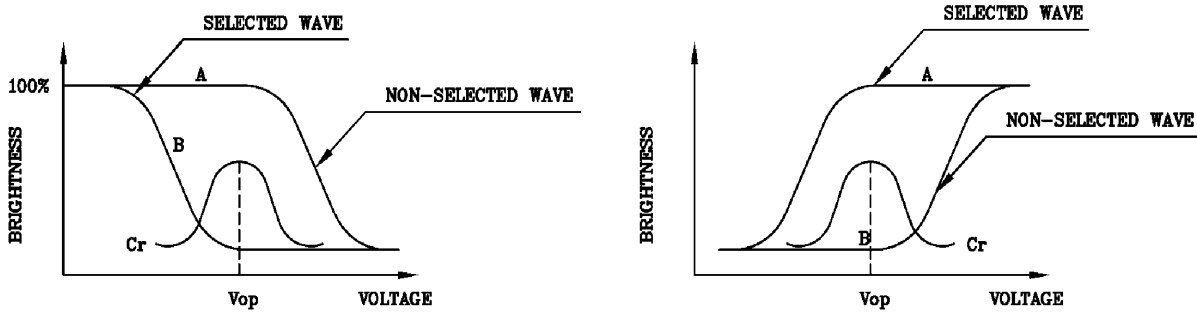

(positive type)

(negative type)

Contrast Ratio : $Cr = A/B$

NOTE 4: Visual angle direction priority

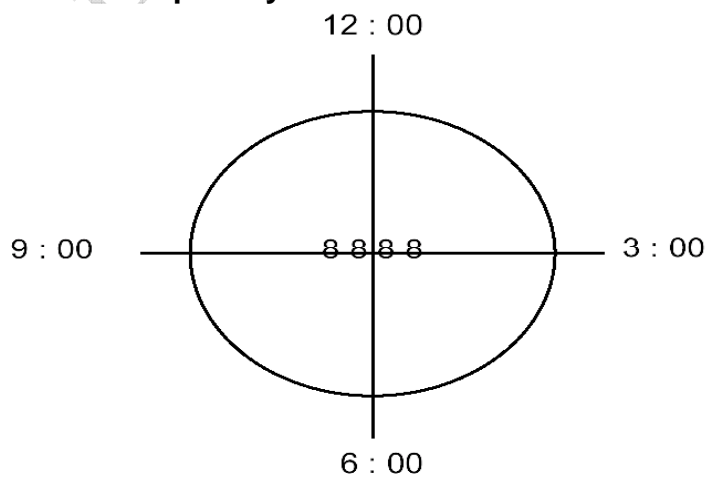



KYOCERA Display Corporation

10. RELIABILITY

10.1.MTTF

The LCD module shall be designed to meet a minimum MTTF value of 50,000 hours with normal condition. (25°C in the room without sunlight; not include lifetime of backlight and Touch Panel).

10.2. Tests

NO.	ITEM	CONDITION	CRITERION
1	High Temperature Operating	+70°C 240 hrs	<ul style="list-style-type: none"> ◦ No defect of operational function in room temperature are allowable(23±5°C). ◦ Leakage current should be below double of initial value.
2	Low Temperature Operating	-20°C 240 hrs	
3	High Temperature Non-Operating	+80°C 240 hrs	
4	Low Temperature Non-Operating	-30°C 240 hrs	
5	High Temperature/Humidity Non-Operating	50°C ; 90%RH ; 240 hrs	
6	Temperature Shock Operating	-30°C ↔ 80°C (30min) (5min) (30min) 10CYCLES	
7	Electro-static Discharge	HBM : ±2kv	

Note 1: Test after 24 hours in room temperature(23±5°C).

Note 2: The sampling above is individually for each reliability testing condition.

Note 3: The color fading of polarizing filter should not care.

Note 4: All of the reliability testing chamber above, is using D.I. water.(Min value:1.0 MΩ -cm)

Note 5: In case of malfunction defect caused by ESD damage, if it would be recovered to normal state after resetting, it would be judged as a good part.

10.3. Color Performance

No.	ITEM	Criterion (initial)
1	Luminance	>50%
2	NTSC	>70%
3	Contrast Ratio	>50%



KYOCERA Display Corporation

11. INSPECTION CRITERIA

11.1. Inspection Conditions

11.1.1. Environmental conditions

The environmental conditions for inspection shall be as follows

Room temperature: $23\pm 5^{\circ}\text{C}$

Humidity: $50\pm 20\%RH$

11.1.1. The external visual inspection

With a single 1000 ± 200 lux fluorescent lamp as the light source, the inspection was in the distance of 30cm or more from the LCD to the inspector's eyes.

11.2. Light Method

11.2.1. Environment lamp under 1000 ± 200 lux, Viewing direction for inspection

over 300mm

11.2.2. The distance from eye to defect around 300mm, the distance from ND Filter

to defect around 25~30mm

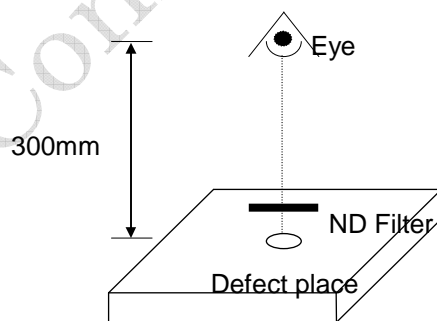

11.3. Classification Of Defects

11.3.1. Major defect

A major defect refers to a defect that may substantially degrade usability for product applications.

11.3.2. Minor defect

A minor defect refers to a defect which is not considered to be able substantially degrade the product application or a defect that deviates from existing standards almost unrelated to the effective use of the product or its operation.

Notes: If the LCD/LCM 's cosmetic and display performance do not specify in "inspection criterion", it should be based on these delivered samples.

11.4. Sampling & Acceptable Quality Level

Level II, MIL-STD-105E

	Major	Minor
Cosmetic	1.0 %	1.5 %
Electrical-display	0.4%	0.65 %

11.5. Definition Of Inspection Area

V.A: Viewing Area

A.A: Active Area

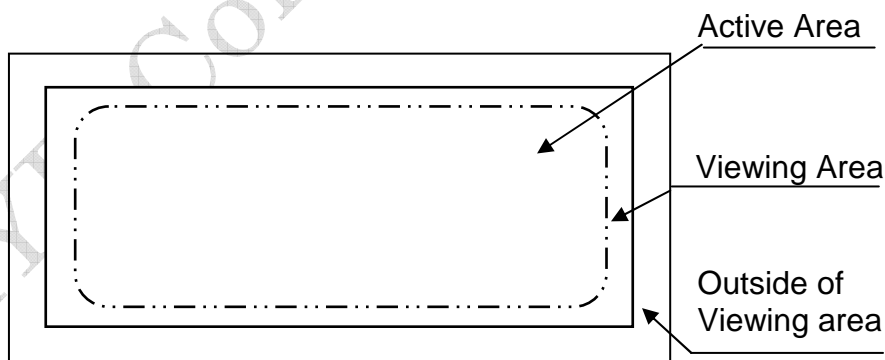



KYOCERA Display Corporation

11.6. Items and Criteria

11.6.1. Visual inspection criterion in cosmetic

(1) Glass defect

No	Defect	Criteria	Remark
1	Dimension (Minor)	By engineering diagram	
2	Cracks (Major)	Extensive crack 【Reject】	

(2) LCM appearance defect

No	Defect	Criteria	Remark	
1	Round type (Minor)	Spec.	Permissible Qty	1. $\psi = (L+W)/2$, L: Length, W: Width 2. Disregard if out of A.A.
		$\psi \leq 0.10\text{mm}$	Disregard	
		$0.10\text{mm} < \psi \leq 0.20\text{mm}$	3	
		$0.20\text{mm} < \psi$	0	
2	Line type (Minor)	Spec.	Permissible Qty	1. L: Length, W: Width 2. Disregard if out of A.A.
		$W \leq 0.03\text{mm}$	Disregard	
		$L \leq 3.0\text{mm}$ and $0.03\text{mm} < W \leq 0.05\text{mm}$	2	
		$L \leq 3.0\text{mm}$ and $0.05\text{mm} < W \leq 0.10\text{mm}$	1	
		$W > 0.10\text{mm}$ or $L > 3.0\text{mm}$	0	
3	Polarizer dent (Minor)	Spec.	Permissible Qty	1. $\psi = (L+W)/2$, L: Length, W: Width 2. Disregard if out of A.A.
		$\psi \leq 0.20\text{mm}$	Disregard	
		$0.20\text{mm} < \psi \leq 0.30\text{mm}$	2	
		$0.30\text{mm} < \psi \leq 0.50\text{mm}$	1	
		$0.50\text{mm} < \psi$	0	



KYOCERA Display Corporation

(3) FPC

No	Defect	Criteria	Remark
1	Copper peeling (Minor)	Copper peeling 【Reject】	

(4) Black tape

No	Defect	Criteria	Remark
1	Shift (Minor)	IC exposed 【Reject】	
2	No black tape (Minor)	No black tape 【Reject】	

(5) Silicon

No	Defect	Criteria	Remark
1	Amount of silicon (Minor)	ITO exposed 【Reject】	

(6) Bezel

No	Defect	Criteria	Remark
1	Oxidized spot (Minor)	Oxidized spot, rust 【Reject】	
2	Outline deformation (Minor)	By engineering diagram	
3	Greasiness (Minor)	Greasiness 【Reject】	
4	Spots, round Type (Minor)	$H \leq$ By engineering diagram 【Disregard】	H=Total height (thickness)
5	Plating (Minor)	Bubble, peeling 【Reject】	

(7) Power cord

No	Defect	Criteria	Remark
1	Power cord (Minor)	Power core loose	

11.6.2. Visual inspection criterion in electrical display

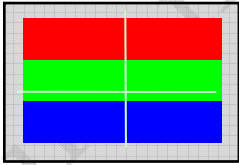
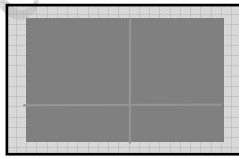
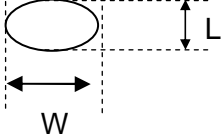
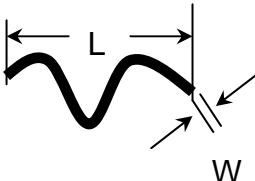
No	Defect	Criteria		Remark
1	No display (Major)	Not allowed		
2	Missing line (Major)	Not allowed		
3	Darker or lighter line (Major)	Not allowed		
4	Bright / Dark point (Minor)	Spec.	Permissible Qty	1:1sub-pixel: 1R or 1G or 1B 2:Point defect area \geq 1/2 sub pixel.
		Bright point	1	
		Dark point	2	
5	Round type (Minor)	Spec.	Permissible Qty	1. $\psi = (L+W)/2$, L: Length, W: Width 2. Disregard if out of A.A. 
		$\psi \leq 0.10\text{mm}$	Disregard	
		$0.10\text{mm} < \psi \leq 0.20\text{mm}$	3	
		$0.20\text{mm} < \psi$	0	
7	Line type (Minor)	Spec.	Permissible Qty	1. L: Length, W: Width 2. Disregard if out of A.A. 
		$W \leq 0.03\text{mm}$	Disregard	
		$L \leq 3.0\text{mm}$ and $0.03\text{mm} < W \leq 0.05\text{mm}$	2	
		$L \leq 3.0\text{mm}$ and $0.05\text{mm} < W \leq 0.10\text{mm}$	1	
		$W > 0.10\text{mm}$ or $L > 3.0\text{mm}$	0	
8	Mura (Minor)	By 5% ND filter invisible		



KYOCERA Display Corporation

11.6.3. Others

1. Issues that are not defined in this document shall be discussed and agreed with both parties. (Customer and supplier)
2. Unless otherwise agreed upon in writing, the criteria shall be applied to both parties. (Customer and supplier)

12. ILLUSTRATION OF LCD DATE CODE

(TBD)

KYD Confidential Document



KYOCERA Display Corporation

13. RoHS COMPLIANT WARRANTY

RoHS Hazardous substances including:

- Cd < 100 ppm
- Pb < 1000 ppm
- Hg < 1000 ppm
- Cr +6 < 1000 ppm
- PBDE < 1000 ppm
- PBB < 1000 ppm

14. PRECAUTIONS FOR USE

14.1. Safety

- (1) Do not swallow any liquid crystal, even if there is no proof that liquid crystal is poisonous.
- (2) If the LCD panel breaks, be careful not to get liquid crystal to touch your skin.
- (3) If skin is exposed to liquid crystal, wash the area thoroughly with alcohol or soap.

14.2. Storage Conditions

- (1) Store the panel or module in a dark place where the temperature is $23\pm 5^{\circ}\text{C}$ and the humidity is below $50\pm 20\%\text{RH}$.
- (2) Store in anti-static electricity container.
- (3) Store in clean environment, free from dust, active gas, and solvent.
- (4) Do not tear off the vacuum treatment package before assembling.
- (5) Do not place the module near organics solvents or corrosive gases.
- (6) Do not crush, shake, or jolt the panel or module.
- (7) Do not exposed to direct sun light of fluorescent lamps.

14.3. Installing LCD Module

Attend to the following items when installing the LCM.

- (1) Cover the surface with a transparent protective plate or touch panel to protect the polarizer and LC cell.
- (2) When assembling the LCM into other equipment, the spacer to the bit between the LCM and the fitting plate should have enough height to avoid causing stress to the module surface, refer to the individual specifications for measurements. The measurement tolerance should be $\pm 0.1\text{mm}$.



KYOCERA Display Corporation

14.4. Precautions For Operation

- (1) Viewing angle varies with the change of liquid crystal driving voltage (V_o). Adjust V_o to show the best contrast.
- (2) Driving the LCD in the voltage above the limit will shorten its lifetime.
- (3) Response time is greatly delayed at temperature below the operating temperature range. However, this does not mean the LCD will be out of the order. It will recover when it returns to the specified temperature range.
- (4) When turning the power on, input each signal after the positive/negative voltage becomes stable.
- (5) Do not apply mater or any liquid on product, which composed of T/P.

14.5. Handling Precautions

- (1) Avoid static electricity that can damage the CMOS LSI; please wear the wrist strap when handling.
- (2) The polarizing plate of the display is very fragile. So, please handle it very carefully.
- (3) Do not give external shock.
- (4) Do not apply excessive force on the surface; it may cause display abnormal.
- (5) Do not wipe the polarizing plate with a dry cloth, as it may easily scratch the surface of plate.
- (6) Do not use ketonics solvent & Aromatic solvent, use with a soft cloth soaked with a cleaning naphtha solvent.
- (7) Do not operate it above the absolute maximum rating.
- (8) Do not remove the panel or frame from the module.
- (9) Do not apply mater or any liquid on product, which composed of T/P.



KYOCERA Display Corporation

14.6. Guarantee

- 14.6.1. The period is within 12 months since the date of shipping out under normal using and storage conditions.
- 14.6.2. Any defect not caused by Kyocera Display is not guaranteed to the customer. The defect phenomenon should be agreed by both parties.

15. FACTORY

(TBD)

16. REVISION HISTORY

Version	Revise record	Date
A	New version	2012/03/12
B	Viewing Direction remark	2012/04/24
B	Type No. Change "GD032JU-LW" → "GD032J-LW"	2012/04/24